



Product catalogue

ABB AS, Electrification Products division

Gas-insulated ring main unit type SafeRing 12 - 24 kV and  
Gas-insulated compact switchgear type SafePlus 12 - 24 kV

Power and productivity  
for a better world™



# Content

1	Introduction .....	4
2	Design philosophy .....	7
3	Outer assembly.....	8
4	Inner design.....	8
5	Production .....	9
5.1	Completely sealed system .....	9
5.2	Fully routine tested .....	10
6	Safety .....	10
6.1	Internal Arc Classification (IAC).....	10
6.2	Arc suppressor .....	15
6.3	Interlocking and locking .....	16
7	Applications SafeRing / SafePlus .....	17
8	Applications SafeRing .....	18
8.1	SafeRing configurations .....	19
8.2	Technical data SafeRing .....	22
9	SafePlus modules .....	23
9.1	Applications SafePlus .....	24
9.2	C - Cable switch module .....	25
9.2.1	C - Cable switch module - Technical data.....	26
9.2.2	C - Cable switch module - Interlocking .....	27
9.3	F - Switch-fuse module .....	28
9.3.1	F - Switch-fuse module - Technical data.....	29
9.3.2	F - Switch-fuse module - Interlocking .....	30
9.4	V - Vacuum circuit-breaker module .....	31
9.4.1	V - Vacuum circuit-breaker module - Technical data.....	32
9.4.2	V - Vacuum circuit-breaker module - Interlocking .....	33
9.5	V - Vacuum circuit-breaker module V25 / V20 .....	34
9.6	SI - Busbar sectionalizer module .....	35
9.7	Sv - Busbar sectionalizer module .....	36
9.8	Sv - Busbar sectionalizer module Sv25 / Sv20 .....	37
9.9	D - Direct cable connection module .....	38
9.10	De - Direct cable connection module with earthing switch .....	39
12.10.1	De - module - Interlocking .....	40
9.11	Be - Busbar earthing module.....	41
9.12	CB - Circuit-breaker module .....	42
9.12.1	CB - Circuit-breaker module - Interlocking .....	43
9.13	M - Metering module .....	44
9.14	Mt - Metering tariff module .....	46

10	Mini-metering (integrated metering) .....	47
	10.1 Mini-metering - current transformers.....	48
11	Measuring transformers .....	49
12	Combisensor .....	51
13	SeSmart .....	52
14	Mechanisms .....	54
15	Cable bushings .....	57
16	Cable termination .....	58
	16.1 Cable terminations 12kV.....	61
	16.2 Cable terminations 24kV.....	63
17	Cable test bushings .....	65
18	Extension of switchgear .....	66
	18.1 External busbars on top .....	66
	18.2 Side extension .....	67
19	Base frame .....	68
20	Low voltage compartment / Top entry box .....	69
21	Motor operation .....	70
22	Transformer protection .....	72
23	Fuse-links .....	73
	23.1 Fuse selection table CEF .....	74
	23.2 Fuse selection table CEF-S .....	75
24	Relays .....	76
25	Capacitive voltage indicators .....	83
26	Short-circuit indicators .....	85
27	Manometers/Pressure indicators.....	87
28	Key interlocks .....	89
29	Smart Grid applications .....	91
30	Marine applications .....	97
	30.1 Marine applications IAC AFL .....	98
31	Low version switchgear .....	99
32	Dimensions .....	100
33	Technical data .....	108
35	Environmental certification .....	117

# 1 Introduction

SafeRing and SafePlus switchgear for secondary distribution were developed by ABB in Skien and introduced to the markets in 2000, replacing the previous SF<sub>6</sub>-insulated products RGC and CTC. The installed base of SafeRing / SafePlus is more than 150 000 switchgears in more than 100 countries all over the world.

The switchgear portfolio is constantly under development to adjust to new market requirements and customers' needs.

SafeRing is available in standard configurations based on a high-volume production. These standardized RMUs, which are the most required configurations within a distribution network, can be extendable upon request.

SafePlus is the switchgear version of SafeRing with flexibility, modularity and higher ratings.

## Customer benefits

- A wide range of functional units, easy to extend and upgrade
- Up to five modules in one common gas tank
- No live parts exposed
- Fully sealed for lifetime
- Climatically independent
- Designed and tested according to IEC
- High reliability and safety
- Compact dimensions
- Safe and easy for operators in both maintenance and operating conditions
- All operations are carried out from the front of the switchgear
- Maintenance free



# 1 Introduction



## Applicable standards

SafeRing/SafePlus is tested according to following IEC-standards:

- IEC 62271-1: Specifications High-voltage switchgear
- IEC 62271-100: Alternating-current circuit-breakers
- IEC 62271-102: Alternating current disconnectors earthing switches
- IEC 62271-103: High-voltage switches
- IEC 62271-105: Switch-fuse co-operation
- IEC 62271-200: Arc fault and switchgear
- IEC 60529: Degrees of protection provided by enclosures

SafeRing/SafePlus is also tested together with CSS according to IEC 62271-202 standard. Tests have been performed on CSS from various manufacturers.

## Industry

- Pulp and Paper
- Cement
- Textiles
- Chemicals
- Food
- Automotive
- Petrochemical
- Quarrying
- Oil and gas pipelines
- Rolling mills
- Mines

## Utilities and Power Plants

- Power generation stations
- Transformer stations and metering
- Main and auxiliary switchgear

## Transport

- Airports
- Ports
- Railways
- Underground transport

## Infrastructure

- Supermarkets
- Shopping malls
- Hospitals
- Large infrastructure and civil works

## Normal operation conditions

The rated characteristics of the switchgear are valid under the following ambient conditions:

- minimum ambient temperature:  $-25\text{ }^{\circ}\text{C}$
- maximum ambient temperature:  $+40\text{ }^{\circ}\text{C}$

For different temperature ranges, please contact your ABB sales representative.

## Ambient humidity:

- maximum 24 h average of relative humidity 95%
- maximum 24 h average of water vapour pressure 2.2 kPa
- maximum monthly average of relative humidity 90% RH
- maximum monthly average of water vapour pressure 1.8 kPa

The normal operational altitude is up to 1,500 m above sea level. For higher altitude applications, please contact your ABB sales representative.

The switchgear is designed for operation in normal, non-corrosive and uncontaminated atmosphere.

# 1 Introduction

## General

SafeRing is a SF<sub>6</sub>-insulated ring main unit for the secondary distribution network. SafeRing can be supplied in 10 different configurations suitable for most switching applications in 12/24 kV distribution networks. As an option, SafeRing can be delivered as extendable ring main unit.

SafePlus is ABB's flexible, extendable compact switchgear. Together, SafeRing and SafePlus represent a complete solution for 12/24 kV secondary distribution networks. SafeRing and SafePlus have identical user interfaces.

SafeRing/SafePlus is a completely sealed system with a stainless steel tank containing all the live parts and switching functions. A sealed steel tank with constant atmospheric conditions ensures a high level of reliability as well as personnel safety and a virtually maintenance-free system.

The SafeRing concept offers a choice of either a switch fuse combination or circuit breaker with relay for protection of the transformer. SafeRing can be supplied with an integrated remote control and monitoring unit.

SafePlus is a SF<sub>6</sub>-insulated, extendable compact switchgear system for secondary distribution. The switchgear has a unique flexibility due to its extendability and the possible combination of fully modular and semi modular configurations. When combined with SafeRing, which is ABB's standard ring main unit, they represent a complete solution for 12/24 kV distribution networks.

## Modularity and external busbar

All modules except the metering module and circuit-breaker module are only 325 mm wide.

SafePlus can be configured with a maximum of five modules in one SF<sub>6</sub> tank with an internal busbar. To configure switchgear with more than five modules as many tanks as needed can be joined together by use of an external busbar. Alternatively, the whole switchgear can be configured as fully modular with the use of the external busbar between all modules. The external busbar is fully insulated and screened in order to maintain climatic independence and a maintenance free solution. All modules can be delivered prepared for future extension.

## Transformer protection

SafePlus offers a choice between a switch fuse combination and circuit breaker with relay for transformer protection. The switch fuse combination offers optimal protection against short-circuits, while the circuit breaker with relay option offers better protection against low overcurrents. Circuit breaker with relay is always recommended for larger transformers.



## 2 Design philosophy

### SafeRing and SafePlus – ABB switchgear for secondary distribution

Secondary distribution switchgears have been subject to a significant development the past 20 years, resulting in increased functionality and smaller dimensions.

The traditional switching cells are substituted with complete switchgear systems. Specific functions such as grounding, disconnecting, cable connections, busbar extension, protection and switching have become integrated features in compact functional units.

Compact switchgear systems meet customers' MV application needs. ABB has always been a part of this development.

The current ABB SafePlus range satisfies the most complex system specifications.

The most unique specialization is the development of the cable ring switchgear. The numerous public distribution substations requested a unified switching functionality which evolved into the ring main unit concept.

ABB SafeRing range is one major contributor to this specialization.

### Two Products – One range

ABB SafeRing is adapted to the needs in the immense utility distribution network.

ABB SafePlus offers more in terms of flexibility and electrical capacity.

Both switchgear offer the same customer interface.

### Customers' involvement

The applied functionality in ABB SafeRing and SafePlus is a result of input from customers all over the world.

Key customers are continuously involved with ABB design staff to ensure optimized switchgear operation. The functionality will always find its background from customer demands.

### Personnel – safety and service

Safety is not only a specification and rating issue, but also a real life experience.

Standards and associated testing will disclose weakness at the time of testing. ABB takes this further to be an objective related to durability and repetitive manufacturing quality.

All products are manufactured in accordance with ISO 9001. The latest edition of relevant IEC standards will always apply to our continuous product development and test program. "Integrated functionality" is a key objective to reduce the number of moving components, further reducing the risk of any mechanical defect.

### We are responsible for the environment

The location for manufacturing SafeRing and SafePlus is Norway. Norway's green policy contributes to focus on environmental factors in manufacturing as well as over the switchgears life span.

All products are manufactured in accordance with our ISO 14001 certification.

Recycling is confirmed at a 97% level.

To simplify this process, we will continuously work with our partners to develop routines for handling end of life.

Plastic parts are individually marked to simplify the recycling process.

Solutions for elimination of gas emission in the rare event of a fault can be supplied.

### Modern - development and manufacturing

Numerical simulations together with long experience will ensure compact and robust design.

Dielectric simulations will ensure that compactness will not influence the dielectric capability.

The combination of design techniques, experience and the most modern production technology guarantee state of the art products and durability.

### Complete solutions – one supplier

Complex applications involving different standard remote levels, such as monitoring, control measurement and protection can now be supplied from one supplier.

This makes large scale implementation feasible and will simplify engineering and procurement.

The control and monitoring unit available for SafeRing is located behind the front cover. This option is also readily available for retrofitsince such demands normally evolve after the switchgear is in service.

### 3 Outer assembly

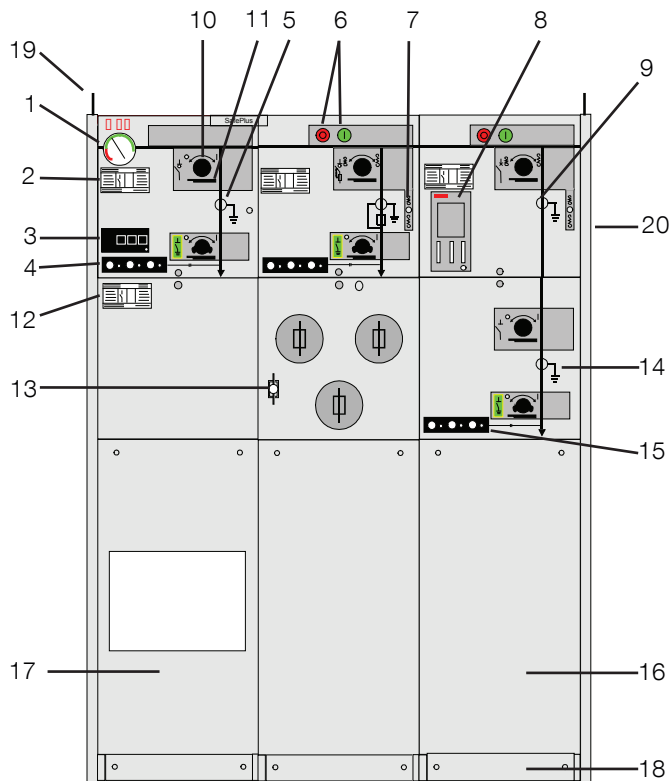

#### Upper front cover

1. Manometer
2. Nameplate module
3. Short circuit indicator
4. Capacitive voltage indication
5. Load break / earthing switch position indicator
6. Push buttons close/open operation
7. Charged spring indicator
8. Self-powered protection relay
9. Vacuum circuit-breaker position
10. Operation shaft
11. Padlock device

#### Lower front cover

12. Nameplate switchgear
13. Fuse blown indicator
14. Disconnecter / earthing switch position indicator
15. Capacitive voltage indication

#### Cable compartment cover

16. Cable compartment cover standard
17. Cable compartment cover with inspection window
18. Support bar (removable)

#### Side cover

19. Lifting lug
20. Operating handle (standard on right hand side)

### 4 Inner design

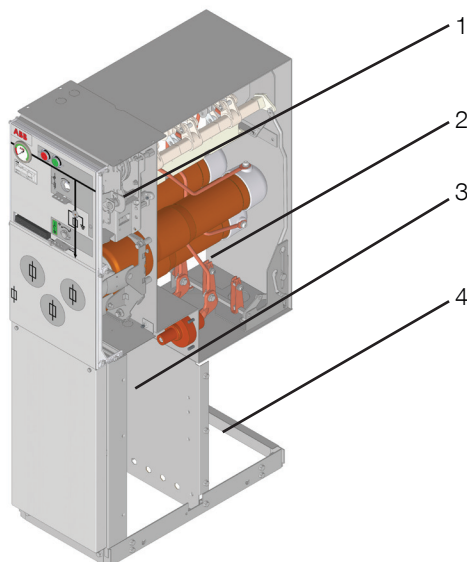

1. Mechanism compartment
2. SF<sub>6</sub> gas tank
3. Cable compartment
4. Pressure relief area



## 5 Production

### 5.1 Completely sealed system

#### Exterior construction

Upper and lower front cover have a thickness of 3 mm aluminium which is covered with a polycarbonate foil. These foils contain the mimic diagram of the main circuit integrated with the position indicators for the switching devices. Background colour for these foils is light grey (RAL 7035). The upper front cover is removable. The lower front cover can be opened.

There are four different cable compartment covers: standard, with inspection window, arc proof and with extra depth for parallel cables. These covers are manufactured from 1.5 mm aluzink (except the arc proof cover) and are powder painted with colour RAL 7035.

All cable compartment covers are removable. Each module has a separate cable compartment which is divided from the others by means of partition walls. These partition walls can easily be removed, allowing a comfortable access for connection of cables.

A vertical partition wall is fitted to divide the cable compartment(s) from the rear side of the switchgear / ring main unit.

In case of an arc fault inside the SF<sub>6</sub> tank, followed by an opening of the pressure relief in the bottom of the tank, this partition wall will prevent the hot gases blowing out from the pressure relief to enter the cable compartments. Side covers are made of 2 millimeter hot rolled steel and powder painted with colour RAL 7035.

#### Enclosure

SafeRing and SafePlus use SF<sub>6</sub>-gas (Sulphur hexafluoride) as insulation and quenching medium.

The SF<sub>6</sub> is contained in a welded stainless steel tank, which is sealed for life.

The pressure system is defined as a sealed for life system with an operating life time exceeding 30 years. The leakage rate is less than 0,1% per year.

In order to ensure a reliable and tight welding, all welding work is carried out by computer controlled robots. Electrical and mechanical bushings penetrating the tank are clamped and sealed to the tank by high quality O-rings.

The mechanical bushing has in addition a rotating shaft which connects the shaft of the switch to the corresponding shaft of the mechanism. The rotating shaft is sealed by a double set of gas seals.

All SF<sub>6</sub>-tanks have to pass a leakage test before gas filling. Leakage test and gas filling are done inside a vacuum chamber. The first step in the leakage test is to evacuate all air inside both SF<sub>6</sub>-tank and vacuum chamber simultaneously. Then the SF<sub>6</sub>-tank is filled with Helium. Due to the characteristics of Helium this test will detect all possible leakages. If the SF<sub>6</sub>-tank passes this test, the Helium will be evacuated and replaced by SF<sub>6</sub>.

The SF<sub>6</sub>-tank has a degree of protection of IP67 and can be immersed into water and still maintain all functions in a satisfactory way.

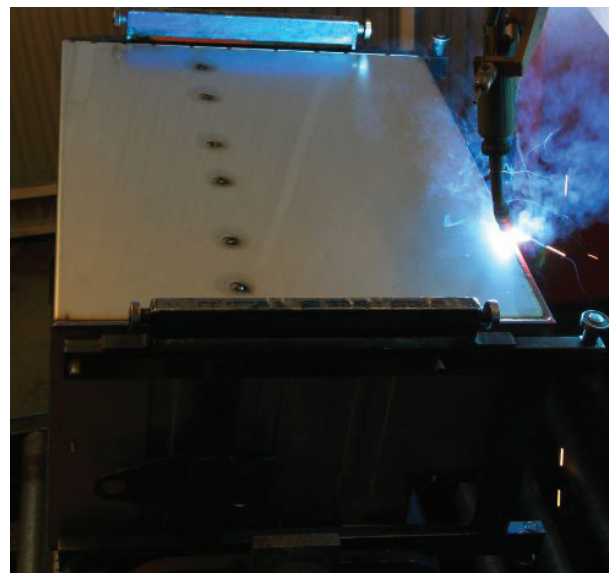

## 5.2 Fully routine tested

ABB has set a high quality automated system for production and quality control which assures sustainability of factory output. Part of the assurance is standard routine testing procedures according to IEC62271-200 performed on every manufactured switchgear.

### IEC factory routine tests:

- Visual inspection and check
- Mechanical operations check
- Check of secondary wiring
- Electrical sequence operations
- Power frequency withstand voltage test
- Partial discharge measurement
- Measurement of resistance of the main circuits
- Secondary insulation test
- Control of the gas tightness

### State of the art

For the routine testing, ABB is using the latest technologies and systems as for example:

- Fully automated high voltage testing cabin
- Temperature compensated gas filling system
- Automated connection counting system
- Automated screw torque control
- Computer aided mechanical characteristics control

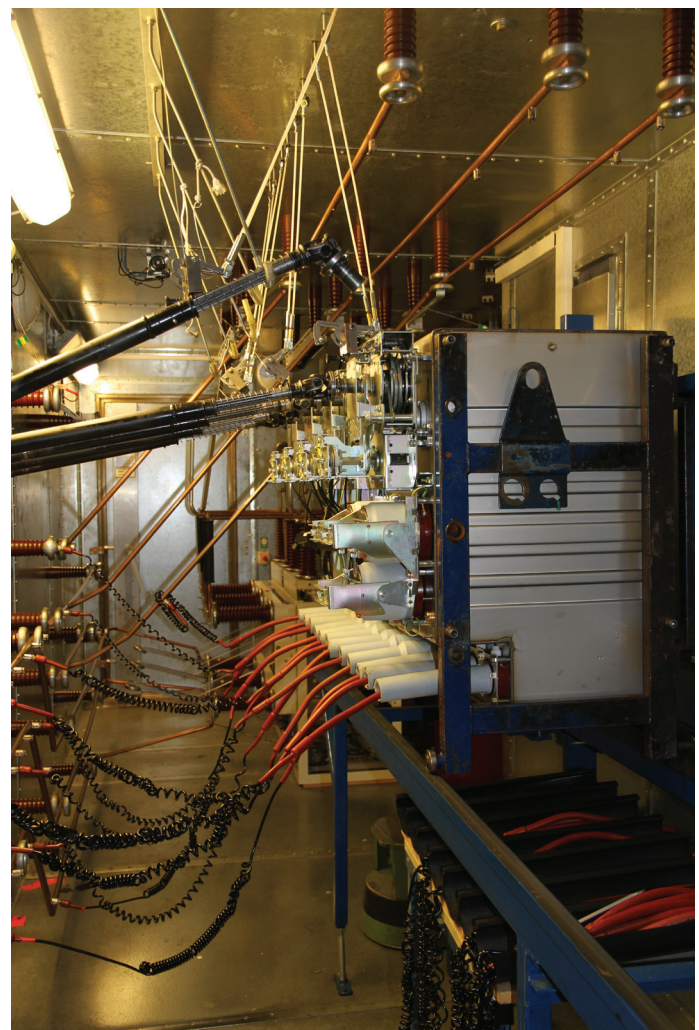
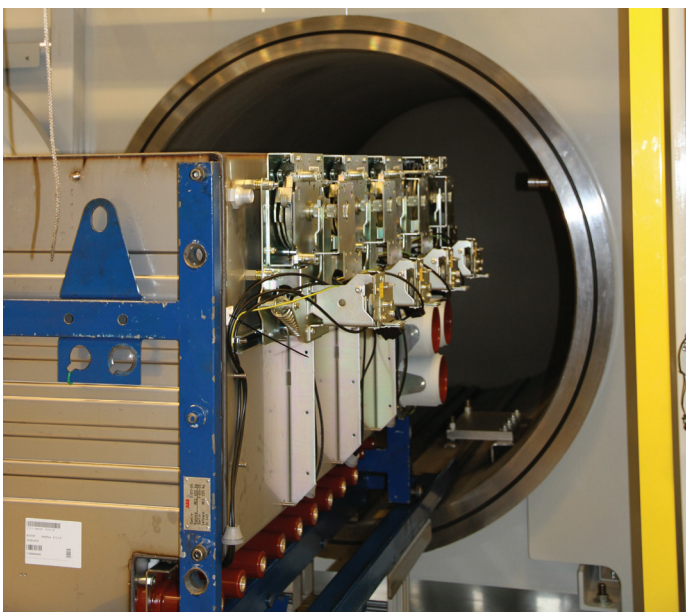

## 6 Safety

### 6.1 Internal Arc Classification (IAC)

During development of all ABB products, focus is put on personnel safety. This is why the SafeRing/SafePlus portfolio was designed and tested for a variety of internal arc scenarios in order to withstand internal arc of same current level as a maximum short circuit current. The tests show that the metal enclosure of SafeRing/SafePlus switchgear is able to protect personnel standing close to the switchgear during internal arc fault.

#### Causes and effects of IAC

An internal arc is a highly unlikely fault, although it can theoretically be caused by various factors, such as:

- Insulation defects due to quality deterioration of the components. The reasons can be adverse environmental conditions and a highly polluted atmosphere.
- Inadequate training of the personnel in charge of the installation leading to incorrect installation of the cables.
- Breakage or tampering of the safety interlocks.
- Overheating of the contact area, e.g. when the connections are not sufficiently tightened.
- Short circuits caused by small animals that has entered into the cable compartment (i.e. through cable entrance).

The energy produced by the internal arc causes the following phenomena:

- Increase of the internal pressure.
- Increase of the temperature.
- Visual and acoustic effects.
- Mechanical stresses on the switchgear structure.
- Melting, decomposing and evaporation of materials.

#### Tested according to IEC standard 62271-200

Capability of SafeRing/SafePlus switchgear to withstand internal arc is proven by the type test according to Internal arc classification (IAC) as described in the standard IEC 62271-200 as follows:

Accessibility: A, B or C (switchgear)

A=Accessible to authorized personnel only

B=public access

C=not accessible due to installation

F-Front=Access from the front

L-Lateral=Access from sides

R-Rear=Access from the rear

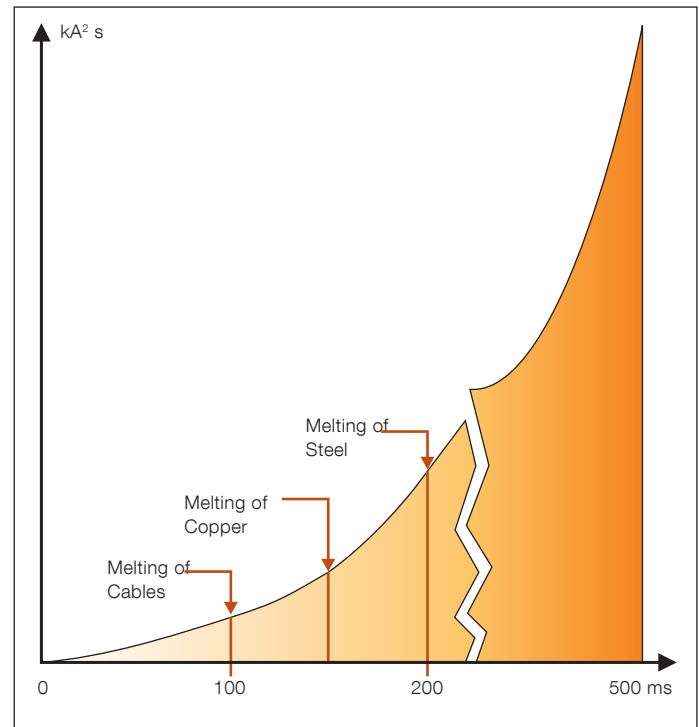

Arc duration and damage caused

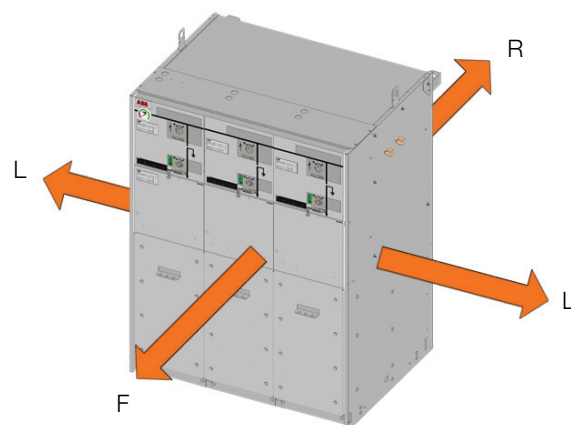

All test specimens passed the following test criteria according to the standards:

1. Correctly secured doors and covers do not open
2. No fragmentation of the enclosure occurs within the time specified for the test. Projection of small parts up to an individual mass of 60 g are accepted
3. Arcing does not cause holes in the enclosure of the switchgear up to a height of 2 m
4. Indicators do not ignite due to the effect of hot gases
5. The enclosure remains connected to its earthing point

## 6.1 Internal Arc Classification (IAC)

SafeRing/SafePlus is available for a wide range of installations and applications in order to secure the highest safety for operators. Switchgears are designed and type-tested for internal arc classification according to the following configurations:

### 6.1.1 IAC AFLR - with ventilation upwards through exhaust channel

With this setup, hot gases and pressure are evacuated through the gas exhaust channel above the switchgear into the safe area of the switchgear room. In this setup the switchgear can be installed as free standing. This solution is not available for M-module.

With this solution, a base frame of 450 mm (optional 290 mm) is included as standard.

Basic parameters of setup:

- IAC AFLR up to 25 kA / 1s
- Minimum height of ceiling: 2600 mm
- Recommended distance to backwall: 100 mm

For number of modules, availability, heights and specifications, see table no. 6.1.1.

### 6.1.2 IAC AFL - with ventilation down to the cable trench

With this setup, hot gases and pressure are evacuated downwards in the cavity in the floor. The size of the hole needs to be at least 1m<sup>3</sup>. The cable trench should be at least 2 meters long, with an opening of minimum 0.5 m<sup>2</sup>. Hot gases are led to the cable trench by means of a back plate installed on the rear side of the cable compartment. This solution is not available for M-module.

Basic parameters of set-up:

- IAC AFL up to 20 kA / 1s
- Minimum height of ceiling: 2000 mm
- Cable trench volume minimum 1m<sup>3</sup>. Pressure relief channel to safe area is required
- Distance to backwall: 100 mm

For number of modules, availability, heights and specifications, see table no. 6.1.1.

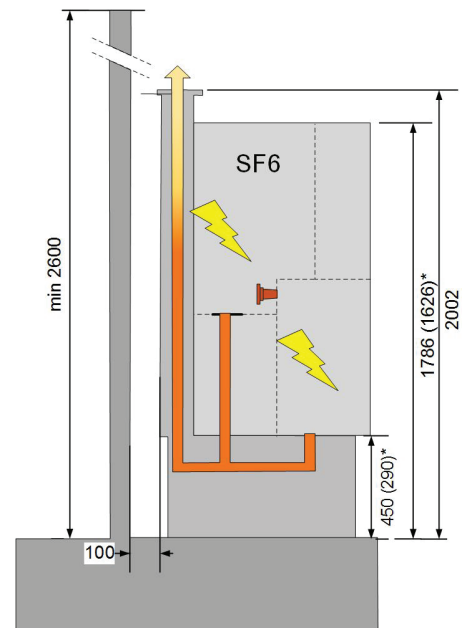

\* 290 mm base frame available as option.

Note:

Height of exhaust channel is always 2002 mm, according to requirements in IEC standards. When base frame is 290 mm, the exhaust channel is extended to reach 2002 mm height

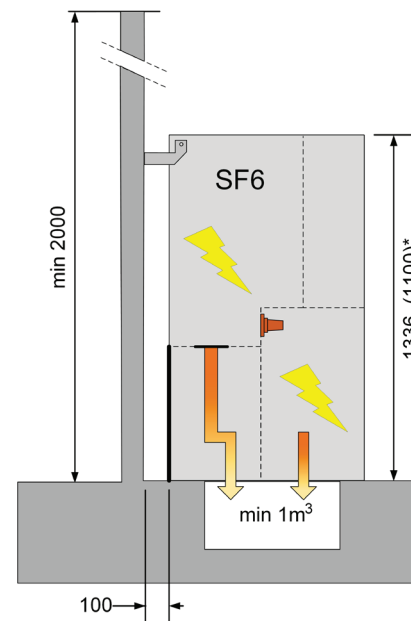

1100 mm version available as option

# 6.1 Internal Arc Classification (IAC)

## 6.1.3 IAC AFL - with ventilation behind the switchgear

With this setup, hot gases and pressure are evacuated behind the switchgear, either if the arc fault occurs inside the SF<sub>6</sub>-tank or in the cable compartment. Hot gases are led to the safe areas of the switchgear room by means of arc shields installed on each side of the switchgear.

Basic parameters of setup:

- IAC AFL up to 20 kA / 1s
- Minimum height of ceiling: 2400 mm
- Distance to backwall: 100 mm
- Distance from sidewall: 20 mm. If installed more than 20 mm from sidewall, an arc shield is required. For easier installation, it is recommended that any switchgear requiring arc shields is installed minimum 300 mm from sidewall.

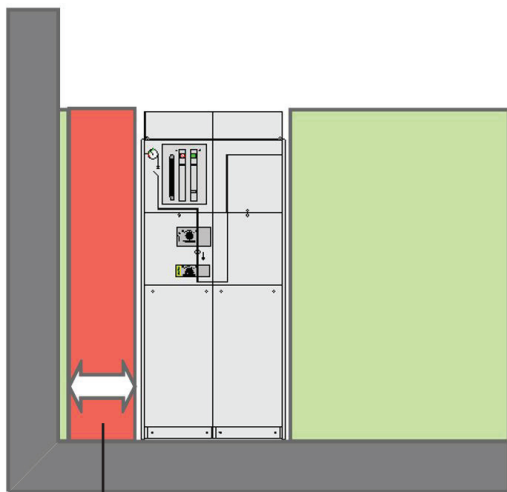

20 - 300 mm

Marked area is restricted, but installation is allowed if mounting of arc shield is feasible.

For number of modules, availability, heights and specifications, see table no. 6.1.1.

## 6.1.4 Non-arc proof version

The non-arc proof version of the switchgear is not verified for any of the IAC-classes. In the highly unlikely event of an internal arc fault in the switchgear, hot gases and pressure could evacuate randomly in any direction at any place of enclosure.

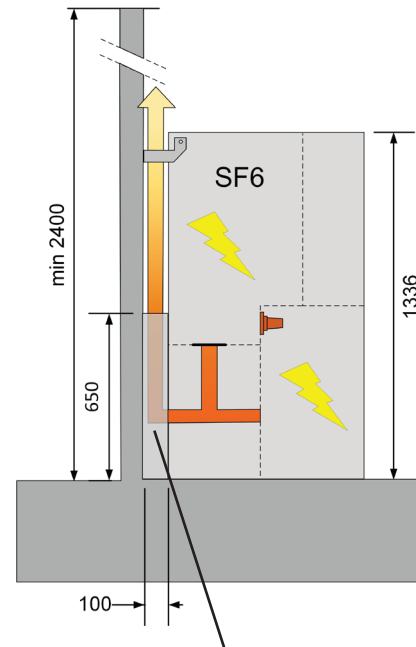

Arc shield  
Height of arc shield for M-module is 1317 mm.

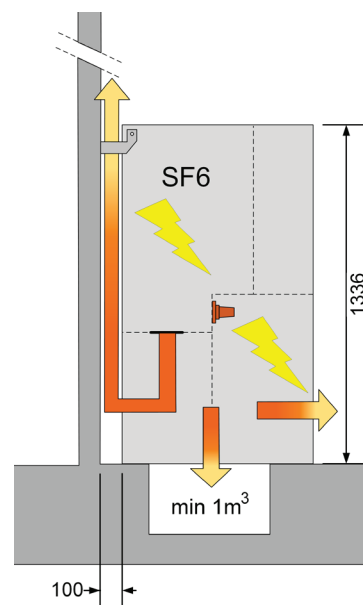

1100 mm version available as option.

## 6.1 Internal Arc Classification (IAC)

Table 6.1.1

ISC (kA/1s)	IAC class	Ventilation	Height of switchgear (mm)	Roof height (mm)	Arc suppressor	Base frame	Max sets of current transformers	Number of modules
16	AFL	Backwards	1336 (standard) 1100 (low)	2400 (standard) 2400 (low)	optional	optional (290/450 mm) <sup>4)</sup>	2 <sup>2)</sup>	1 - 5
	AFL	Downwards <sup>3)</sup>	1336 (standard) 1100 (low)	2000 (standard) 2000 (low)	optional	optional (290/450 mm) <sup>4)</sup>	2 <sup>2)</sup>	1 - 5
	AFLR	Upwards <sup>5)</sup>	1786 <sup>1)</sup>	2600	optional	mandatory (450/290 <sup>6)</sup> mm)	2 <sup>2)</sup>	2 - 5
20	AFL	Backwards	1336 (standard) 1100 (low)	2400 (standard) 2400 (low)	optional	optional (290/450 mm) <sup>4)</sup>	2 <sup>2)</sup>	2 - 5
	AFL	Downwards <sup>3)</sup>	1336 (standard) 1100 (low)	2000 (standard) 2000 (low)	optional	optional (290/450 mm) <sup>4)</sup>	2 <sup>2)</sup>	2 - 5
	AFLR	Upwards <sup>5)</sup>	1786 <sup>1)</sup>	2600	optional	mandatory (450/290 <sup>6)</sup> mm)	2 <sup>2)</sup>	2 - 5
25	AFLR	Upwards	1786 <sup>1)</sup>	2600	on request	mandatory (450 mm)	2 <sup>2)</sup>	2 - 5

<sup>1)</sup> Height of exhaust channel is 2002 mm. This dimension is independent of the height of the base frame. If base frame is 290 mm, exhaust channel is extended to reach 2002 mm

<sup>2)</sup> In case two sets of CT's are required, additional base frame is mandatory. Second set of CT's will be installed in base frame

<sup>3)</sup> IAC classification is unavailable in case of use of gland plates

<sup>4)</sup> If base frame is added, roof height needs to be 2400 mm

<sup>5)</sup> Not allowed with gland plate between switchgear and base frame, gland plate can be installed below base frame

<sup>6)</sup> 290 mm base frame as option

## 6.2 Arc suppressor

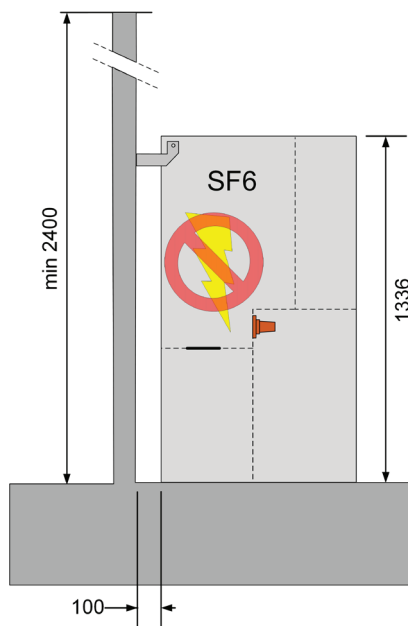
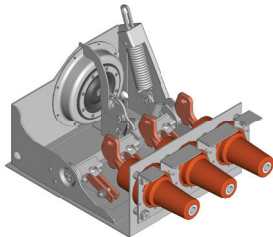

From IAC-test without arc suppressor



From IAC-test with arc suppressor

### Arc suppressor - active device for increased safety

The arc suppressor is an optimal quick-make short circuit device with a mechanical pressure detector which can be installed in each incoming feeder inside the sealed SF<sub>6</sub>-tank of SafeRing and SafePlus switchgear.

If an arc fault should occur inside the SF<sub>6</sub>-tank the pressure device of the arc suppressor will automatically trip and short circuit the incoming feeder(s) within milliseconds, thereby extinguishing the arc and preventing a gas blowout. The arc is extinguished without any emission of hot gases and the bolted short circuit will be interrupted by the upstream circuit-breaker.

No links or release mechanisms are installed outside the tank. Corrosion and any environmental influences are therefore prevented, giving optimum reliability.

The pressure detector is insensitive to pressure changes due to variation in atmospheric temperature or pressure, as well as external phenomena such as vibrations or shocks.

The arc suppressor is tested for short-circuit currents in the range of 1kArms to 21kArms and it will reduce the generated arc energy to less than 5% of the arc energy released during an arcing time of 1 sec.

Since the system is self-contained, an internal arc fault in the tank will have no impact on the surroundings, so there will be no cleaning work required. No arc fault tests have to be repeated in combination with channel release systems or transformer stations.

### Arc protection in IED (Intelligent Electronic Device)

Protection relays REF615 and REF620 IED can optionally be fitted with a fast and selective arc flash protection. It offers a two- or three-channel arc-fault protection system for arc flash super-vision of different cable compartments of switchgear modules. Total tripping time is less than 100 ms.

## 6.3 Interlocking and locking

### Interlocks

The safety mechanical interlocks between switches are standard, and detailed information is described for each module. They are set out by the IEC standards and are necessary to guarantee the correct operation sequence.

ABB safety interlocks enable the highest level of reliability, even in the case of an accidental error, and ensure operator safety.

### Keys

The use of key interlocks is very important in realizing the interlocking logics between panels of the same switchgear, or of other medium, low and high voltage switchgear. The logics are realized by means of distributors or by ringing the keys. The earthing switch closing and opening operations can be locked by means of keys. For more detailed description, see dedicated interlocking pages for each module and chapter 28 "Key interlocks".

### Padlocks

The cable compartment doors can be locked in the closed position by means of padlocks. The padlock can also be applied to the switches to avoid improper operation of the switchgear. For more detailed description, see dedicated interlocking pages for each module. Padlocks from 4 to 8 mm diameter can be accommodated.

### Blocking coil/electrical interlocking

The earthing switch closing/opening operations can be electrically interlocked by use of electrical blocking coils. For more detailed description, see dedicated interlocking pages for each module.

### Undervoltage release

This release opens the circuit-breaker when there is a sharp reduction or cut in the power supply voltage. This is an optional feature. Voltage presence system with signalling contact is required.

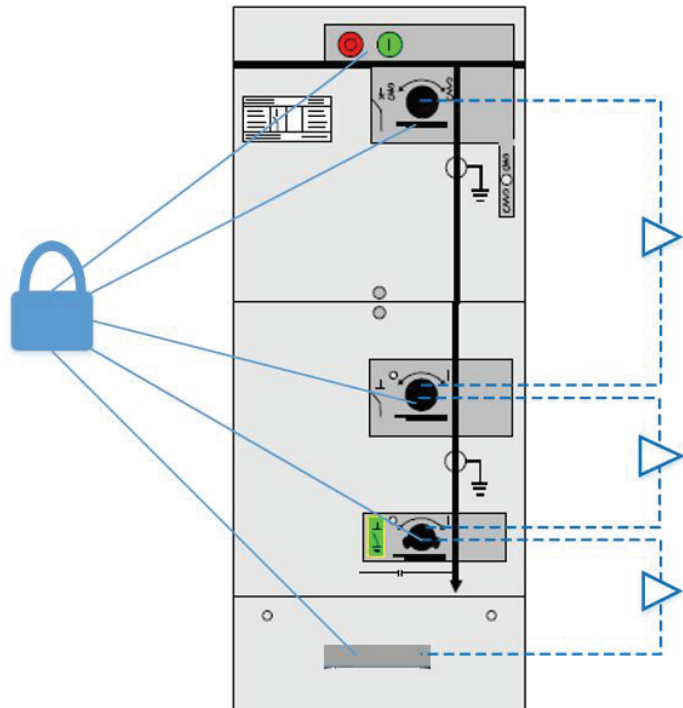



# 7 Applications SafeRing/SafePlus

## SafeRing installed in Compact Secondary Substations

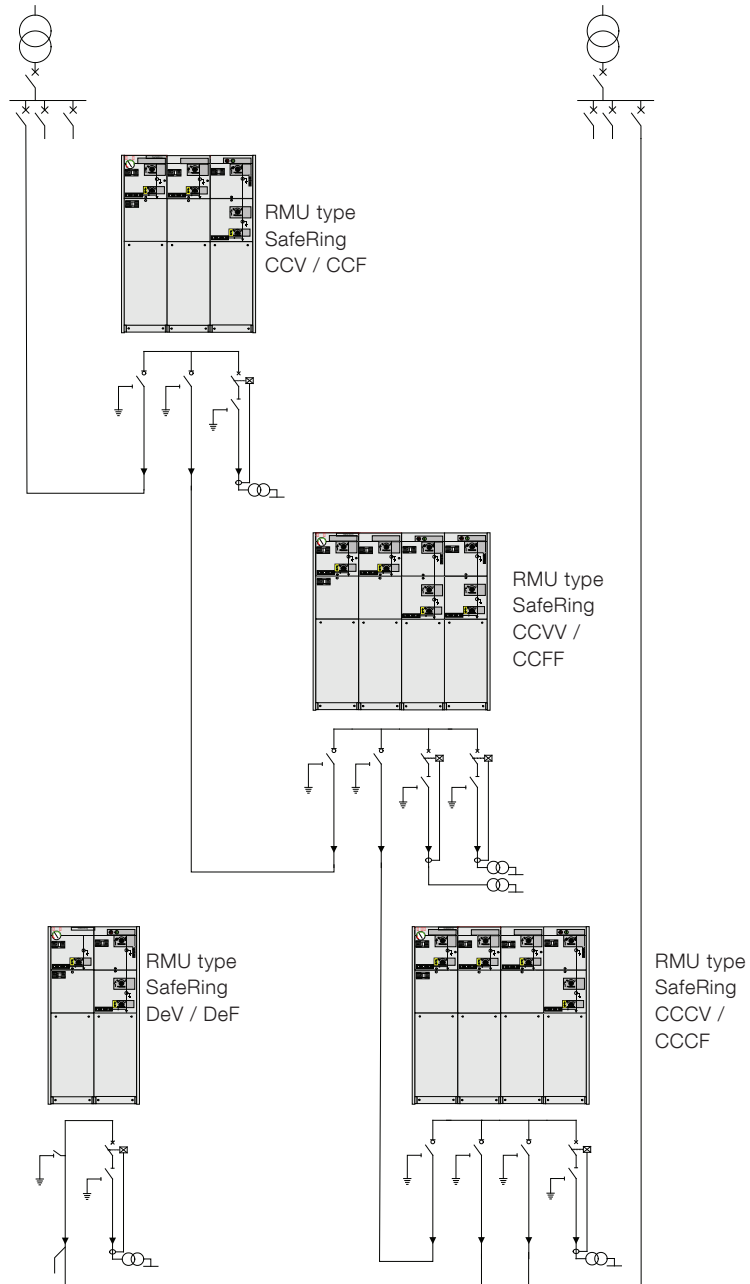

### Applications:

- Compact secondary substations
- Small industries
- Wind power plants
- Hotels, shopping centers, office buildings, business centers etc.
- Light mining applications, airports, hospitals, tunnels and underground railways

### Design range:

- C Cable Switch
- De Direct Cable Connection with Earthing Switch
- F Switch Fuse-Disconnecter
- V Vacuum Circuit-Breaker

## 8 Applications SafeRing

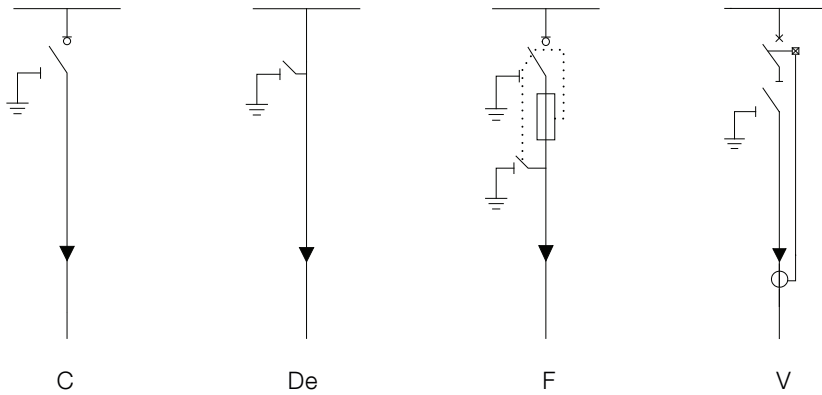

SafeRing is designed for use in the following applications:

- Compact secondary substations
- Small industries
- Wind power plants
- Hotels, shopping centers, office buildings, business centers etc.
- Light mining applications, airports, hospitals, tunnels and underground railways

Available modules:

- C Cable switch
- De Direct cable connection with earthing switch
- F Switch-fuse disconnect
- V Vacuum circuit-breaker

## 8.1 SafeRing configurations



### General

SafeRing is a ring main unit for the secondary distribution network. SafeRing can be supplied in 10 different configurations suitable for most switching applications in 12/24 kV distribution networks. As an option, SafeRing can be delivered as an extendable ring main unit.

SafePlus is ABB's flexible, extendable compact switchgear. Together, SafeRing and SafePlus represent a complete solution for 12/24 kV secondary distribution networks. SafeRing and SafePlus have identical user interfaces.

SafeRing is a completely sealed system with a stainless steel tank containing all the live parts and switching functions. A sealed steel tank with constant atmospheric conditions ensures a high level of reliability as well as personnel safety and a virtually maintenance-free system.

The SafeRing concept offers a choice of either a switch fuse combination or circuit breaker with relay for protection of the transformer. SafeRing can be supplied with an integrated remote control and monitoring unit and additional equipment which makes the switchgear more intelligent.

### SafeRing is supplied with the following standard equipment

- Earthing switches
- Operating mechanisms with integral mechanical interlocking
- Operating handle
- Facilities for padlocks on all switching functions
- Bushings for cable connection in front with cable covers
- Lifting lugs for easy handling
- All 3- and 4-way units are designed for the subsequent fitting of an integrated remote control and monitoring unit
- Cable compartment cover allowing surge arrestor or double cable connection
- Busbar, 630A
- Earthing bar
- Capacitive voltage indication

### Optional features

- Bushings for connection of external busbar on top of RMU
- Bushings (inner cone type) for side connection (400A) (C-, F- and De-modules only)
- Bushings for cable testing, incl. earthing device (C- and De- modules only)
- Interlocking of compartment for cable test bushings
- Arc suppressor with signal (1NO) wired to terminals (only on incoming feeders)
- Arc proof and interlocked cable covers
- Signal (1NO) from internal pressure indicator wired to terminals (only one each SF6 tank)
- Latched single spring mechanism for ring cable switch

### Optional features also available as retrofit

- Manometer for SF6 pressure monitoring (temperature compensated)
- Integrated control and monitoring unit (ICMU)
- Integrated battery and charger
- Motor operation
- Trip coil open
- Trip coil open and close
- Aux. switch for load break switch position 2NO + 2NC
- Aux. switch for vacuum circuit breaker position 2NO + 2NC
- Aux. switch for disconnected position 2NO + 2NC
- Aux. switch for earth switch position 2NO + 2NC
- Aux. switch for fuse blown 1NO
- Vacuum circuit breaker tripped signal 1NO
- Arc proof cable compartment
- Extra base frame (h=450 mm or 290 mm)
- Top entry box
- Relays and RTU
- Different key interlocking systems
- External current and voltage sensors (CT) for monitoring
- Fault passage indicators
- Cable compartment cover with inspection window
- Arc proof cable cover with inspection window
- Deep cable cover for double connection
- Cable support bars, non-magnetic or adjustable
- Earthing bar for surge arrestor

# 8.1 SafeRing configurations

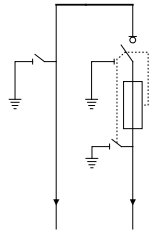
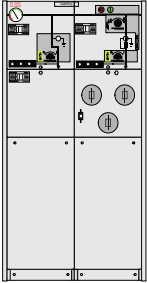

DeF

Depth: 765 mm  
Width: 696 mm  
Height: 1336/1100\* mm

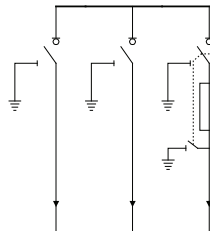
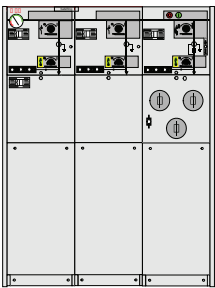

CCF

Depth: 765 mm  
Width: 1021 mm  
Height: 1336/1100\* mm

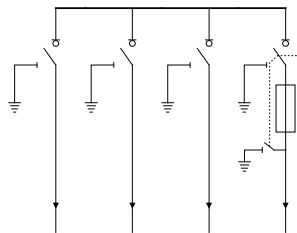
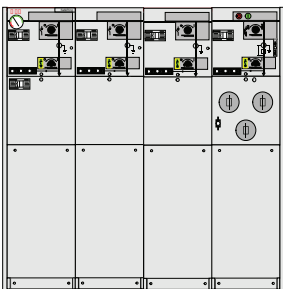

CCCF

Depth: 765 mm  
Width: 1346 mm  
Height: 1336/1100\* mm

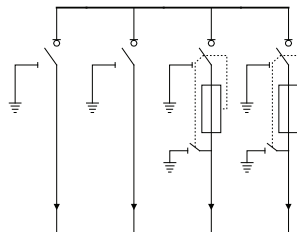
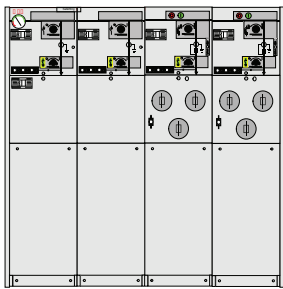

CCFF

Depth: 765 mm  
Width: 1346 mm  
Height: 1336/1100\* mm

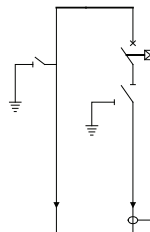
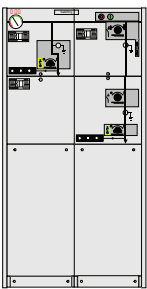

DeV

Depth: 765 mm  
Width: 696 mm  
Height: 1336/1100\* mm

\* 1100 mm version as optional solution

# 8.1 SafeRing configurations

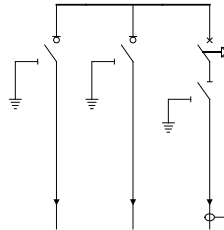
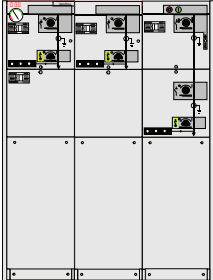

**CCV**  
 Depth: 765 mm  
 Width: 1021 mm  
 Height: 1336/1100\* mm

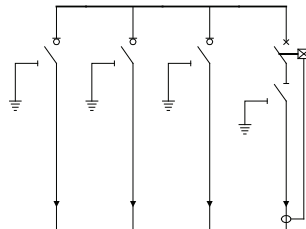
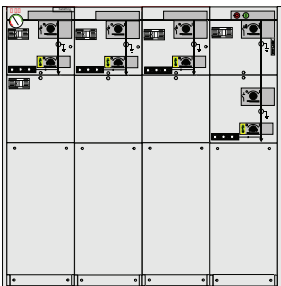

**CCCV**  
 Depth: 765 mm  
 Width: 1346 mm  
 Height: 1336/1100\* mm

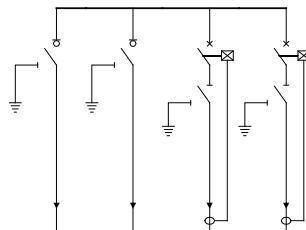
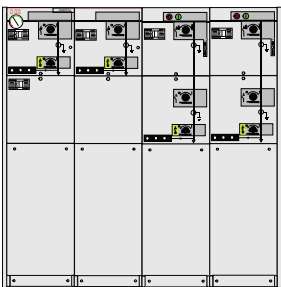

**CCWV**  
 Depth: 765 mm  
 Width: 1346 mm  
 Height: 1336/1100\* mm

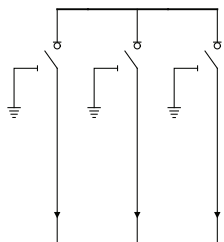
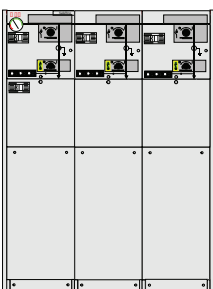

**CCC**  
 Depth: 765 mm  
 Width: 1021 mm  
 Height: 1336/1100\* mm

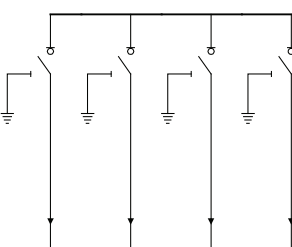
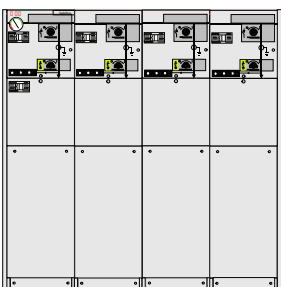

**CCCC**  
 Depth: 765 mm  
 Width: 1346 mm  
 Height: 1336/1100\* mm

\* 1100 mm version as optional solution

## 8.2 Technical data SafeRing

SafeRing		C-module		F-module		V-module	
		Switch disconnecter	Earthing switch	Switch-fuse disconnecter	Downstream earthing switch	Vacuum circuit-breaker	Earthing switch/disconnector
Rated voltage	kV	12/17,5/24	12/17,5/24	12/17,5/24	12/17,5/24	12/17,5/24	12/17,5/24
Rated frequency <sup>5)</sup>	Hz	50/50/50	50/50/50	50/50/50	50/50/50	50/50/50	50/50/50
Power frequency withstand voltage	kV	28 <sup>4)</sup> /38/50	28 <sup>4)</sup> /38/50	28 <sup>4)</sup> /38/50	28 <sup>4)</sup> /38/50	28 <sup>4)</sup> /38/50	28 <sup>4)</sup> /38/50
Lightning impulse withstand voltage	kV	95/95/125	95/95/125	95/95/125	95/95/125	95/95/125	95/95/125
Rated normal current	A	630/630/630		200 <sup>1)</sup>		200/200/200	
Breaking capacities:							
- active load	A	630/630/630					
- closed loop	A	650/650/650					
- off load cable charging	A	140/140/140					
- off load transformer	A			20/20/20			
- earth-fault	A	205/160/160					
- earth-fault cable charging	A	117/91/91					
- short-circuit breaking current	kA			see <sup>2)</sup>		16/16/16	
Making capacity	kA	52,5/40/40	52,5/40/40	see <sup>2)</sup>	12,5/12,5/12,5	40/40/40	40/40/40
Short time current 3 sec. <sup>3)</sup>	kA	21/16/16	21/16/16			16/16/16	16/16/16

<sup>1)</sup> Depending on the current rating of the fuse-link

<sup>2)</sup> Limited by high voltage fuse-links

<sup>3)</sup> Maximum rating for bushings Interface C (400 series bolted)

<sup>4)</sup> GOST version is available with 42kV power frequency withstand voltage

<sup>5)</sup> For rated frequency 60Hz de-rating for current parameters needs to be applied

## 9 SafePlus modules



### General

SafePlus is a metal enclosed compact switchgear system for up to 24 kV distribution applications. The switchgear has a unique flexibility due to its extendability and the possible combination of fully modular and semi-modular configurations.

SafePlus combined with SafeRing, which is ABB's standard ring main unit, represent a complete solution for 12/24 kV distribution networks.

SafePlus and SafeRing have identical user interfaces, operation procedures, spare parts and components.

SafePlus is a completely sealed system with a stainless steel tank containing all live parts and switching functions.

A sealed steel tank with constant gas conditions ensures a high level of reliability as well as personnel safety and a virtually maintenance-free system. As an option, external busbars can be provided to obtain full modularity.

The external busbar kit has to be mounted to the switchgears on site. It is fully insulated and screened to ensure reliability and climatic independence.

The SafePlus system offers a choice of either a switch-fuse combination or a circuit-breaker with relay for protection of the transformer.

SafePlus accommodates a wide selection of protection relays for most applications.

SafePlus can also be supplied with remote control and monitoring equipment.

## 9.1 Applications SafePlus

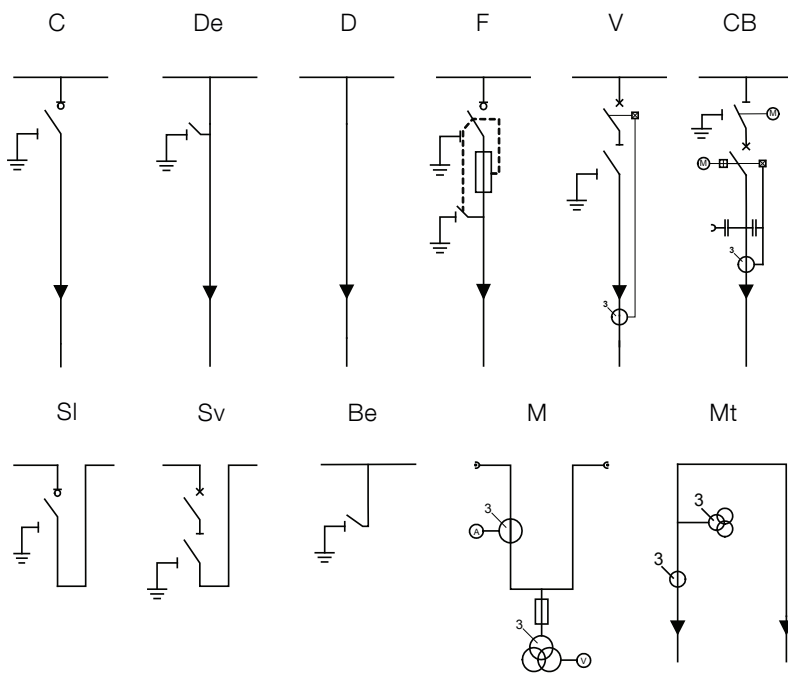

SafePlus is designed for use in the following applications:

- Compact secondary substations
- Small industries
- Wind power plants
- Hotels, shopping centers, office buildings, business centers etc.
- Light mining applications, airports, hospitals, tunnels and underground railways

Available modules:

C	Cable switch module
De	Direct cable connection with earthing module
D	Direct cable connection module
F	Switch-fuse disconnecter module
V	Vacuum circuit-breaker module
Be	Busbar earthing module
SI	Busbar sectionalizer, load break switch module
Sv	Busbar sectionalizer, vacuum circuit-breaker module
CB	Circuit-breaker module
M	Metering module
Mt	Metering tariff module
V20/V25	Vacuum circuit-breaker module 20/25kA
Sv20/Sv25	Busbar sectionalizer, vacuum circuit-breaker 20/25kA module



## 9.2 C - Cable switch module

The cable switch (C-Module) is a three position switch-disconnector and earthing switch using SF<sub>6</sub>-gas as an arc quenching medium.

The switch positions are close – open – earthed. In the open position the switch satisfies the disconnector requirements.

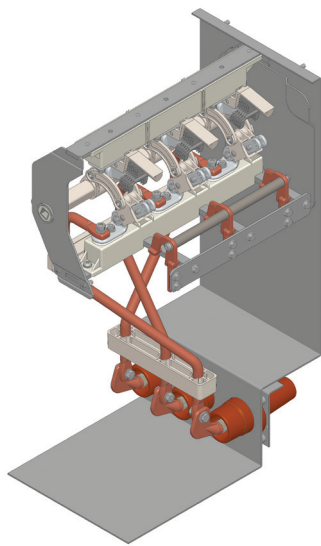

## 9.2.1 C - Cable switch module - Technical data

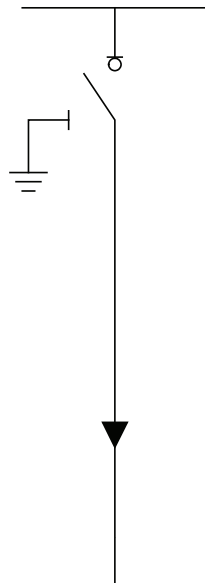
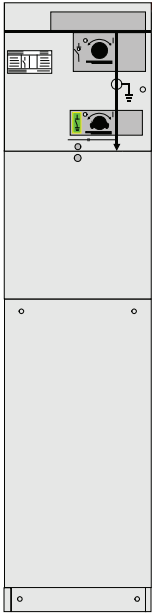

Depth: 765 mm  
 Width: 325 mm  
 Height: 1336 mm / optional 1100 mm

### Common features

All modules share many common features. These are described in the chapter "SafeRing/SafePlus configurations".

### Standard features

- Three position load break switch with disconnect and earthing switch
- Operating mechanism with two separate operating shafts for load break function and earthing function
- Switch position indication for load break switch and earthing switch
- Cable bushings horizontal in front, Interface C (400 series bolted) with integrated voltage divider for voltage indication

### Technical data

#### Switch disconnect

Rated voltage	kV	12	17,5	24
Power frequency withstand voltage	kV	28 <sup>1)</sup>	38	50
Impulse withstand voltage	kV	95	95	125
Rated normal current	A	630	630	630
Breaking capacities:				
- active load	A	630	630	630
- closed loop	A	650	650	650
- off load cable charging	A	140	140	140
- earth-fault	A	205	160	160
- earth-fault cable charging	A	117	91	91
Making capacity	kA	62,5	52,5	52,5
Short time current 3 sec.	kA	25	21	21
Number of mechanical operations	1000 close / open manual			
Electrical and mechanical classes	E3, C2, M1			

#### Earthing switch

Rated voltage	kV	12	17,5	24
Power frequency withstand voltage	kV	28 <sup>1)</sup>	38	50
Impulse withstand voltage	kV	95	95	125
Making capacity	kA	62,5	50	50
Short time current 3 sec.	kA	25	21	21
Number of mechanical operations	1000 close / open manual			
Electrical and mechanical classes	E2, M1			

<sup>1)</sup> GOST version is available with 42kV power frequency withstand voltage

### Optional features

- Bushings for side extension (400 A)
- Bushings for cable testing (incl. earthing device test points)
- Cable bushings:
  - Interface B (400 series plug-in, I<sub>n</sub> = 400 A)
  - Interface C (400 series bolted) combisensors with integrated capacitor for voltage indication and sensors for current and voltage monitoring
  - Interface D (600 series bolted)
- Arc suppressor with signal (1NO) wired to terminals (only on incoming feeder)
- Signal (1NO) from internal pressure indicator wired to terminals (only one each SF<sub>6</sub> tank)
- Latched single spring mechanism

### Optional features also available as retrofit



- Motor operation for load break switch
- Low voltage compartment / top entry box

## 9.2.2 C - Cable switch module - Interlocking

### Abbreviations

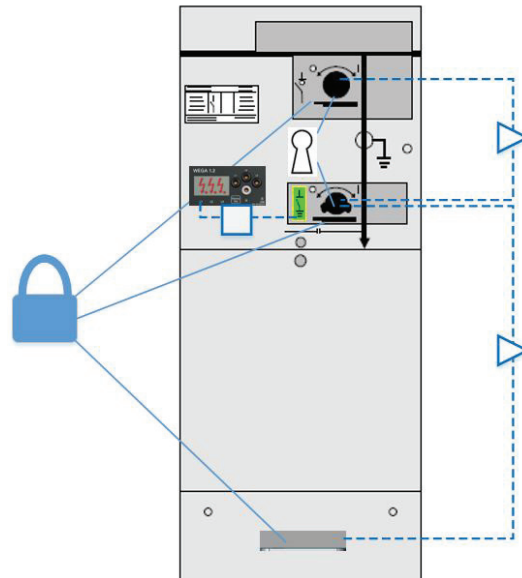
LBS	Load break switch
ES	Earthing switch
CB	Circuit breaker
SD	Switch-disconnector
SF	Switch-fuse

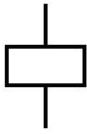

Interlock type	Operation	Condition	Comment
Mechanical interlock C-module 	Closing LBS	ES is open, cable compartment cover is on	Cable compartment interlock is optional
	Opening LBS	ES is open	Standard
	Closing ES	LBS is open	Standard
	Opening ES	LBS is open	Standard
	Opening cable compartment	ES is closed	Optional feature
	Open cable test door	ES is closed	Optional feature (see chapter 21)
Electrical interlock C-module 	Remote operation of LBS	Gas pressure in tank is under treshold	Optional feature. Manometer with signalling contact, contact can be used only for signalling purposes
	Closing ES	Incoming cable is without voltage	Optional feature. Voltage presence System with signalling contact is required.
Padlocks C-module Padlocks to be provided by customer 	Lock on LBS	None	Standard feature (Diameter of padlock: 4 -8 mm)
	Lock on ES	None	Standard feature (Diameter of padlock: 4 -8 mm)
	Lock cable compartment cover in closed position	None	Optional feature (Diameter of padlock: 4 -8 mm)
	Lock cable compartment cover in open position	None	Optional feature (Diameter of padlock: 4 -8 mm)
	Lock on local push buttons	None	Optional feature (Diameter of padlock: 4 -8 mm)
Key interlock C-module 	Key lock on LBS	See details in chapter 28 "Key interlocks"	Optional feature
	Key lock on ES	See details in chapter 28 "Key interlocks"	Optional feature

## 9.3 F - Switch-fuse module

The switch-fuse (F-module) is a three position switch disconnector and earthing switch identical to the cable switch (C-module).

By means of the fuse tripping device it operates as a switch-fuse combination. There is a double earthing switch which in earthed position connects earth to both sides of the fuse-links simultaneously.

Both earthing switches are operated in one operation. The switch-fuse and earthing switch is mechanically interlocked to prevent hazardous access to the fuse-links.

The lower cover which gives access to the fuse-links is also mechanically interlocked with the earthing switch.

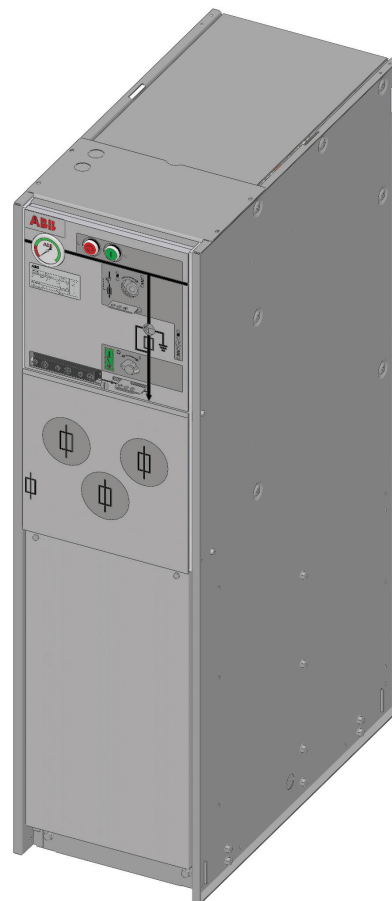
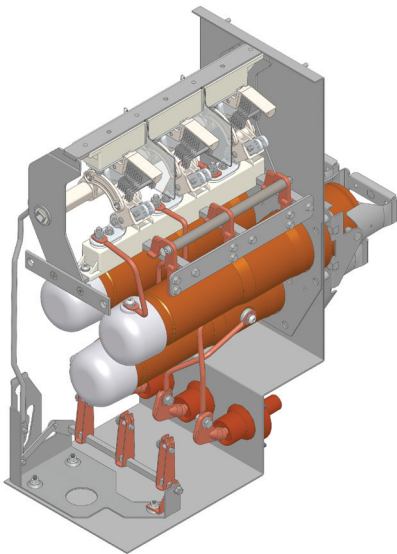

## 9.3.1 F - Switch-fuse module - Technical data

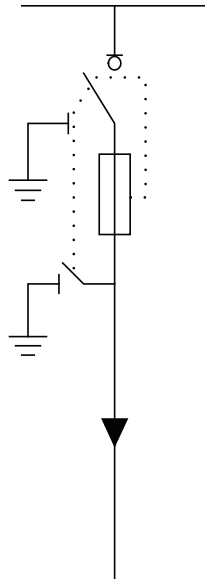
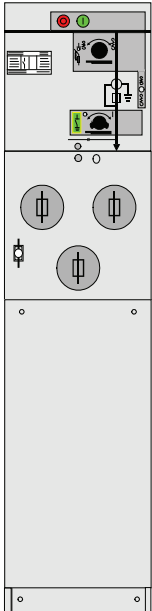

Depth: 765 mm  
 Width: 325 mm  
 Height: 1336 mm / optional 1100 mm

### Common features

All modules share many common features. These are described in the chapter "SafeRing/SafePlus configurations".

### Standard features

- Three position switch-fuse-disconnector with upstream earthing switch mechanically linked with downstream earthing switch
- Switch position indication for switch-fuse-disconnector and earthing switches
- Operating mechanism with double spring for switch-fuse-disconnector function
- Common mechanism for earthing functions
- Fuse canisters for DIN type fuse. Only accessible when earthing switches are closed
- Fuse-link / transformer rating:  
 12 kV, max 125 A CEF fuses  
 24 kV, max 63 A CEF fuses
- Fuse tripping arrangement
- Optical fuse trip indication

### Technical data

#### Switch-fuse-disconnector

Rated voltage	kV	12	17,5	24
Power frequency withstand voltage	kV	28 <sup>2)</sup>	38	50
Impulse withstand voltage	kV	95	95	125
Rated normal current	A	200	200	200
Breaking capacities:				
- off load transformer	A	20	20	20
Making capacity	kA	<sup>1)</sup>	<sup>1)</sup>	<sup>1)</sup>
Number of mechanical operations	1000 close / open manual			
Electrical and mechanical classes	E3, M1			

#### Earthing switch downstream

Rated voltage	kV	12	17,5	24
Power frequency withstand voltage	kV	28 <sup>2)</sup>	38	50
Impulse withstand voltage	kV	95	95	125
Making capacity	kA	12,5	12,5	12,5
Short time current 1 sec.	kA	5	5	5
Number of mechanical operations	1000 close / open manual			
Electrical and mechanical classes	E2, M1			

<sup>1)</sup> Limited by high voltage fuse-links

<sup>2)</sup> GOST version is available with 42kV power frequency withstand voltage

For fuse selection tables and transformer protection, see chapter 23, "Fuses".

### Optional features

- Bushings for side extension (400 A)
- Cable bushings:  
 Interface B (400 series plug-in, I<sub>n</sub> = 400A)  
 Interface C (400 series bolted)  
 Interface C (400 series bolted) combisensors with integrated screen for voltage indication and sensors for current and voltage monitoring
- Signal (1NO) from internal pressure indicator wired to terminals (only one each SF<sub>6</sub> tank)

### Optional features also available as retrofit



- Motor operation for switch-fuse-disconnector
- Auxiliary switches for load break switch position, earthing switch position and fuse blown
- Trip coil open
- Trip coil open and close

## 9.3.2 F - Switch-fuse module - Interlocking

### Abbreviations

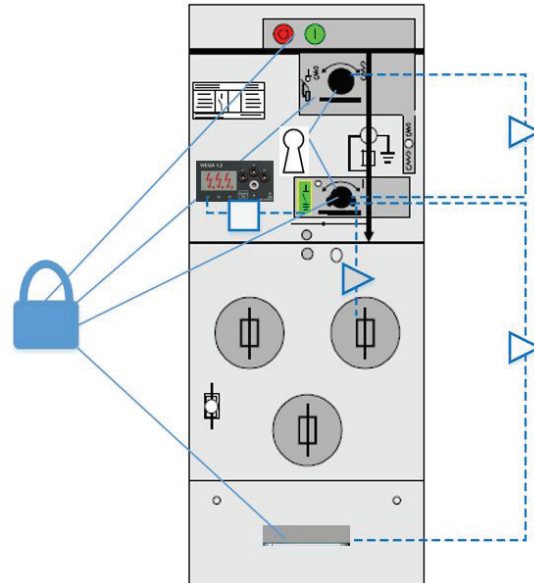
LBS	Load break switch
ES	Earthing switch
CB	Circuit breaker
SD	Switch-disconnector
SF	Switch-fuse

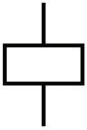

Interlock type	Operation	Condition	Comment
Mechanical interlock F-module  	Closing SF	ES is open, fuse striker pin has not triggered, cable compartment cover is on	Cable compartment interlock is optional
	Opening SF	ES is open	Standard
	Closing ES	SF is open, fuse door panel is closed	Standard
	Opening ES	SF is open, fuse door panel is closed	Standard
	Opening fuse door panel	ES is closed	Standard
	Closing fuse door panel	ES is closed	Standard
	Opening cable compartment	ES is closed	Optional feature
	Closing cable compartment	ES is closed	Optional feature
Electrical interlock F-module  	Closing ES	Incoming cable is without voltage	Optional feature. Voltage presence System with signalling contact is required.
Padlocks F-module Padlocks to be provided by customer  	Lock on SF	None	Standard feature (Diameter of padlock: 4 -8 mm)
	Lock on ES	None	Standard feature (Diameter of padlock: 4 -8 mm)
	Lock cable compartment cover in closed position	None	Optional feature (Diameter of padlock: 4 -8 mm)
	Lock cable compartment cover in open position	None	Optional feature (Diameter of padlock: 4 -8 mm)
	Lock on push buttons	None	Optional feature (Diameter of padlock: 4 -8 mm)
Key interlock F-module  	Lock on SF		
	Key lock on ES	See details in chapter 28 "Key interlocks"	Optional feature

## 9.4 V - Vacuum circuit-breaker module

The vacuum circuit-breaker (V-Module) has vacuum bottles as interrupters of the current.

A three-position disconnect/earthing switch is connected in series with the circuit-breaker main circuit.

The operation between vacuum circuit-breaker and disconnect/earthing switch is mechanically interlocked.

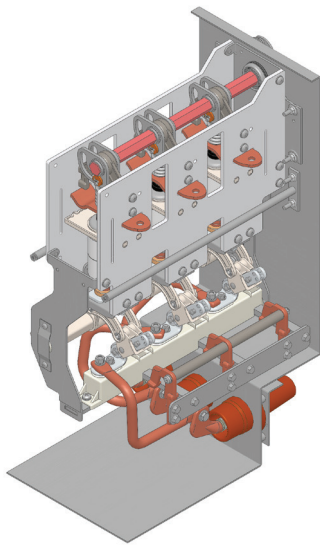

## 9.4.1 V - Vacuum circuit-breaker module - Technical data

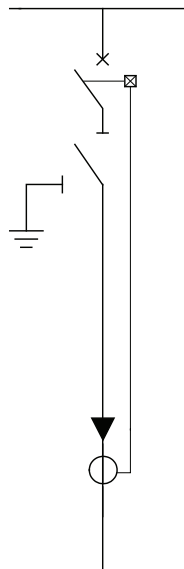
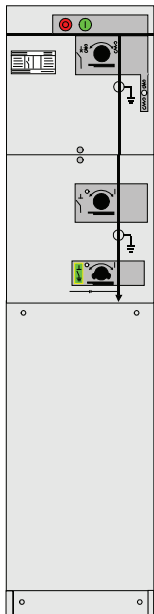

Depth: 765 mm  
 Width: 325 mm  
 Height: 1336 mm / optional 1100 mm

– blocking coil

### Common features

All modules share many common features. These are described in the chapter “SafeRing/SafePlus configurations”.

### Standard features

- 200 A vacuum circuit-breaker for transformer protection or 630 A vacuum circuit-breaker for feeder protection
- Two position double spring mechanism for vacuum circuit-breaker
- Three position disconnector/earthing switch downstream vacuum circuit-breaker
- Three positioning single spring mechanism for disconnector/earthing switch
- Interlocking between vacuum circuit-breaker and disconnector/earthing switch
- Switch positioning indication for vacuum circuit-breaker and disconnector/earthing switch
- Self-powered electronic protection relay with ring core CTs on cables (only standard on 200 A)
- Trip coil (for relay tripping)
- Cable bushings horizontally in front; Interface A (200 series plug-in) for 200 A vacuum circuit-breaker with integrated capacitor for voltage indication and Interface C (400 series bolted) for 630 A vacuum circuit-breaker with integrated capacitor for voltage indication

### Technical data

#### Vacuum circuit-breaker

Rated voltage	kV	12	17,5	24
Power frequency withstand voltage	kV	28 <sup>1)</sup>	38	50
Impulse withstand voltage	kV	95	95	125
Rated normal current	A	200 / 630 <sup>2)</sup>		
Breaking capacities:				
- short-circuit breaking current	kA	21	16	16
Making capacity	kA	52,5	40	40
Short time current 3 sec. <sup>3)</sup>	kA	21	16	16
Number of mechanical operations	2000 close / open manual			
Electrical and mechanical classes	E2, C2, S1, M1			
Operation sequence	O - 3min - CO - 3min - CO			

#### Earthing switch downstream

Rated voltage	kV	12	17,5	24
Power frequency withstand voltage	kV	28 <sup>1)</sup>	38	50
Impulse withstand voltage	kV	95	95	125
Making capacity	kA	52,5	40	40
Short time current 3 sec.	kA	21	16	16
Number of mechanical operations	1000 close / open manual			
Electrical and mechanical classes	E2, M1			

<sup>1)</sup> GOST version is available with 42kV power frequency withstand voltage

<sup>2)</sup> Depend on type of used bushing

<sup>3)</sup> Interface A - 12,5kA/1s, interface B - 16kA/1s

### Optional features

- Cable bushings:
  - Interface B (400 series plug-in)
  - Interface D (600 series bolted)
  - Interface C (400 series bolted) combisensors with integrated voltage divider for voltage indication and integrated sensor for current and voltage monitoring
- Arc suppressor with signal (1NO) wired to terminals
- Signal (1NO) from internal pressure indicator wired to terminals (only one each SF<sub>6</sub> tank)

### Optional features also available as retrofit

- Motor operation for vacuum circuit-breaker
- Auxiliary switches; Vacuum circuit breaker position 2NO+2NC, disconnector position 2NO+2NC, earthing switch position 2NO+2NC and vacuum circuit-breaker tripped signal 1NO
- Blocking coil
- Undervoltage release with/without time delay





## 9.4.2 V - Vacuum circuit-breaker module - Interlocking

### Abbreviations

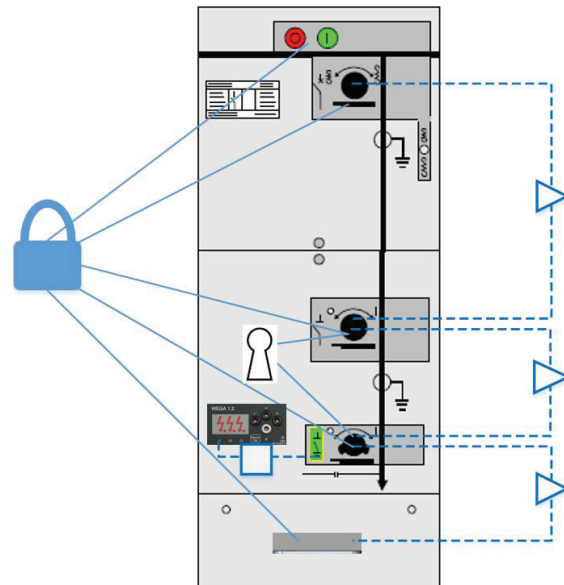
LBS	Load break switch
ES	Earthing switch
CB	Circuit breaker
SD	Switch-disconnector
SF	Switch-fuse

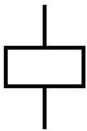

Interlock type	Operation	Condition	Comment
Mechanical interlock V-module  	Closing CB	None	
	Opening CB	None	
	Closing SD	CB is open, ES is open, cable compartment cover is on	Cable compartment interlock is optional
	Opening SD	CB is open, ES is open	Standard
	Closing ES	SD is open	Standard
	Opening ES	SD is open	Standard
	Opening cable compartment	ES is closed	Optional feature
	Closing cable compartment	ES is closed	Optional feature
Electrical interlock V-module  	Closing ES	Incoming cable is without voltage	Optional feature. Voltage presence System with signalling contact is required.
Padlocks V-module Padlocks to be provided by customer  	Lock on ES	None	Standard feature (Diameter of padlock: 4 -8 mm)
	Lock on CB	None	Standard feature (Diameter of padlock: 4 -8 mm)
	Lock on SD	None	Standard feature (Diameter of padlock: 4 -8 mm)
	Lock on push buttons	None	Optional feature (Diameter of padlock: 4 -8 mm)
	Lock cable compartment cover in closed position		Optional feature (Diameter of padlock: 4 -8 mm)
	Lock cable compartment cover in open position	None	Optional feature (Diameter of padlock: 4 -8 mm)
Key interlock V-module  	Key lock on SD	See details in chapter 28 "Key interlocks"	Optional feature
	Key lock on ES	See details in chapter 28 "Key interlocks"	Optional feature

## 9.5 V - Vacuum circuit-breaker - V25 / V20

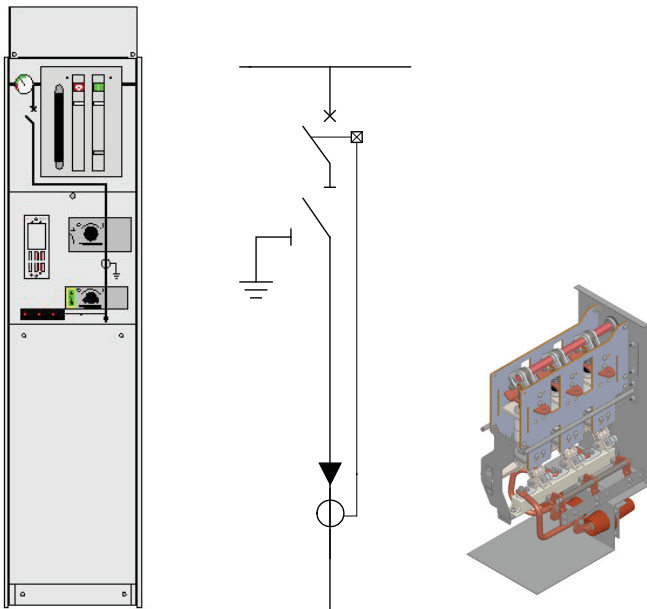

Depth: 765 mm  
 Width: 325 mm  
 Height: 1460 mm / optional 1226 mm

### Common features

All modules share many common features. These are described in the chapter "SafeRing/SafePlus configurations".

### Standard features

- 630 A vacuum circuit-breaker for feeder protection
- Mechanism with operating sequence;  
O - 0,3 s - CO - 3 min - CO
- Auto-reclosing capability
- Vacuum circuit-breaker with downstream three-position disconnecter/earthing switch
- Three-position single spring mechanism for disconnecter/earthing switch
- Interlocking between vacuum circuit-breaker and disconnecter/earthing switch
- Switch position indication for vacuum circuit-breaker and disconnecter/earthing switch
- Mechanical counter
- Cable bushings horizontally in front Interface C (400 series bolted) with integrated capacitor for voltage indication
- Cable compartment cover allowing surge arrester or double cable connection

### Technical data

#### Vacuum circuit-breaker

Rated voltage	kV	12	24
Power frequency withstand voltage	kV	28 <sup>1)</sup>	50
Impulse withstand voltage	kV	95	125
Rated normal current	A	630	630
Breaking capacities:			
- short-circuit breaking current	kA	25	20
Making capacity	kA	65	50
Short time current 3 sec.	kA	25	21
Number of mechanical operations	2000 close / open manual		
Electrical and mechanical classes (12kV):			
E2,C1,S1,M1 for operating sequence O - 3min - CO - 3min - CO			
E1,C1,S1,M1 for operating sequence O - 0,3s - CO - 3min - CO			
Electrical and mechanical classes (24kV):			
E2,C2,S1,M1 for operating sequence O - 3min - CO - 3min - CO			
E1,C2,S1,M1 for operating sequence O - 0,3s - CO - 3min - CO			

#### Earthing switch downstream

Rated voltage	kV	12	24
Power frequency withstand voltage	kV	28	50
Impulse withstand voltage	kV	95	125
Making capacity	kA	62,5	50
Short time current 1 sec.	kA	25	21
Short time current 3 sec.	kA	21 <sup>2)</sup>	21
Number of mechanical operations	1000 close / open manual		
Electrical and mechanical classes	E2, M1		

<sup>1)</sup> GOST version is available with 42kV power frequency withstand voltage

<sup>2)</sup> 25kA available as option

### Optional features as factory mounted

- Cable bushings:
  - Interface C (400 series bolted) combisensors with integrated voltage divider for voltage indication and integrated sensor for current and voltage monitoring
- Arc proof cable cover (IAC AFL 16/20 kA 1 sec.)
- Arc suppressor with signal (1NO) wired to terminals

### Optional features also available as retrofit

- Motor operation for vacuum circuit-breaker
- Auxiliary switches: Vacuum circuit breaker position 2NO+2NC, disconnecter position 2NO+2NC, earthing switch position 2NO+2NC
- Undervoltage release with/without time delay
- Blocking magnet to prevent unintended operation
- Advanced relays type REF, REX and others

### Interlocking

Rules are same as for standard V-module, except for lockable push buttons.

## 9.6 SI - Busbar sectionalizer module

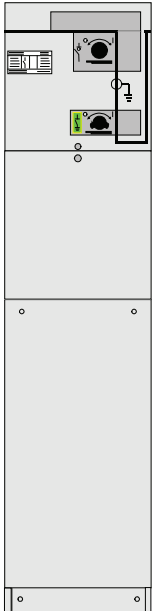

Depth: 765 mm  
 Width: 325 mm  
 Height: 1336 mm /  
 optional 1100 mm

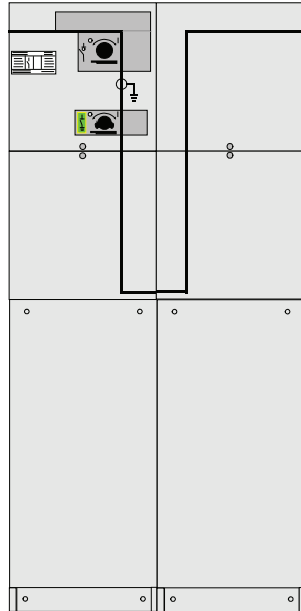

Depth: 765 mm  
 Width: 650 mm  
 Height: 1336 mm /  
 optional 1100 mm

Extension is needed when  
 SI-module is the last module  
 in one common SF<sub>6</sub>-tank

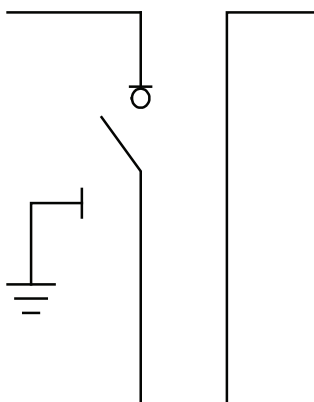

### Technical data

#### Busbar sectionalizer SI

Rated voltage	kV	12	17,5	24
Power frequency withstand voltage	kV	28 <sup>1)</sup>	38	50
Impulse withstand voltage	kV	95	95	125
Rated normal current	A	630	630	630
Breaking capacities:				
- active load	A	630	630	630
- closed loop	A	670	670	670
- off load cable charging	A	141	141	141
- earth-fault	A	205	160	160
- earth-fault cable charging	A	117	91	91
Making capacity	kA	62,5	52,5	52,5
Short time current 3 sec.	kA	25	21	21
Number of mechanical operations	1000 close / open manual			
Electrical and mechanical classes	E3, C2, M1			

#### Earthing switch

Rated voltage	kV	12	17,5	24
Power frequency withstand voltage	kV	28 <sup>1)</sup>	38	50
Impulse withstand voltage	kV	95	95	125
Rated normal current	A	630	630	630
Making capacity	kA	62,5	50	50
Short time current 3 sec.	kA	21	21	21
Number of mechanical operations	1000 close / open manual			
Electrical and mechanical classes	E2, M1			

<sup>1)</sup> GOST version is available with 42kV power frequency withstand voltage

### Common features

All modules share many common features. These are described in the chapter "SafeRing/SafePlus configurations".

### Standard features

- Three positioning load break switch with disconnecter and earthing switch
- Operating mechanism with two separate operating shafts for load break function and earthing function
- Switch position indication for load break switch and earthing switch

### Optional features

- Latched single spring mechanism

### Optional features also available as retrofit

- Motor operation for load break switch
- Auxiliary switches, load break switch position 2NO+2NC and earthing switch position 2NO+2NC
- Ronis key interlock

### Interlocking

Rules are same as for the C-module with the exception of the rules for the cable compartment cover.

## 9.7 Sv - Busbar sectionalizer module

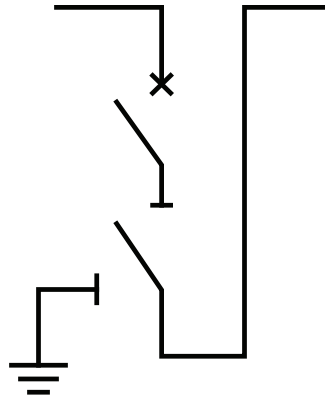
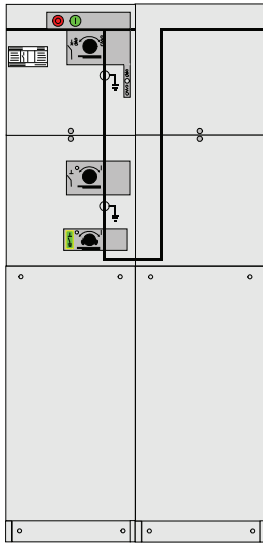

Depth: 765 mm  
 Width: 650 mm  
 Height: 1336 mm /  
 optional 1100 mm

Sv is always in combination  
 with busrise module (Br)

### Common features

All modules share many common features. These are described in the chapter "SafeRing/SafePlus configurations".

### Standard features

- 630 A vacuum circuit-breaker
- Two position double spring mechanism for vacuum circuit-breaker
- Three position disconnector / earthing switch downstream vacuum circuit-breaker
- Three position single spring mechanism for disconnector / earthing switch
- Interlocking between vacuum circuit-breaker and disconnector / earthing switch
- Switch position indication for vacuum circuit-breaker and disconnector / earthing switch

### Technical data

#### Busbar sectionalizer Sv

Rated voltage	kV	12	17,5	24
Power frequency withstand voltage	kV	28 <sup>1)</sup>	38	50
Impulse withstand voltage	kV	95	95	125
Rated normal current	A	630	630	630
Breaking capacities:				
- short-circuit breaking current	kA	21	16	16
Making capacity	kA	52,5	40	40
Short time current 3 sec.	kA	21	16	16
Number of mechanical operations	2000 close / open manual			
Electrical and mechanical classes	E2, C2, S1, M1			
Operation sequence	O - 3min - CO - 3min - CO			

#### Earthing switch

Rated voltage	kV	12	17,5	24
Power frequency withstand voltage	kV	28 <sup>1)</sup>	38	50
Impulse withstand voltage	kV	95	95	125
Making capacity	kA	52,5	40	40
Short time current 3 sec.	kA	21	16	16
Number of mechanical operations	1000 close / open manual			
Electrical and mechanical classes	E2, M1			

<sup>1)</sup> GOST version is available with 42kV power frequency withstand voltage

### Optional features also available as retrofit

- Motor operation for vacuum circuit-breaker
- Auxiliary switches, vacuum circuit-breaker position 2NO+2NC, disconnector position 2NO+2NC and earthing switch position 2NO+2NC
- Protection relay (metering module is required)
- Trip coil for relay trip
- Additional trip coil
- Undervoltage release with/without time delay

### Interlocking

Rules are same as for the standard V-module with the exception of the rules for the cable compartment cover.

## 9.8 Sv - Busbar sectionalizer module - Sv25 / Sv20

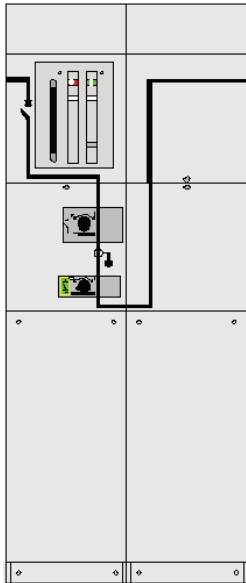

Depth: 765 mm  
 Width: 650 mm  
 Height: 1460 mm /  
 optional 1226 mm

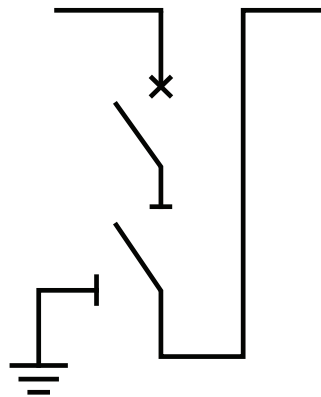

Sv is always in combination  
 with busrise module (Br)

### Technical data

#### Vacuum circuit-breaker

Rated voltage	kV	12	24
Power frequency withstand voltage	kV	28 <sup>1)</sup>	50
Impulse withstand voltage	kV	95	125
Rated normal current	A	630	630
Breaking capacities:			
- short-circuit breaking current	kA	25	20
Making capacity	kA	65	50
Short time current 3 sec.	kA	25	21
Number of mechanical operations	2000 close / open manual		

#### Electrical and mechanical classes (12kV):

E2,C1,S1,M1 for operating sequence O - 3min - CO - 3min - CO

E1,E2,C1,S1,M1 for operating sequence O - 0,3s - CO - 3min - CO

#### Electrical and mechanical classes (24kV):

E2,C2,S1,M1 for operating sequence O - 3min - CO - 3min - CO

E1,C2,S1,M1 for operating sequence O - 0,3s - CO - 3min - CO

#### Earthing switch downstream

Rated voltage	kV	12	24
Power frequency withstand voltage	kV	28 <sup>1)</sup>	50
Impulse withstand voltage	kV	95	125
Making capacity	kA	62,5	50
Short time current 1 sec.	kA	25	21
Short time current 3 sec.	kA	21 <sup>2)</sup>	21
Number of mechanical operations	1000 close / open manual		
Electrical and mechanical classes	E2, M1		

<sup>1)</sup> GOST version is available with 42kV power frequency withstand voltage

<sup>2)</sup> 25kA available as option

### Common features

All modules share many common features. These are described in the chapter "SafeRing/SafePlus configurations".

### Standard features

- 630 A vacuum circuit-breaker
- Mechanism with operating sequence;  
O - 0,3 s - CO - 3 min - CO
- Vacuum circuit-breaker with downstream three-position disconnecter/earthing switch
- Three position single spring mechanism for disconnecter / earthing switch
- Interlocking between vacuum circuit-breaker and disconnecter / earthing switch
- Switch position indication for vacuum circuit-breaker and disconnecter / earthing switch

### Optional features also available as retrofit

- Motor operation for vacuum circuit-breaker
- Low voltage compartment / Top entry box
- Auxiliary switches, vacuum circuit-breaker position  
2NO+2NC, disconnecter position 2NO+2NC and earthing switch position 2NO+2NC
- Protection relay (metering module is required)
- Trip coil for relay trip
- Additional trip coil
- Undervoltage release with/without time delay

### Interlocking

Rules are same as for the standard V-module with the exception of the rules for the cable compartment cover.

## 9.9 D - Direct cable connection module

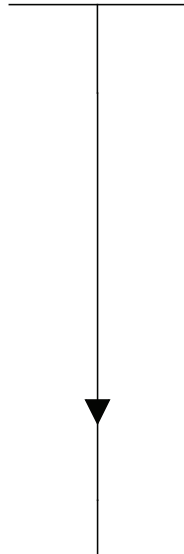
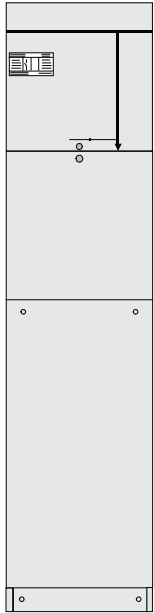

Depth: 765 mm  
 Width: 325 mm  
 Height: 1336 mm / optional 1100 mm

### Technical data

#### Direct cable connection

Rated voltage	kV	12	17,5	24
Power frequency withstand voltage	kV	28 <sup>1)</sup>	38	50
Impulse withstand voltage	kV	95	95	125
Rated normal current	A	630	630	630
Short time current 3 sec.	kA	25	21	21

<sup>1)</sup> GOST version is available with 42kV power frequency withstand voltage

### Common features

All modules share many common features. These are described in the chapter "SafeRing/SafePlus configurations".

### Optional features

- Bushings for connection of external busbars
- Cable bushings:
  - Interface B (400 series plug-in) (In = 400 A)
  - Interface C (400 series bolted) combisensors with integrated capacitor for voltage indication and sensors for current and voltage monitoring
  - Interface D (600 series bolted)

### Interlocking

Padlock on cable compartment cover (optional).

## 9.10.1 De - Direct cable connection module with earthing switch - Technical data

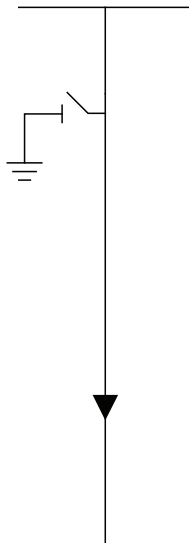
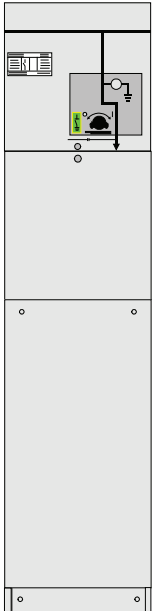

Depth: 765 mm  
 Width: 325 mm  
 Height: 1336 mm / optional 1100 mm

### Technical data

#### Direct cable connection with earthing switch

Rated voltage	kV	12	17,5	24
Power frequency withstand voltage	kV	28 <sup>1)</sup>	38	50
Impulse withstand voltage	kV	95	95	125
Rated normal current	A	630	630	630
Making capacity	kA	62,5	50	50
Short time current 3 sec.	kA	25	21	21
Number of mechanical operations	1000 close / open manual			

<sup>1)</sup> GOST version is available with 42kV power frequency withstand voltage

### Common features

All modules share many common features. These are described in the chapter "SafeRing/SafePlus configurations".

### Standard features

- Earthing switch
- Two position single spring mechanism
- Switch position indication
- Cable bushings horizontal in front, Interface C (400 series bolted) with integrated capacitor for voltage indication

### Optional features

- Bushings for cable testing, incl. earthing device
- Cable bushings:
  - Interface B (400 series plug-in) (I<sub>n</sub> = 400 A)
  - Interface C (400 series bolted) combisensors with integrated capacitor for voltage indication and sensors for current and voltage monitoring
  - Interface D (600 series bolted)
- Interlocking of compartment for cable test bushings

## 9.10.2 De-module - Interlocking

### Abbreviations

LBS	Load break switch
ES	Earthing switch
CB	Circuit breaker
SD	Switch-disconnector
SF	Switch-fuse

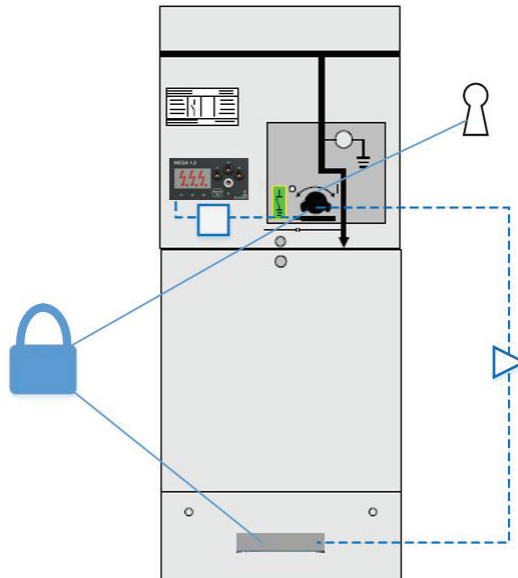

Interlock type	Operation	Condition	Comment
Mechanical interlock De-module 	Closing ES	None	
	Opening ES	None	
	Opening cable compartment	ES is closed	Optional feature
	Closing cable compartment	ES is closed	Optional feature
Electrical interlock De-module 	Closing ES	Incoming cable is without voltage	Optional feature. Voltage presence System with signalling contact is required.
Padlocks De-module Padlocks to be provided by customer 	Lock on ES	None	Standard feature (Diameter of padlock: 4 -8 mm)
	Lock cable compartment cover in closed position	None	Optional feature (Diameter of padlock: 4 -8 mm)
	Lock cable compartment cover in open position	None	Optional feature (Diameter of padlock: 4 -8 mm)
Key interlock De-module 	Key lock on ES	See details in chapter 28 "Key interlocks"	Optional feature



## 9.11 Be - Busbar earthing module

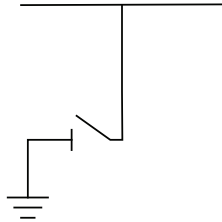
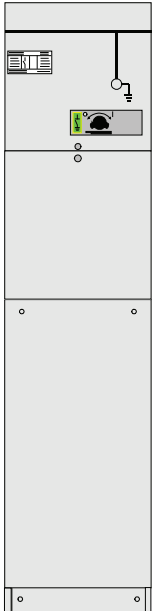

### Technical data

#### Busbar earthing

Rated voltage	kV	12	17,5	24
Power frequency withstand voltage	kV	28 <sup>1)</sup>	38	50
Impulse withstand voltage	kV	95	95	125
Rated normal current	A	630	630	630
Making capacity	kA	62,5	50	50
Short time current 1 sec	kA	25		
Short time current 3 sec.	kA	21	21	21
Number of mechanical operations		1000 close / open manual		

<sup>1)</sup> GOST version is available with 42kV power frequency withstand voltage

Depth: 765 mm

Width: 325 mm

Height: 1336 mm / optional 1100 mm

### Common features

All modules share many common features. These are described in the chapter "SafeRing/SafePlus configurations".

### Standard features

- Earthing switch
- Two position single spring mechanism
- Switch position indication for earthing switch

## 9.12 CB - Circuit-breaker module

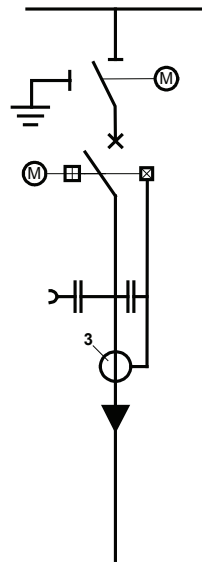
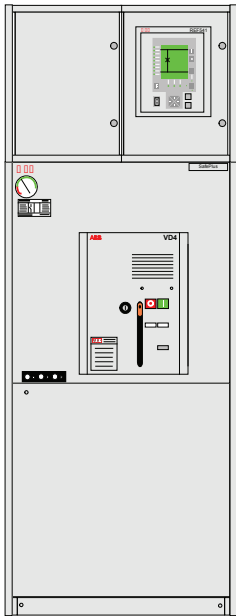

Depth: 800 mm  
 Width: 696 mm  
 Height: 1336 mm / optional 1100 mm

### Common features

All modules share many common features. These are described in the chapter "SafeRing/SafePlus configurations".

### Standard features

- 630/1250A vacuum circuit breaker
- Disconnecter
- Earthing switch
- Bushings for connection of external busbars
- Auto reclosing sequence
- Closing and tripping coil
- Combisensors with Interface C (400 series bolted)
- Low voltage compartment with different protection relays

### Optional features also available as retrofit

- Motor operated disconnecter / earthing switch
- Motor operating mechanism, circuit-breaker

### Technical data

#### Circuit-breaker module

Rated voltage	kV	12	24
Power frequency withstand voltage	kV	28 <sup>1)</sup>	50
Impulse withstand voltage	kV	95	125
Rated normal current	A	630 / 1250 <sup>2)</sup>	630 / 1250 <sup>2)</sup>
Breaking capacities:			
Short-circuit breaking current	kA	25	20
Making capacity	kA	62,5	50
Short time current 3 sec.	kA	25	20
Number of mechanical operations	30000 close / open manual		
Electrical and mechanical classes	E3, C2, M2		
Operation sequence	O - 0,3s - CO - 15s - CO		

<sup>1)</sup> GOST version is available with 42kV power frequency withstand voltage

<sup>2)</sup> For 1250 variant combisensors can not be used

### A selection of configurable functions

#### Protection:

- Non-directional overcurrent protection, 3 stages
- Directional overcurrent protection, 3 stages
- Non-directional earth-fault protection
- Directional earth-fault protection
- Residual overvoltage protection
- 3-phase thermal overload
- 3-phase overvoltage protection
- Under- or overfrequency including rate of change, 5 stages

#### Measurement:

- 3-phase current
- Neutral current
- 3-phase voltage
- Residual voltage
- 3-phase power and energy incl. cos phi
- Transient disturbance recorder

#### Optional functionality



- Capacitor bank protection
- Capacitor bank control
- Power quality
- Auto changeover

# 9.12.1 CB - Circuit-breaker module - Interlocking

### Abbreviations

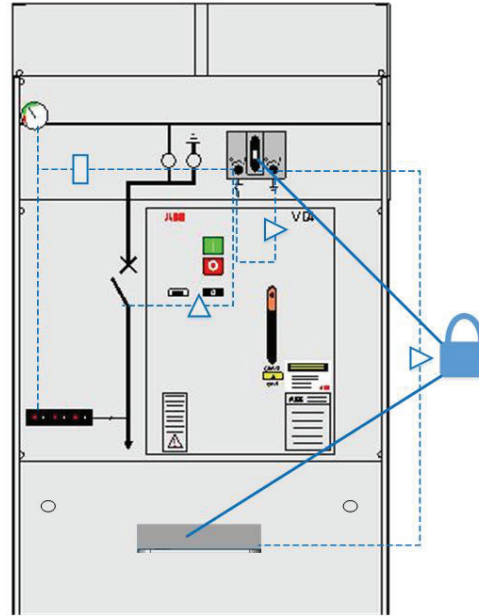
LBS	Load break switch
ES	Earthing switch
CB	Circuit breaker
SD	Switch-disconnector
SF	Switch-fuse

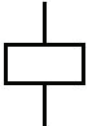

Interlock type	Operation	Condition	Comment
Mechanical interlock CB-module  	Closing CB	None	
	Opening CB	None	
	Closing SD	CB is open, ES is open, cable compartment cover is on	Cable compartment interlock is optional
	Opening SD	CB is open, ES is open	
	Closing ES	SD is open	
	Opening ES	SD is open	
	Opening cable compartment	ES is closed	Optional feature
	Closing cable compartment	ES is closed	Optional feature
Electrical interlock CB-module  	Closing ES	Incoming cable is without voltage	Optional feature. Voltage presence System with signalling contact is required.
Padlocks CB-module Padlocks to be provided by customer  	Lock cable compartment cover in closed position	None	Standard feature (Diameter of padlock: 4 -8 mm)
	Lock cable compartment cover in open position	None	Standard feature (Diameter of padlock: 4 -8 mm)

## 9.13 M - Metering module

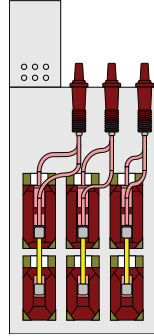

Depth: 802 mm  
Width: 696 mm  
Height: 1806 mm

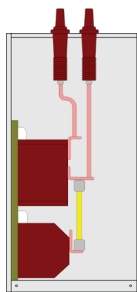
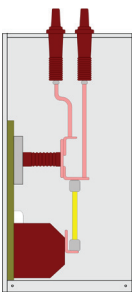
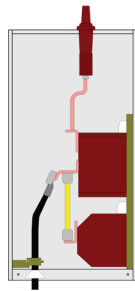
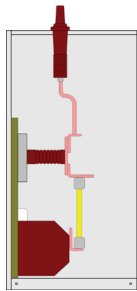
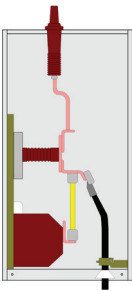

### Technical data

#### Metering module

	kV	12	17,5	24
Rated voltage	kV	12	17,5	24
Power frequency withstand voltage	kV	28 <sup>1)</sup>	38	50
Impulse withstand voltage	kV	95	95	125
Rated normal current <sup>2)</sup>	A	630	630	630
Short time current 1 sec	kA	25		
Short time current 3 sec.	kA	21	21	21

<sup>1)</sup> GOST version is available with 42kV power frequency withstand voltage

<sup>2)</sup> Limited by primary current of the current transformers

The M-module is a factory assembled, type tested, air insulated metering cubicle with conventional CTs and VTs. The M-module is designed for CTs and VTs with dimensions according to DIN 42600 Narrow type.

### Standard features

- 2 or 3 pcs (has to be specified) DIN 42600 Narrow type current transformers with ribs
- 3 pcs DIN 42600 Narrow type single pole voltage transformers
- 6 pcs bushings Interface C (400 series bolted) with connections and external busbars for SafePlus modules on left- and right-hand side
- 3 pcs bushings Interface C (400 series bolted) only required if the M-module is left-hand side or right-hand side end module
- Internal layout with CTs and VTs on left-hand side or right-hand side dependent of power direction (has to be specified)
- Padlock interlocking to prevent access to live parts

### Voltage transformers

- Single pole insulated with measuring and earth-fault windings
- Primary voltage and frequency (50 or 60 Hz) has to be specified
- Secondary windings --/110:V3/110:3V or --/100:V3/100:3V have to be specified
- Note: VTs can also be delivered without open Delta Earth fault windings
- Burden / class has to be specified

### Current transformers

- Single-core or double-core design
- Secondary side reconnectable possible
- Primary current max. 600 Amp, has to be specified
- Secondary current 5 Amp or 1 Amp has to be specified
- Burden / class has to be specified

## 9.13 M - Metering module

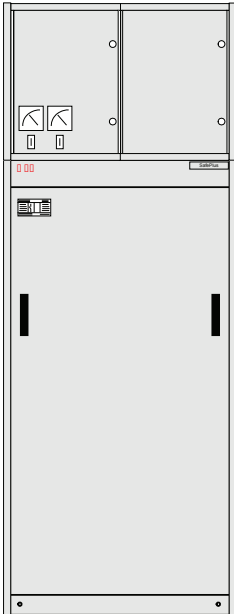

### Low voltage compartment

- Terminals for voltage transformers secondary connection
- 3-pole MCB for measuring voltage
- 1-pole MCB for earth-fault voltage
- Damping resistor for voltage transformers open delta earth fault windings to avoid ferroresonance
- Separating terminals for current transformers secondary windings
- Space for electronic kWh-meter

### Optional features

- Primary fuses for voltage transformers
- Voltmeter with selector switch, 6 positions +0
- A-meter with selector switch, 3 positions +0
- Additional meters
- Ronis key interlocking to prevent access to live parts
- Cable entry from bottom for incoming or outgoing cables
- Cable bottom entry for outgoing cable
- Metering module delivered for voltage measuring only
- Metering module delivered without low voltage equipment and wiring
- Metering module delivered without VT's and CT's, with connections only

### Optional features also available as retrofit

- Base frame (290 or 450 mm)

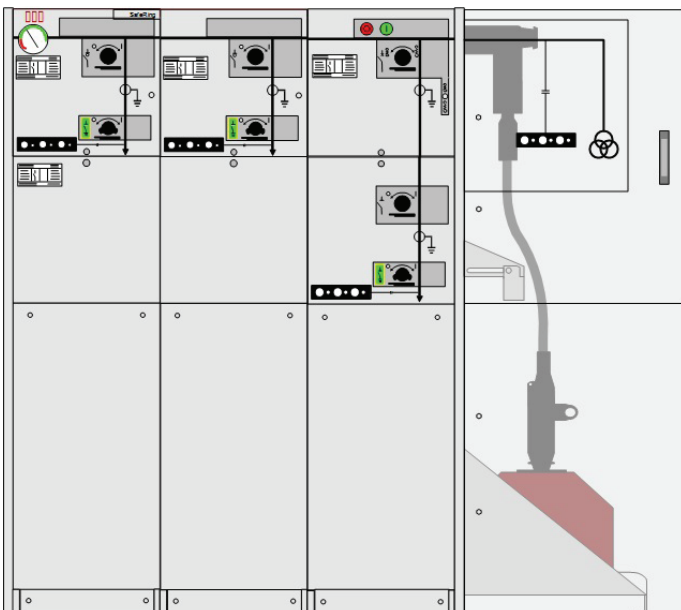

Side connected metering

Measuring voltage on the cable-in side. This solution is non-arc proof only. Installation on base frame not possible.

### Technical data

#### Metering module

Rated voltage	kV	12	24
Power frequency withstand voltage	kV	28 <sup>1)</sup>	50
Impulse withstand voltage	kV	95	125
Short time current 1 sec	kA	25	
Short time current 3 sec.	kA	21	21

<sup>1)</sup> GOST version is available with 42kV power frequency withstand voltage

## 9.14 Mt - Metering tariff module

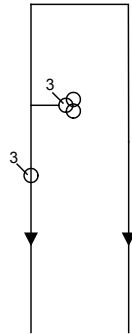
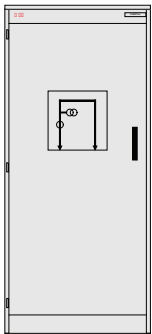

Depth: 1047 mm  
Width: 800 mm  
Height: 1806 mm

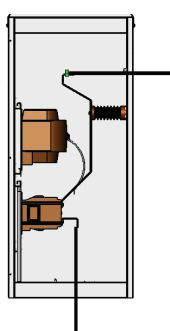
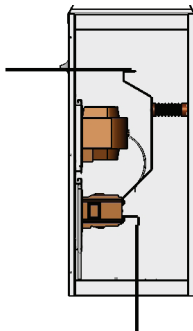
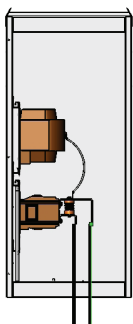
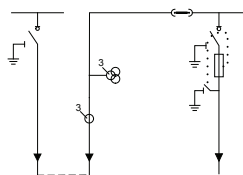
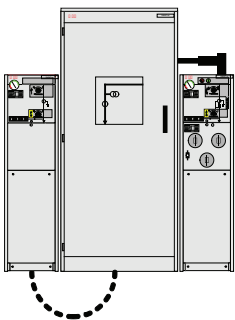

### Technical data

#### Metering tariff module

Rated voltage	kV	12	24
Power frequency withstand voltage	kV	28 <sup>1)</sup>	50
Impulse withstand voltage	kV	95	125
Rated normal current <sup>2)</sup>	A	630	630
Short time current 1 sec.	kA	20	20

<sup>1)</sup> GOST version is available with 42kV power frequency withstand voltage

<sup>2)</sup> Limited by primary current of the current transformers

The Mt-module is a factory assembled, type tested, air insulated non arc proof metering cubicle with conventional CTs and VTs. The Mt-module is designed for CTs and VTs with dimensions according to DIN 42600 Narrow type and for installation of transformers locally.

The Mt-module is manufactured and tested according to IEC 62271-200. It is available in 3 versions:

- Bottom cable in/out (A)
- Left side top connection for outgoing cable, bottom cable in (B)
- Right side top connection for outgoing cable, bottom cable in (C)

### Standard features

- 3 pcs DIN 42600 Narrow type current transformers with ribs
- 3 pcs DIN Narrow type single pole voltage transformers
- Padlock interlocking to prevent access to live parts
- MV cable connection to SafePlus cubicle using Elastimold, 3M, Pirelli, Raychem, Kabeldon, etc. connectors
- MV cable connection inside Mt-module by conventional cable lugs

### Voltage transformers

- Single pole insulated with measuring and earth-fault windings
- Primary voltage and frequency (50 or 60 Hz) has to be specified
- Secondary windings --/110:V3/110:3V or --/100:V3/100:3V have to be specified
- Note: VTs can also be delivered without open Delta Earth fault windings
- Burden / class has to be specified

### Current transformers

- Single-core or double-core design
- Secondary side reconnectable possible
- Primary current max 600 Amp, has to be specified
- Secondary current 5 Amp or 1 Amp has to be specified

## 10 Mini-metering (integrated metering)

### Features

Ring main unit configurations such as CCVm with breaker and CCFm with fuses.

- Solution is available for 3- or 4-way units for 12 and 24kV.

The measurement has to be taken from the right-hand side.

No need for separate metering module in typical ring main unit applications with one incoming/outgoing feeder.

Integrated voltage and current transformers used for tariff metering.

- CTs Class 0.2S
- VTs Class 0.2 (touch proof design)

### Customer benefits

- Space saving with one common SF6 gas tank solution
- Arc suppressors in cable switch panels for increased personnel safety
- Manometer with visible indication of arc suppressor
- Factory mounted solution with integrated VTs & CTs for reduced installation time on site
- Compact dimensions
- Cost saving with reduced footprint
- Standard design with short lead time
- Arc-proof tested solution

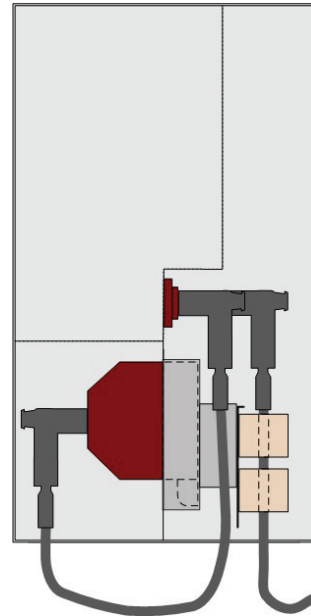

For this solution, either a base frame or cable trench is needed. The switchgear is equipped with special support bars for transport.

## 10.1 Current transformers

### Toroidal current transformers

Toroidal transformers are insulated either in epoxy-resin or encapsulated in a plastic housing. They are used either for power measuring devices or protection relays.

These transformers can be closed or split-core type. They can be used both for measuring phase current and for detecting earth-fault current. They conform to standard IEC 61869-1.

KOKM 072 xA 10 – These indoor ring core current transformers supply metering and protection devices at a maximum nominal voltage of 0.72 kV and nominal frequency of 50 or 60 Hz.

The transformers can be mounted inside the RMU switchgear. Secondary circuits can be mounted using copper wires with a cross-section up to 4 mm<sup>2</sup> (strand) or up to 6 mm<sup>2</sup> (solid conductor).

CTs with secondary current 0,075A are specially designed and applicable for self-powered relays.

KOLA and KOLMA are used for measurement of residual current (I<sub>0</sub>).



KOKM 072



KOLMA

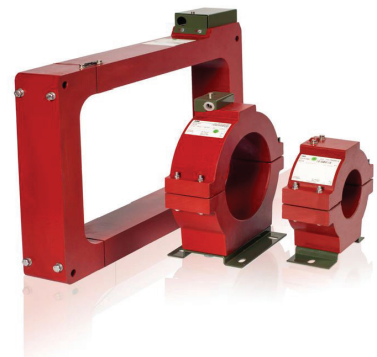

KOLA



# 11 Measuring transformers

## Current transformers to DIN standards

The DIN current transformers are insulated in resin and are used for powering measuring devices and protections. These transformers can have a wound core with one or more cores and come with performance and precision classes that suit the requirements of the installation. These devices conform to standard IEC 61869-2. Their dimensions normally comply with standard DIN 42600 Narrow Type. The current transformers can also be supplied with a capacitive socket for connection to voltage signalling devices. The ABB range of current transformers is called TPU.

TPU 4x.xx up to 12 kV  
TPU 5x.xx up to 17.5 kV  
TPU 6x.xx up to 24 kV



## Voltage transformers

The voltage transformers are insulated in epoxy resin and are used for powering measuring devices and protections. They are available for fixed assembly or on a plug-in plate for panels with withdrawable circuit-breakers. In this case, the transformers can be equipped with a medium voltage protection fuse. They conform to standard IEC 61869-3. Their dimensions comply with standard DIN 42600 Narrow Type. These transformers can have one or two poles and possess performance and precision classes that suit the functional requirements of the instruments to which they are connected. The ABB range of voltage transformers is called TJC, TDC, TJP.

TJC 4x.xx up to 12 kV  
TJC 5x.xx up to 17.5 kV  
TJC 6x.xx up to 24 kV



# 11 Measuring transformers

## Ring core current transformers and earth-fault transformers

Protection relay standard CT's typical	Ring core current transformer type	Ratio - burden
Transformer type: class 10P10	KOKM 072 or SVA 100-100-45	50-100-200/1 A 1,5/3/6 VA
Transformer type: class 5P10	KOKM 072 or SVA 100-100-45	150/1 A 4 VA
Transformer type: class 5P10	KOKM 072 or SVA 100-100-45	100-200/1 A 4 - 7 VA
Transformer type: class 5P10	KOKM 072 or SVA 100-100-45	300-600/1 A 4 - 7 VA
Transformer type: class 5P10	KOKM 072 or SVA 100-100-45	400-600/1 A 4 - 7 VA
<b>Earth-fault transformer</b>		
Earth-fault transformer, class 10P10, burden 0,5 - 15VA dependent on selected ratio	KOLMA 06A1 (90 mm)	Multi-tap secondary: 50-150/1 A or 50-750/5 A
Earth-fault transformer, class 10P10, burden 0,5 - 15VA dependent on selected ratio	KOLMA 06D1 (180 mm)	Multi-tap secondary: 50-150/1 A or 50-750/5
Earth-fault transformer, 0,5 - 20VA	KOLA 100 mm ring type	50 - 1600 A
Earth-fault transformer, 0,5 - 20VA	KOLA 180 mm ring type	50 - 1800 A
Earth-fault transformer, 0,5 - 5VA	KOLA 397 x 300 mm rectangular type	50 - 1250 A

Current transformers for self-powered relays, see chapter 24  
"Relays"

# 12 Combisensor

## Sensor variants

Two versions are available: one providing voltage measurement together with voltage indication capability (KEVCY 24 RF1), or a second one providing both of these plus the possibility of current measurement (KEVCY 24 RE1).

## Linearity

Due to the absence of a ferromagnetic core, the sensor has a linear response over a very wide primary current range, far exceeding the typical CT range.

## Current sensor

Current measurement in KEVCY 24 RE1 sensors is based on the Rogowski coil principle. A Rogowski coil is a toroidal coil, without an iron core, placed around the primary conductor in the same way as the secondary winding in a current transformer.

## Voltage sensor

Voltage measurement in KEVCY 24 RE1 and KEVCY 24 RF1 sensors is based on the capacitive divider principle.

## Sensor application

KEVCY 24 RE1 & RF1 are compact and very small bushing type sensors designed to be used in SF<sub>6</sub> gas insulated switchgear type SafeRing and SafePlus.

The external cone type of the sensor is designed according to the standard EN 50181, Interface C (400 series 630 A, M16 bolt), and therefore enables connection of all compatible cable plugs.

## Secondary cables

The sensor is equipped with two cables:

- Cable for coupling electrode with BNC connector
- Current and voltage signal cable with RJ-45 connector for connection with the IED

The cable connector for connection with the IED is type RJ-45. The sensor accuracy classes are verified up to the RJ-45 connector, i.e. considering also its secondary cable. This cable is intended to be connected directly to the IED, and subsequently neither burden calculation nor secondary wiring is needed. Every sensor is therefore accuracy tested when equipped with its own cable and connector.

Standard cable length for connection with IED: 2.2 m

Standard cable length for connection with coupling electrode: 0.45 m



## Technical data, general

Rated primary current of application	up to 630 A
Rated primary voltage of application	up to 24 kV
Highest voltage for equipment, $U_m$	24 kV
Rated power frequency withstand voltage	50 kV
Rated lightning impulse withstand voltage	125 kV

## Technical data, voltage sensor

Technical data, voltage sensor	Value
Rated primary voltage, $U_{pr}$	22/√3 kV
Maximum rated primary voltage, $U_{primax}$	22/√3 kV
Rated frequency, $f_n$	50/60 Hz
Accuracy class	0.5/3P
Rated burden, $R_{br}$	10 MOhm
Rated transformation ratio, $K_n$	10 000 : 1
Rated voltage factor, $k_u$	1.9/8h

## Technical data, current sensor

Rated primary current, $I_{pr}$	80 A
Rated transformation ratio, $K_{ra}$	80A / 0.150 V at 50 Hz 80 A / 0.180 V at 60 Hz
Rated secondary output, $U_{sr}$	3mV/Hz i.e 150 mV at 50 Hz or 180 mV at 60 Hz
Rated continuous thermal current, $I_{cth}$	630 A
Rated short-time thermal current, $I_{th}$	25 kA / 3 s
Rated dynamic current, $I_{dyn}$	63 kA
Rated frequency, $f_r$	50/60 Hz
Rated extended primary current factor, $K_{pcr}$	7.875
Accuracy limit factor, $K_{alf}$	100
Rated burden, $R_{br}$	10 MOhm

## Cables

Current and voltage sensing:	
Length	2.2 m
Connector	RJ-45 (CAT-6)
Coupling electrode:	
Length	0.45 m
Connector	BNC

# 13 SeSmart sensor

## KECA 80 C85 Indoor current sensor

With KECA 80 C85 sensors measuring class 0.5 is reached for continuous current measurement in the extended accuracy range from 5% of the rated primary current  $I_{pr}$  not only up to 120% of  $I_{pr}$  (as being common for conventional current transformers), but even up to the rated continuous thermal current  $I_{cth}$ .

For dynamic current measurement (protection purposes) the ABB sensors KECA 80 C85 fulfil requirements of protection class 5P up to an impressive value reaching the rated short-time thermal current  $I_{th}$ . That provides the possibility to designate the corresponding accuracy class as 5P630, proving excellent linearity and accuracy measurements.

## Sensor applications

The current sensors type KECA 80 C85 are intended for use in current measurement in low voltage or medium voltage switchgear. In medium voltage switchgear, the current sensor shall be installed over a bushing insulator, insulated cable, insulated & shielded cable connectors or any other type of insulated conductor. The current sensor is equipped with a clamping system which provides easy and fast installation and therefore makes the sensor suitable for retrofit purposes.

## Secondary cables

The sensor is equipped with a cable for connection with the IED. The cable connector is type RJ-45. The sensor accuracy classes are verified up to the RJ-45 connector, i.e. considering also its secondary cable. These cables are intended to be connected directly to the IED, and subsequently neither burden calculation nor secondary wiring is needed. Every sensor is therefore accuracy tested when equipped with its own cable and connector.

The design of the sensor is optimized to be easily assembled on the shielded cable connectors used with bushings designed according to the standard EN 50181, Interface C.

## Correction factors

The amplitude and phase error of a current sensor is, in practice, constant and independent of the primary current. Due to this fact it is an inherent and constant property of each sensor and it is not considered to be an unpredictable and influenced error. Hence, it can be easily corrected in the IED by using appropriate correction factors, stated separately for every sensor.

Values of the correction factors for the amplitude and phase error of a current sensor are mentioned on the sensor label (for more information please refer to Instructions for installation, use and maintenance) and should be uploaded without any modification into the IED before the sensors are put into



## Parameters for application

Rated primary current of application	up to 2500 A
<b>Sensor parameters</b>	
Highest voltage for equipment, $U_m$	0,72 kV
Rated power frequency withstand voltage	3 kV
Rated primary current, $I_{pr}$	80 A
Rated continuous thermal current $I_{cth}$	2500 A
Rated transformation ratio, $K_{ra}$	80A / 150 mV at 50 Hz 180 mV at 60 Hz
Current accuracy class	0,5/5P630
Length of cable	2,2/3,4/3,6 m

operation (please check available correction in the IED manual). To achieve required accuracy classes it is recommended to use all correction factors (Cfs): amplitude correction factor (aI) and phase error correction factor (pI) of a current sensor.

# 13 SeSmart sensor

## KEVA 24 C Indoor voltage sensor

KEVA 24 voltage sensors are intended for use in voltage measurement in gas insulated medium voltage switchgear. The voltage sensors are designed to easily replace the insulating plugs originally used in the cable T-connectors. Due to their compact size and optimized design, sensors can be used for retrofit purposes as well as in new installations.

### Correction factors

The amplitude and phase error of a voltage sensor is, in practice, constant and independent of the primary voltage. Due to this fact, it is an inherent and constant property of each sensor and is not considered to be an unpredictable and influenced error. Hence, it can be easily corrected in the IED by using appropriate correction factors, stated separately for every sensor.

Values of the correction factors for the amplitude and phase error of a voltage sensor are mentioned on the sensor label (for more information please refer to Instructions for installation, use and maintenance) and should be uploaded without any modifications into the IED before the sensors are put into operation (please check available correction in the IED manual). To achieve required accuracy classes it is recommended to use both correction factors (Cfs): amplitude correction factor (aU) and phase error correction factor (pU) of a voltage sensor.

### Parameters for application

Rated primary voltage of application	up to 24 kV
<b>Sensor parameters</b>	
Rated primary voltage, $U_{pn}$	22/√3
Highest voltage for equipment, $U_m$	24 kV
Rated power frequency withstand voltage	50 kV
Rated lightning impulse withstand voltage	125 kV
Rated continuous thermal current $I_{cth}$	2500 A
Rated transformation ratio, $K_{ra}$ for voltage measurement	10000 : 1
Voltage accuracy class	0,5/3P
Length of cable	2,2 m



### Sensor variants and use in cable T-connectors

Sensor type designation	Cable T-connectors	
	Manufacturer	Type
KEVA 24 C10	Nexans-Euromold	400 TB/G
		440 TB/G
		K400 TB/G
		K440 TB/G
		400PB-XSA
KEVA 24 C21	Kabeldon	CSE-A 12630
		CSEP-A 12630
		CSE-A 24630
		CSEP-A 24630
		SOC 630 - 1/2
KEVA 24 C22	NKT	CB 12-630
		CC 12-630
		CB 24-630
		CC 24-630
	Raychem	RSTI L56xx
		RSTI-CC L56xx
KEVA 24 C23	Raychem	RSTI 58xx/39xx
		RSTI CC 58xx/39xx
		RSTI LCxx/LAxx (older)
	NKT	CB 12-630
		CC 12-630
		CB 24-630
		CC 24-630

# 14 Mechanisms

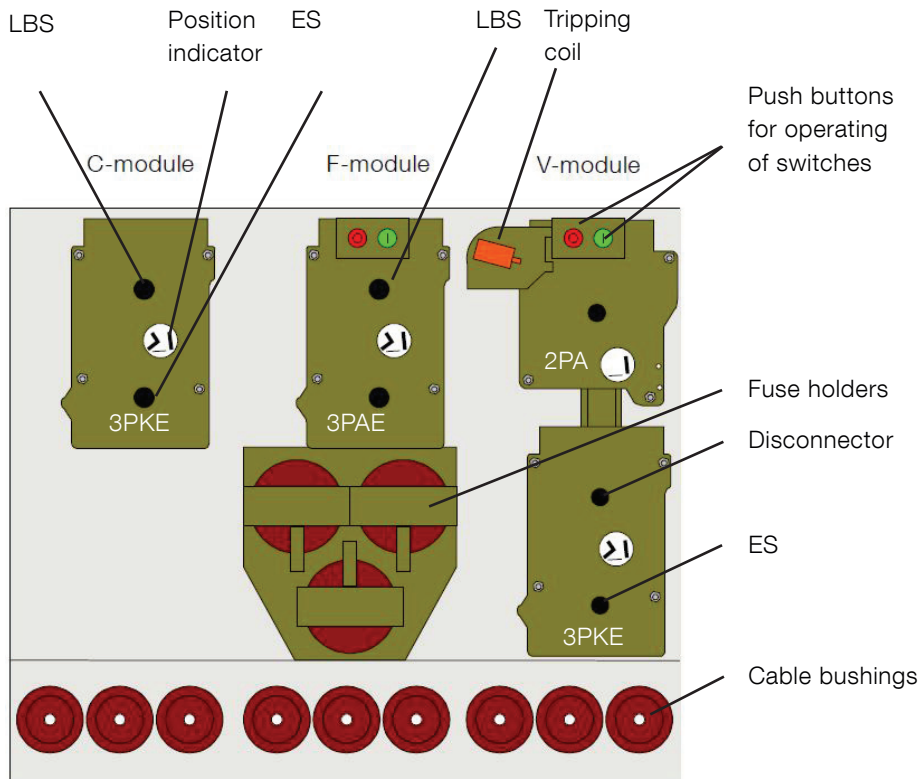

Mechanisms front view.  
SF<sub>6</sub>-tank with operating mechanisms.

All operating mechanisms are situated outside the SF<sub>6</sub>-tank behind the front covers with degree of protection of IP2X.

This allows for easy access to all operating mechanisms if retrofit or service should be required. The speed of operation of these mechanisms is independent of the operator.

To prevent access to the cable compartment before the earthing switch is in closed position, all mechanisms can as an option be supplied with mechanical interlocks which make it impossible to remove the cable compartment covers. It will then also be impossible to operate load break / disconnector switch to open position before the cable compartment cover is mounted properly.

Each mechanism is equipped with a padlocking device. When adding a padlock to this device, access to operate the mechanism will be impossible. This device has three holes; the diameter of suitable padlock is 4 - 8 mm.

All operating mechanisms are equipped with position indicators for all switches. In order to achieve true indication, indicators are directly connected to the operating shafts of the switches inside the SF<sub>6</sub>-tank. Please see shafts shown with red colour on next page.

Operating handle has an anti-reflex system which prevents an immediate re-operation of the switch.

# 14 Mechanisms

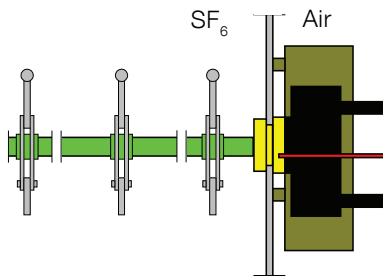

C-mechanism

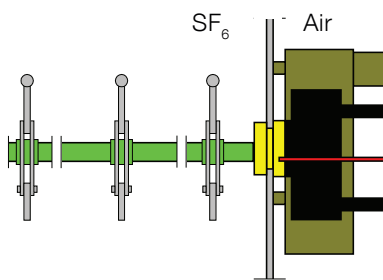

F-mechanism

## Cable switch module and busbar sectionalizer with load break switch

The mechanism (3PKE) has two operating shafts: the upper one for the load break switch and the lower one for the earthing switch.

Both shafts are single spring operated and operate one common shaft which is directly connected to the three position switch (CFE-C) inside the SF<sub>6</sub>-tank. When both load break switch and earthing switch are in open position, the switch satisfies the specifications of disconnector.

Due to the mechanical interlock between the upper and lower operating shaft, it is impossible to operate the load break switch when the earthing switch is in earthed position or to operate the earthing switch when the load break switch is in closed position.

## Switch-fuse module

The mechanism (3PAE) has two operating shafts: the upper one for the load break switch and the lower one for the earthing switch.

The upper one operates two springs: one for closing and one for opening. Both springs are charged in one operation. By means of mechanical push buttons it is then possible to close and open the load break switch.

The opening spring is always charged when the load break switch is in closed position and will be ready to open the load break switch immediately if one of the HV-fuse-links blows. The blown fuse-link(s) has/have to be replaced before the operator will be able to close the load break switch again. According to IEC 60282-1, all three fuse-links should be replaced, even if only one or two have operated.

The lower shaft is single spring operated. Both operating shafts operate one common shaft which is directly connected to the three position switch (CFE-F) inside the SF<sub>6</sub>-tank. Due to the mechanical interlock between the upper and lower operating shaft, it is impossible to operate the load break switch when the earthing switch is in earthed position or to operate the earthing switch when the load break switch is in closed position.

It will also be impossible to access the fuse compartment before the earthing switch is in closed position.

## 14 Mechanisms

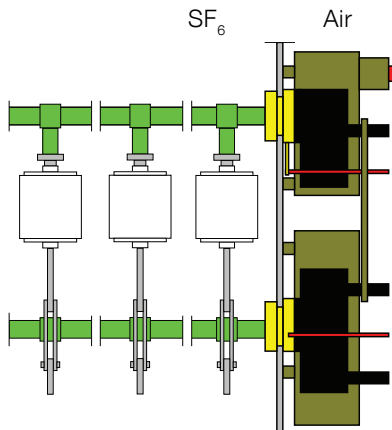

V-mechanism

### Vacuum circuit breaker and busbar sectionalizer with circuit breaker

These two modules have two mechanisms: the upper one (2PA) with one operating shaft is for the circuit-breaker and the lower one (3PKE) with two operating shafts is for the disconnecter and earthing switch.

The upper mechanism has two operating spring: one for closing and one for opening.

Both springs are charged in one operation. By means of mechanical push buttons it is then possible to close and open the circuit breaker.

The opening spring is always charged when the circuit breaker is in closed position and will be ready to open immediately if the protection relay gives a trip signal.

However, a quick reclosing is not possible. If the mechanism is equipped with a motor operation a reclosing will take approximately 10 seconds.

The lower mechanism is identical to the one described above for the cable switch module.

There is a mechanical interlock between these two mechanisms which prevents operating of the disconnecter and earthing switch when the circuit breaker is in closed position. When the earthing switch is in closed position it will be impossible to operate the disconnecter, but the circuit breaker can be closed for testing purpose.

### High duty vacuum circuit-breaker V25/V20

This module has two mechanisms: the upper one (EL2) is for the circuit-breaker and the lower one (3PKE) with two operating shafts is for the disconnecter and earthing switch. The vacuum circuit-breaker has the possibility of rapid auto-reclosing duty.

By means of mechanical push buttons it is possible to close and open the circuit-breaker. The opening spring is always charged when the circuit-breaker is in closed position and will be ready to open immediately if the protection relay gives a trip signal. If the mechanism is recharged after closing, it is possible to perform open - close - open sequence.

The lower mechanism is identical to the one described above for the cable switch module.

There is a mechanical interlock between these two mechanisms which prevents operating of the disconnecter and earthing switch when the circuit-breaker is in closed position. When the earthing switch is in closed position it will be impossible to operate the disconnecter, but the circuit-breaker can be closed for testing purpose.



## 15 Cable bushings

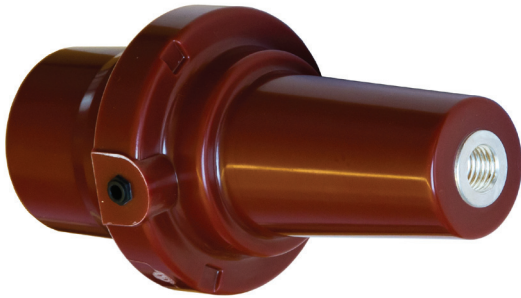

The connection of the HV-cables is made by cable bushings. The bushings are made of cast resin epoxy with moulded-in conductors. In addition, a screen is moulded in to control the electrical field and is also used as the main capacitor supplying the voltage indicating systems.

Up-to-date production facilities and highly advanced robots and test equipment ensure the high quality required for each single device.

A very high number of units have been installed worldwide in distribution networks, power stations and industrial complexes.

Used together with full-screened connectors, an ideal solution for areas with humidity or condensation problems is achieved. The bushings are designed according to CENELEC EN 50181, EDF HN 52-S-61 and IEC 60137.

There are 5 different types of cable bushings available:

- Interface A (200 series with plug-in contact,  $I_n=200A$ )
- Interface B (400 series with plug-in contact,  $I_n=400A$ )
- Interface C (400 series with M16 bolted contact,  $I_n=630A$ )
- Interface C (400 series with M16 bolted contact) and integrated voltage and current sensors ( $I_n=630A$ )
- Interface D (600 series with M16 bolted contact,  $I_n=600A$ )

## 16 Cable termination

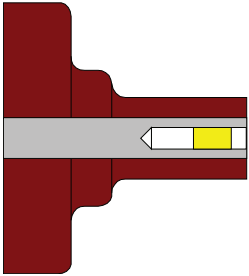

The following cable bushings are available as standard:

Interface A with plug

200 series,  $I_n = 200\text{ A}$

Standard on F and V modules ( $I_n = 200\text{ A}$ )

The yellow area indicates the silver coated contact spring.

Cable cross-section: See tables 16.1.1 and 16.2.1.

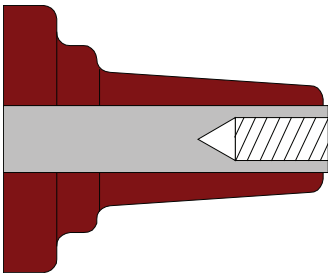

Interface C with M16 x 2 metric threads

400 series,  $I_n = 630\text{ A}$

Standard on C, V ( $I_n=630\text{A}$ ), D and De modules; and for top extension

Cable cross-section: See tables 16.1.2 and 16.2.2..

Cable bushings Interface B and D are also available on request.

The installation instructions from the manufacturer of cable terminations must be followed. Be sure to lubricate the bushings thoroughly with the silicone supplied.

Where cables are not connected, the earthing switch must be locked in closed position or the bushings must be fitted with dead end receptacles before the unit is energized.

## 16 Cable termination

All bushings are situated at the same height from the floor and are protected by a cable compartment cover. The three drawings below show typical arrangements with cable connectors for single and double cables.

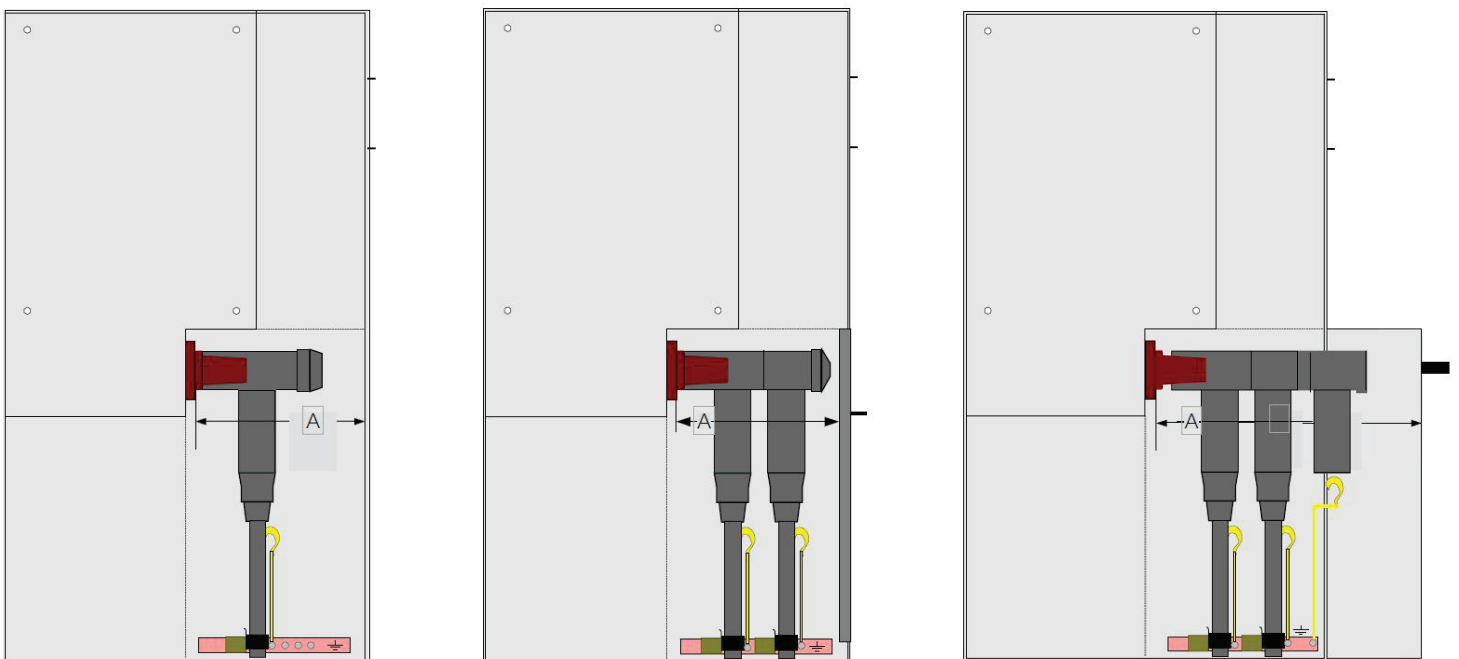

The table below shows the net distance A in millimeters from cable bushing to the inner part of cable compartment cover.

Cable compartment type	Interface A (200 series plug-in)	Interface C (400 series bolted)
Standard	400	360
With window	392	353
Arc proof with/without window	377	337
Deep	595	555

The following manufacturers of cable terminations are recommended:

ABB Kabeldon  
 Südkabel  
 Euromold/Elastimold  
 nkt cables  
 Tyco Electronics  
 Prysmian  
 3M

## 16 Cable termination



CSE-A 12250  
CSE-A 24250



CSE-A 12400  
CSE-A 24400



CSE-A 12630  
CSE-A 24630

### Screened separable cable connectors CSE-A 12-24 kV, 250 A, 400 A, 630 A

#### Application area

Pre-moulded, screened, separable connectors for XLPE insulated 1- or 3-core cables with aluminum or copper conductors for 12–42 kV. Can be installed both indoors and outdoors.

Fits standard bushings of outer cone type according to EN 50181. Connectors with rated current:

- 250 A: interface type A with plug-in Ø 7.9 mm
- 400 A: interface type B with plug-in Ø 14 mm
- 630 A: interface type C with bolt M16

#### Standard

Meets the requirements of:

- CENELEC, HD 629.1 S2

#### Design

CSE-A is premoulded and manufactured in rubber with three layers, a conductive inner layer, an insulation layer and a conductive outer layer, that are vulcanized together for the best possible interface between the layers.

The cable connectors include both a capacitive test point with protection and an integrated earthing wire.

- Delivered in 3-phase kits, complete with cable lugs, bolt connection and stress grading adapter, designed to ensure a reliable installation.

#### Note:

- For 3-core cable with common Cu-screen wires, a screen separation kit must be used.

Designation	XLPE/EPR Ø mm <sup>2</sup>	Conductor cross section mm <sup>2</sup>	Rated current	Bushing type	Weight kg/unit
<b>Elbow cable connector with capacitive test point, 12kV</b>					
CSE-A 12250-01	10 - 12	10 - 16	250 A	Interface type A with plug-in Ø 7.9 mm	2.2
CSE-A 12250-02	13 - 22	25 - 95	250 A	Interface type A with plug-in Ø 7.9 mm	2.2
CSE-A 12400-01	13 - 20	25 - 70	400 A	Interface type B with plug-in Ø 14 mm	6.1
CSE-A 12400-02	18.5 - 30.5	95 - 300	400 A	Interface type B with plug-in Ø 14 mm	6.6
CSE-A 12630-01	13 - 20	25 - 70	630 A	Interface type C with bolt M16	5.1
CSE-A 12630-02	18.5 - 30.5	95 - 300	630 A	Interface type C with bolt M16	5.5
CSE-A 12630-03	30.5 - 45.0	400 - 630	630 A	Interface type C with bolt M16	7.7
<b>Elbow cable connector with capacitive test point, 24kV</b>					
CSE-A 24250-01	13 - 22	10 - 16	250 A	Interface type A with plug-in Ø 7.9 mm	2.2
CSE-A 24250-02	17.0 - 25.5	25 - 95	250 A	Interface type A with plug-in Ø 7.9 mm	2.2
CSE-A 24400-01	17 - 24	25 - 70	400 A	Interface type B with plug-in Ø 14 mm	6.1
CSE-A 24400-02	22.5 - 35.0	95 - 300	400 A	Interface type B with plug-in Ø 14 mm	6.6
CSE-A 24630-01	17 - 24	25 - 70	630 A	Interface type C with bolt M16	5.1
CSE-A 24630-02	22.5 - 35.0	95 - 300	630 A	Interface type C with bolt M16	5.5
CSE-A 24630-03	30.5 - 45.0	400 - 630	630 A	Interface type C with bolt M16	7.7

## 16.1 Cable termination 12 kV

Table 16.1.1

12 kV: Separable connectors interface A with earthing shield, $I_r = 250$ A			
Manufacturer	Designation	Conductor [mm <sup>2</sup> ]	XLPE / EPR Ø [mm]
3M	93-EE 605-2/-95	25-95	12.2-25.0
3M	92-EE 615-2/-120	120	19.8-22.8
3M	92-EE 615-2/-150	150	21.3-24.3
ABB Kabeldon	CSE-A 12250-01	10-16	10.0-12.0
ABB Kabeldon	CSE-A 12250-02	25-95	13.0-22.0
Euromold	158LR/G	16-70	12.6-18.7
Euromold	158LR	70-95	18.4-26.4
nkt cables	EASW 10/250	25-95	12.7-19.2
nkt cables	CE 12-250	95-120	16.9-25.0
Prysmian	FMCE-250	16-95	10.0-21.3
Südkabel	SEW 12	25-150	12.2-25.0
Tyco Electronics	RSES	16-120	13.5-33.5

For dynamic and thermal short-circuit currents, please compare the values expected in your network with the rated values of the connector from the different suppliers

# 16.1 Cable termination 12 kV

Table 16.1.2

12 kV: Separable connectors interface C, I <sub>n</sub> = 630 A							Cable compartment with											
Manufacturer	Designation	Conductor [mm <sup>2</sup> ]	XLPE / EPR Ø [mm]	Earthing shield Yes / No	Additional equipment for dual cable arrangement	Surge Arrester with	Single cable + surge arrester											
							Standard Distance A = 360 mm				Dual cables							
							With window Distance A = 353 mm	Arc proof Distance A = 337 mm	Deep Distance A = 555 mm	Standard Distance A = 360 mm	With window Distance A = 353 mm	Arc proof Distance A = 337 mm	Deep Distance A = 555 mm					
3M	93-EE 705-6/-95	50-95	15.0-23.5	Y	KU 23.1+93-EE 705-6/95	MUT 23												
3M	93-EE 705-6/-240	120-240	21.8-32.6	Y	93-EE 718-6/150-240	MUT 23												
ABB Kabeldon	CSE-A 12630-01	25-70	13.0-20.0	Y	CSEP-A 12630-01	CSAP-A 12	X	X		X	X	X	X					X
ABB Kabeldon	CSE-A 12630-02	95-300	18.5-30.5	Y	CSEP-A 12630-02	CSAP-A 12	X	X	X	X	X	X	X					X
ABB Kabeldon	CSE-A 12630-03	400-630	30.5-45.0	Y	CSEP-A 12630-03	CSAP-A 12	X	X		X	X	X	X					X
Euromold	430TB/G	25-300	12.0-37.5	Y	300 PB/G <sup>2)</sup>	300SA <sup>2)</sup>	X	X	X	X	X	X	X	X	X	X	X	X
Euromold	484TB/G <sup>3)</sup>	50-630	16.0-56.0	Y	804PG/G <sup>2)</sup>	800SA <sup>2)</sup>	X	X	X	X	X	X	X	X	X	X	X	X
nkt cables	CB12-630	25-300	12.7-34.6	Y	CC 12-630	CSA 12	X	X	X	X	X	X	X	X	X	X	X	X
nkt cables	AB12-630	25-300	12.7-34.6	N	AC 12-630	ASA 12	X	X	X	X	X	X	X	X	X	X	X	X
nkt cables	CC24-630(1250)	400-630	34.0-45.6	Y	CC24-630(1250) or CC 12-630	CSA 12	X	X	X	X	X	X	X	X	X	X	X	X
Prysmian	FMCTs-400	70-300	18.5-30.4	Y	FMPCs-400-12+ FMCTs-400	Yes <sup>1)</sup>				X								X
Prysmian	FMCTs-400/1250	70-300	18.5-42.0	Y	FMPCs-400-12+ FMCTs-400/1250	Yes <sup>1)</sup>				X								X
Südkabel	SET 12	50-300	15.0-32.6	Y	SEHDK 13.1	MUT 23	X	X	X	X								X
Südkabel	SET 12	50-300	15.0-32.6		KU 23.2/22 +SET 12	MUT 23	X	X	X	X								X
Südkabel	SEHDT 13	400-500	31.3-36.4	Y	None	KU33+MUT 23				X								
Tyco Electronics	RSTI-L	25-300	12.7-34.6	Y	RSTI-CC-L	RSTI-SA	X	X	X	X	X	X	X	X	X	X	X	X
Tyco Electronics	RICS	25-300	Flexible	N	None	RDA	X	X	X	X								
Tyco Electronics	RSTI-36Lxx	400-630	28.9-45.6	Y	RSTI-66CP-M16+ RSTI-36Lxx	None				X								X

<sup>1)</sup> Combination with surge arrester possible with Euromold 400PBX-XSA

<sup>2)</sup> For dual cable + surge arrester, deeper cable compartment is required. Solution available for Euromold connectors only.

<sup>3)</sup> Available up to 1250 A.

Separable connectors without earthing shield are not recommended.

For dynamic and thermal short-circuit currents, please compare the values expected in your network with the rated values of the connector from the different suppliers

## 16.2 Cable termination 24 kV

Table 16.2.1

24 kV: Separable connectors interface A with earthing shield, $I_s = 250$ A			
Manufacturer	Designation	Conductor [mm <sup>2</sup> ]	XLPE / EPR Ø [mm]
3M	93-EE 605-2/-95	25-95	12.2-25.0
3M	93-EE 615-2/-120	120	24.0-27.0
3M	93-EE 615-2/-150	150	25.5-28.5
ABB Kabeldon	CSE-A 24250-01	10-16	13.0-22.0
ABB Kabeldon	CSE-A 24250-02	25-95	17.0-25.5
Euromold	K158LR/G	16-25	12.6-18.7
Euromold	K158LR	25-95	18.4-26.4
nkt cables	EASW 20/250	25-95	17.0-25.0
nkt cables	CE 24-250	25-120	16.9-25.0
Prysmian	FMCE-250	35-95	18.6-26.0
Südkabel	SEW 24	25-95	17.3-25.0
Tyco Electronics	RSES	16-120	13.5-33.5

Separable connectors without earthing shield are not recommended.

For dynamic and thermal short-circuit currents, please compare the values expected in your network with the rated values of the connector from the different suppliers.

## 16.2 Cable termination 24 kV

Table 16.2.2

24 kV: Separable connectors interface C with earthing shield, I <sub>r</sub> = 630 A						Cable compartment with								
Manufacturer	Designation	Conductor [mm <sup>2</sup> ]	XLPE / EPR Ø [mm]	Additional equipment for dual cable arrangement	Surge Arrester with	Single cable + surge arrester				Dual cables				
						Standard Distance A = 360 mm	With window Distance A = 353 mm	Arc proof Distance A = 337 mm	Deep Distance A = 555 mm	Standard Distance A = 360 mm	With window Distance A = 353 mm	Arc proof Distance A = 337 mm	Deep Distance A = 555 mm	
3M	93-EE 705-6/-95	50-95	15.0-23.5	KU 23.1+93-EE 705-6/-95	MUT 23	X	X	X	X					X
3M	93-EE 705-6/-240	95-240	21.8-32.6	93-EE 718-6/150-240	MUT 23	X	X	X	X	X	X	X	X	X
ABB Kabeldon	CSE-A 24630-01	25-70	17.0-24.0	CSEP-A 24630-01	CSAP-A 24	X	X		X	X	X			X
ABB Kabeldon	CSE-A 24630-02	95-300	22.5-35.0	CSEP-A 24630-02	CSAP-A 24	X	X	X	X	X	X			X
ABB Kabeldon	CSE-A 24630-03	400-630	30.5-45.0	CSEP-A 24630-03	CSAP-A 24	X	X		X	X	X			X
Euromold	K400TB/G	25-300	12.0-37.5	K400CP-SC+K400TB/G	400PB-XSA				X					X
Euromold	K430TB/G	25-300	12.0-37.5	K300PB/G	300SA	X	X	X	X	X	X	X	X	X
Euromold	K484TB/G	35-630	16.0-56.0	K804PB	800SA	X	X	X	X	X	X	X	X	X
nkt cables	CB24-630	25-300	12.7-34.6	CC 24-630	CSA 24	X	X	X	X	X	X	X	X	X
nkt cables	CC24-630(1250)	400-630	34.0-45.6	CC24-630(1250) or CC24-630	CSA 24	X	X	X	X	X	X	X	X	X
Prysmian	FMCTs-400	35-300	18.5-35.3	FMPCs-400-24 + FMCTs-400	Yes <sup>1)</sup>				X					X
Prysmian	FMCTs-400/1250	35-630	18.5-47.1	FMPCs-400-24 + FMCTs-400/1250	Yes <sup>1)</sup>				X					X
Südkabel	SET 24	25-240	15.0-32.6	SEHDK 23.1	MUT 23	X	X	X	X	X	X	X	X	X
Südkabel	SET 24	25-240	15.0-32.6	KU 23.2/23 + SET 24	MUT 23	X	X	X	X					X
Südkabel	SEHDT 23.1	300	31.9-34.6	KU 23.2/23+ SEHDT 23.1	MUT 23	X	X	X	X					X
Südkabel	SEHDT 23	300-500	31.9-40.6	None	KU33+ MUT 23				X					
Tyco Electronics	RSTI-L	25-300	12.7-34.6	RSTI-CC-L	RSTI-SA	X	X	X	X	X	X	X	X	X
Tyco Electronics	RSTI-56Lxx	400-630	34.0-45.6	RSTI-66CP-M16 + RSTI-56Lxx	None				X					X

<sup>1)</sup> Combination with surge arrester possible with Euromold 400PBX-XSA

For dynamic and thermal short-circuit currents, please compare the values expected in your network with the rated values of the connector from the different suppliers.

Separable connectors without earthing shield are not recommended.



## 17 Cable test bushings



As an option, both C- and De-modules can be equipped with cable test bushings situated behind the lower front cover. This cover can be interlocked against the earthing switch to avoid access to the cable test compartment before the earthing switch is in closed position.

When these bushings are mounted, cable insulation tests can easily be done according to the following procedure:

### Principle sketch for testing:

1. Close the earthing switch after having checked the voltage indicators
2. Open compartment cover
3. Install the injection device onto the access terminals
4. Open the removable earthing bridge
5. Perform cable testing
6. Re-install the earthing bridge
7. Remove the injection device
8. Close compartment cover
9. Open the earthing switch

If the switchgear is not equipped with cable test bushings, cable testing is possible directly at the cable connectors if they are designed for this purpose. Please follow the supplier's instruction. For interlocking on the cable test cover, see interlock table for C-module, chapter 9.2.1.

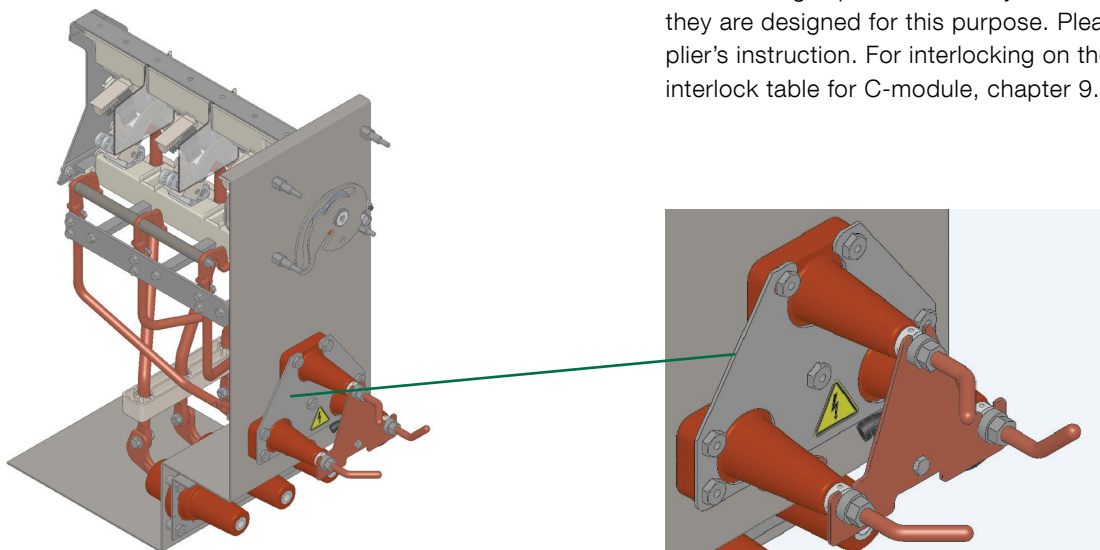

## 18 Extension of switchgear

### 18.1 External busbars on top

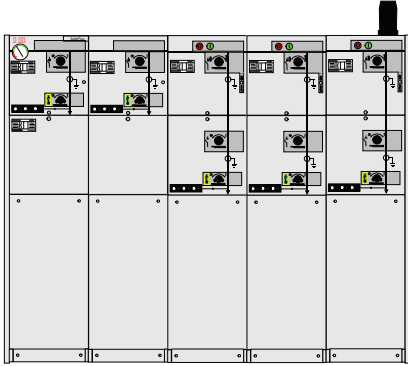

SafePlus prepared for future extension on right hand side

On the top of all SafeRing and SafePlus switchgears it is possible as an option to have bushings for connection of external busbars on the left and / or right side.

For a SafePlus switchgear consisting of only one module, only one set of bushings on the top is used.

When bushings are mounted on the top, you will have these possibilities:

1. When adding a dead end receptacle to each of these bushings, SafeRing/SafePlus will be prepared for future busbar extension.
2. With an external busbar kit, it is possible to connect two or more sections.

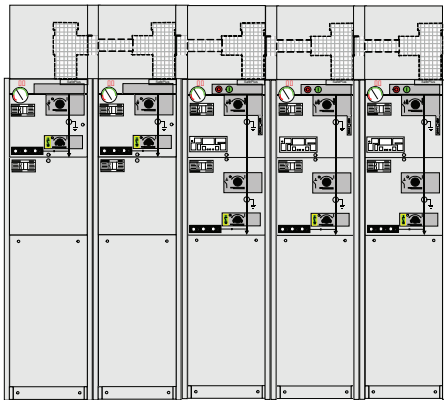

Fully modular SafePlus with external busbar cover

Since a 5-way switchgear is the maximum size within one common SF<sub>6</sub>-tank, the busbar kit allows a configuration with more than 5 modules.

The installation of the external busbars has to be done on site. See manual 1VDD006006 GB for installation instructions.

The complete extension kit and the dead end receptacles are fully screened, earthed and insulated with EPDM rubber. This makes a safe and reliable switchgear extension. In addition, protection covers are available as an option.

SafePlus switchgear can also be configured as fully modular. This results in a 1250 A busbar rating.

The busbars between the modules and the end adapters used on the left and right side are identical to the parts used in the previous example. For the three modules in the middle, a special cross adapter is used.

The length of the external busbars are dependent on the type of modules to be connected.

Connection by external busbars is available for all modules except the Mt-module.

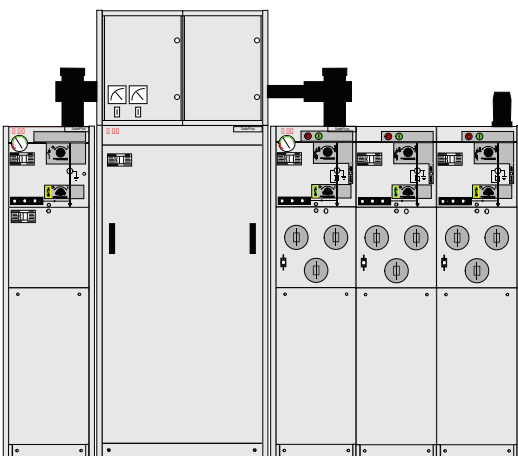

SafePlus with one incomer (C-module), one Metering module (M-module) and three fused T-offs (F-modules), prepared for future extension

## 18.2 Side extension

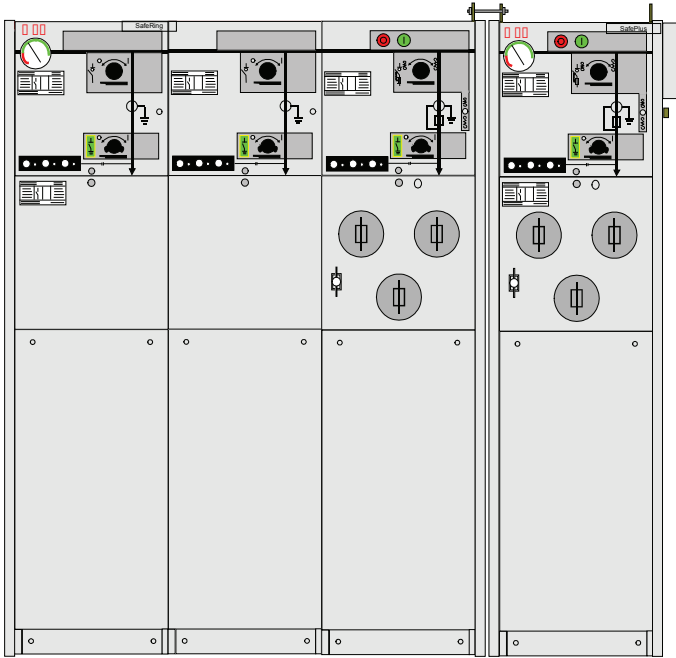

It is possible to have optional bushings on the left or right side of SafeRing or SafePlus C- or F-modules for side connection of external busbars. The rated current of the side connection is limited to 400A.

For a 1-way SafePlus C- or F-module, one or two sets of bushings can be installed. This is also applicable for a 2-way unit.

When bushings are mounted on the side, you will have these possibilities:

1. When adding a dead end receptacle to each of these bushings, SafeRing/SafePlus will be prepared for future busbar extension.
2. With a specially designed connection kit, it will be possible to connect two or more sections.

Since a 5-way switchgear is the maximum size within one common SF<sub>6</sub>-tank, the busbar kit allows a configuration with more than 5 modules. The second switchgear can consist of maximum 2 modules.

The installation of the external busbars has to be done on site. See manual 1VDD006106 GB for installation instructions.

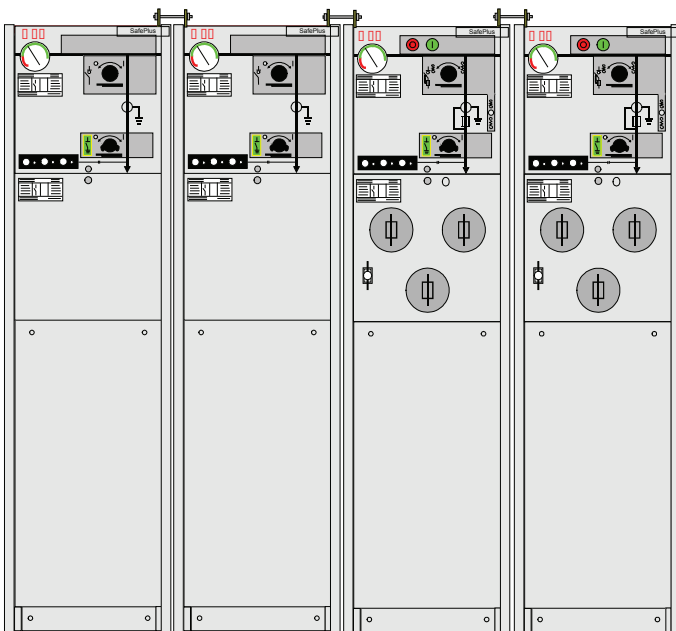

SafePlus switchgear can also be configured as fully modular. The busbars between the modules and the end adapters used on the leftmost and rightmost module are identical to the parts used in the previous example.

# 19 Base frame

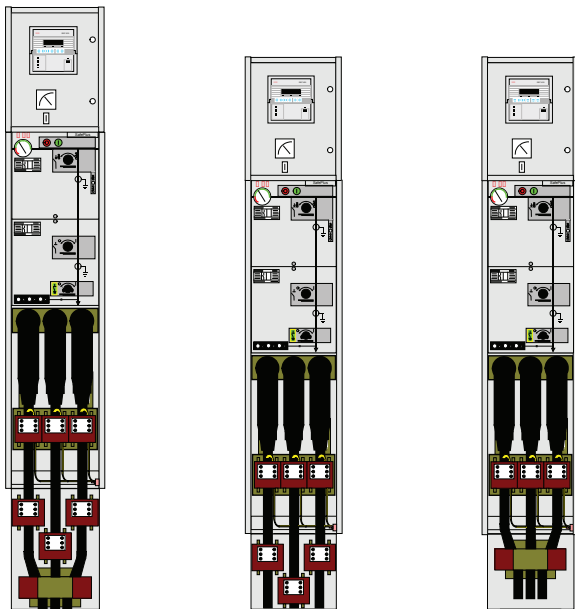

Base frame 450 mm with earth-fault transformer and extra set of current transformers

Base frame 290 mm with an extra set of current transformers

Base frame 290 mm with earth-fault transformers

When SafeRing or SafePlus are placed directly on a floor, the height from the floor to the centre of the cable bushings is 595 millimeter. If there is no cable trench, this height might not be sufficient for proper installation of cables. It is then possible to place the switchgear on an additional base frame.

This base frame is available in two different heights; 290 and 450 millimeter.

Inside the standard cable compartment for the vacuum circuit-breaker there will be enough space for three current transformers for protection relay.

If an earth-fault transformer or an extra set of current transformers are required, an additional base frame is necessary, please see examples on left hand side.

The base frame has openings for cable entrance from the bottom and from both sides. It is delivered as a kit and has to be assembled on site.

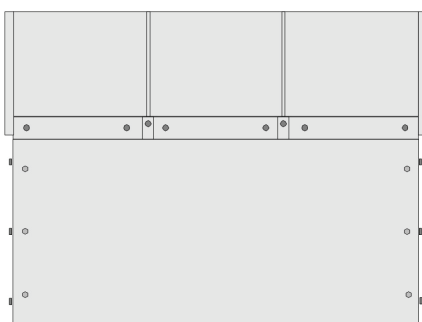

Front view

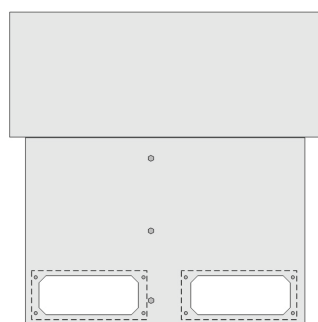

Side view

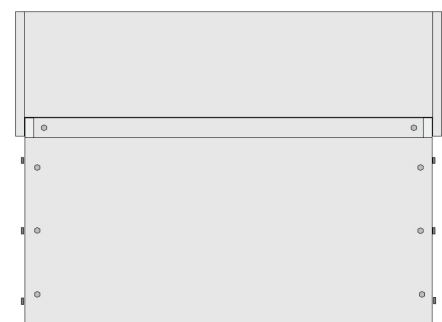

Rear view

## 20 Low voltage compartment / Top entry box

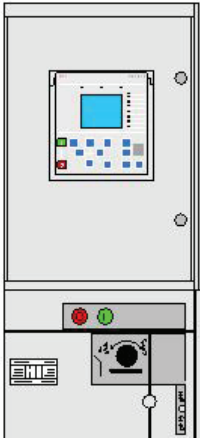

Low voltage compartment with REF615 relay

### Low voltage compartment

All SafePlus switchgears can be supplied with an optional low voltage compartment.

This compartment may be equipped with protection relays, meters, position switches, terminal blocks etc.

The compartment is fixed to the side covers of the SF<sub>6</sub>-tank and must cover the total width of the switchgear.

Each module has a separate hinged door, but there are no partition walls between the modules.

The low voltage compartment has the possibility of external cable entry from either left- or right-hand side.

A locking system for the door is available on request.

Different heights for the low voltage compartment are available: 470, 570, 700, 800 mm)

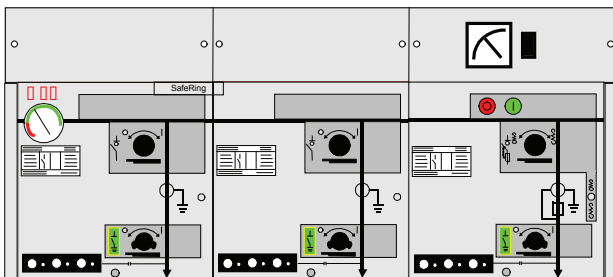

Top entry box with A-meter and selector switch

### Top entry box

If motor operation, coils, auxiliary switches, self-powered protection relay etc. are mounted on a SafeRing or SafePlus module, the terminal blocks and the wiring are located behind the front covers.

However, an additional top entry box can be mounted on the top of all SafeRing and SafePlus switchgears. Since the top entry box is fixed to the side covers of the SF<sub>6</sub>-tank, the total width of the switchgear must be covered.

The top entry box allows entrance of the customer's low voltage wiring from the rear side, left-hand side and right-hand side.

Furthermore, the top entry box gives the opportunity to install ammeters with position switches, a local/remote switch for motor operation etc.

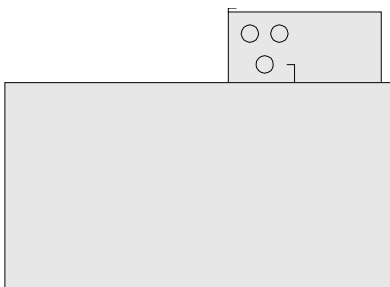

Side view top entry box

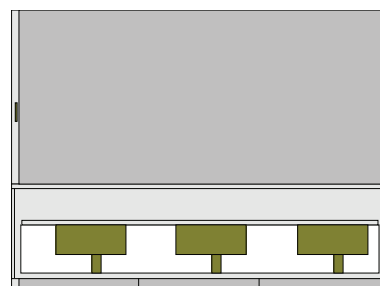

Top entry box seen from above when front / top covers have been removed

## 21 Motor operation

Closing and opening operations of load-break switches and charging of the springs of the mechanisms for the circuit-breaker and the switch-fuse combination may be performed by a motor operation.

The disconnecter in the V-module and all earthing switches do not have this possibility.

All motor devices require DC voltage. If the control voltage is either 110 or 220 VAC, a rectifier is integrated in the control unit.

The operating cycle for motor operation is CO - 3 min (i.e. it may be operated with a frequency of up to one close and one open operation every third minute). Motors and coils can easily be mounted to the mechanisms after delivery (retrofit).

Test voltage for tables below is + 10/ - 15 % for motor operations and closing coils and +10/ -30% for trip coils and opening coils.

The motor and coils can easily be mounted to the mechanisms after delivery (retro-fit).

Characteristics of motor operation for C-module

Rated voltage (V)	Power consumption (W) or (VA)	Operation times		Peak start current (A)	Fuse
		Closing time (s)	Opening time (s)		
24	90	6 - 9	6 - 9	14	F 6,3 A
48	150	4 - 7	4 - 7	13	F 4 A
60	90	6 - 9	6 - 9	7	F 4 A
110	90	6 - 9	6 - 9	3	F 2 A
220	90	6 - 9	6 - 9	1,7	F 1 A

Characteristics of motor operation for F-module

Rated voltage (V)	Power consumption (W) or (VA)	Operation times		Peak start current (A)	Fuse
		Charge/Closing time (s)	Opening time (ms)		
24	160	9-14	40-60	14	F 6,3 A
48	200	5-9	40-60	13	F 4 A
60	140	8-13	40-60	7	F 4 A
110	140	8-13	40-60	3	F 2 A
220	140	8-13	40-60	1,7	F 1 A

Characteristics of motor operation for V-module

Rated voltage (V)	Power consumption (W) or (VA)	Operation times		Peak start current (A)	Fuse
		Charge/Closing time (s)	Opening time (ms)		
24	180	10-17	40-60	14	F 6,3 A
48	220	5-9	40-60	13	F 4 A
60	150	9-13	40-60	7	F 4 A
110	170	9-13	40-60	3	F 2 A
220	150	9-14	40-60	1,7	F 1 A

Characteristics of shunt trip coils, closing coils and opening coils for F-and V-module

Rated voltage (V)	Power consumption (W) or (VA)	Operation times		Peak start current (A)	Fuse for closing coil Y2 (Opening coil Y1 is unfused)
		Closing time (ms)	Opening time (ms)		
24 V DC	150	40-60	40-60	6	F 3,15 A
48 V DC	200	40-60	40-60	4	F 2 A
60 V DC	200	40-60	40-60	3	F 1,6 A
110 V DC	200	40-60	40-60	2	F 1 A
220 V DC	200	40-60	40-60	1	F 0,5 A
110 V AC	200	40-60	40-60	2	F 1 A
230 V AC	200	40-60	40-60	1	F 0,5 A

## 21 Motor operation

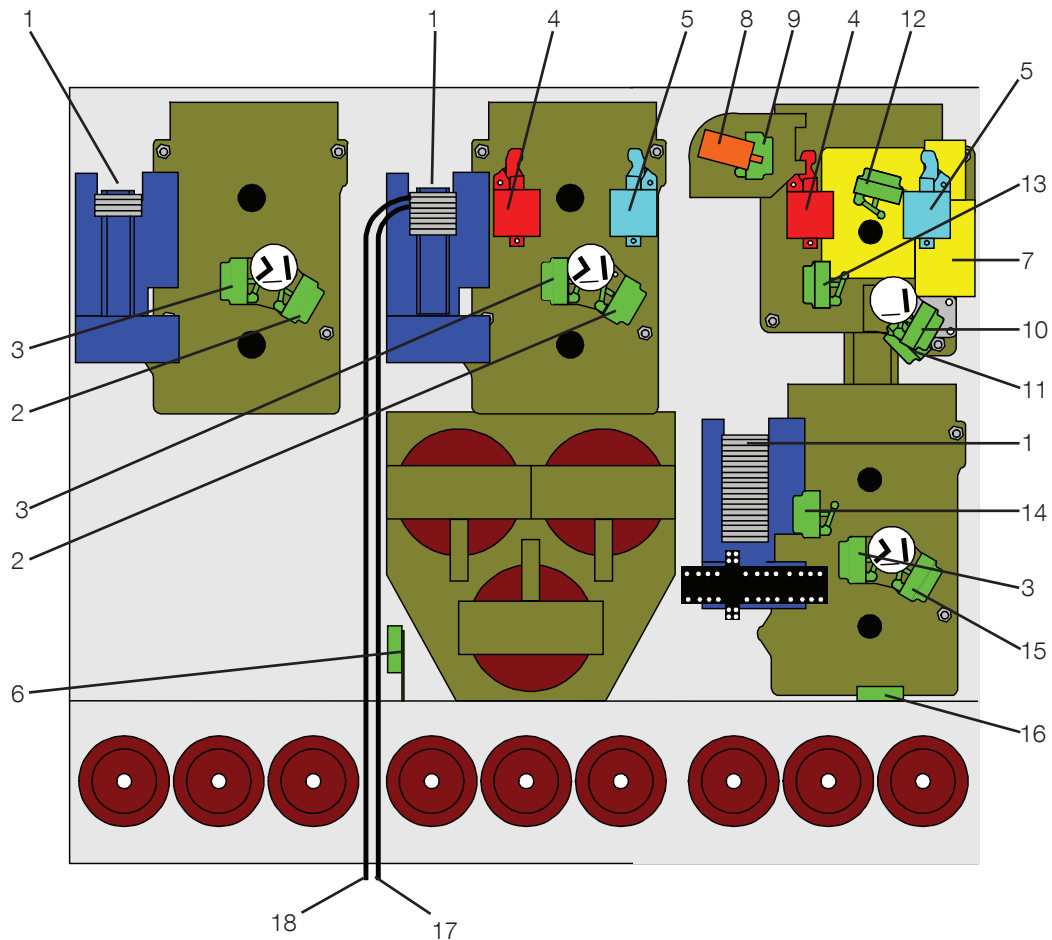

SafePlus consisting of CFV modules equipped with various auxiliary switches, coils and motor operation

1. Terminal blocks/control unit motor operation
2. Auxiliary switch S7, load break switch
3. Auxiliary switch S10, earthing switch
4. Opening coil Y1
5. Closing coil Y2
6. Auxiliary switch S9, fuse blown
7. Motor operation
8. Relay trip coil Y3 / Y4 / Y5 /Y6\*
9. Auxiliary switch S9, circuit breaker tripped signal
10. Auxiliary switch S5, circuit breaker
11. Auxiliary switch S6, mechanism latched
12. Auxiliary switch S8, spring charged
13. Auxiliary switch S14, operating handle, VCB
14. Auxiliary switch S15, operating handle, disconnecter
15. Auxiliary switch S7, disconnecter
16. Auxiliary switch S13, cable compartment cover
17. Auxiliary switch S20, arc suppressor
18. Auxiliary switch S19, SF6 gas pressure

\* Depending of the type of protection relay, the V module can only be delivered with one of the relay trip coils.

## 22 Transformer protection

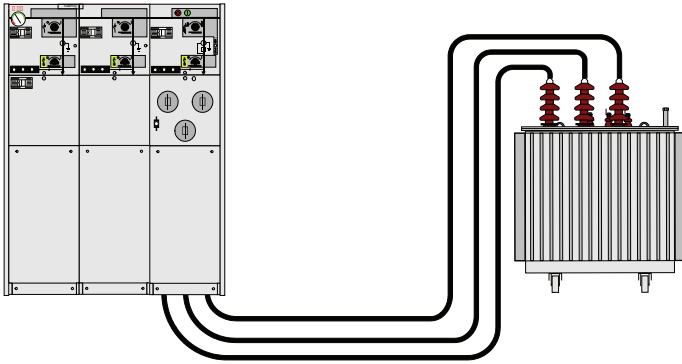

SafeRing and SafePlus offer a choice between a switch fuse combination and circuit-breaker in combination with relay for transformer protection.

The switch-fuse combination offers optimal protection against short-circuit currents, while the circuit-breaker with relay offers better protection against low over-currents. Circuit-breaker with relay is always recommended for higher rated transformers.

SafeRing is delivered with a 200 A rated V-module. SafePlus V- module has two options: 200 or 630 A rating.

Both for SafeRing and SafePlus the relay is a self-powered relay that utilizes the energy from the CTs under a fault situation to energize the trip coil.

The self-powered relay can also be used for cable protection. More details on the different relays can be found from page 75.

### Transformer protection with self-powered relay.

Recommended types:

- ABB relay type REJ603 r.1.5
- Woodward relays type WIC 1 and WIB 1 PE
- Kries relay type IKI-30

### Important features V-module:

- Relay behind cover. No need for additional low voltage box for the self-powered relays used for transformer protection.

### Typical for vacuum circuit-breaker protection:

- Good protection against short-circuits
- Very good for protection of over-currents
- Small fault currents are detected in an early stage

### SafeRing and SafePlus - Fuse-link selection

By selection of fuse-links for the protection of a transformer, it is important that requirements in IEC 62271-105 and in IEC 69787 are fulfilled. In particular, Annex A in IEC 62271-105 gives a good example of the coordination of fuse-links, switch and transformer.

Correct selection of fuse-links for the protection of the transformer will give:

- Optimal protection of the transformer
- No damage on the fuse-link's fuse-elements due to the magnetizing inrush current of the transformer
- No overheating of the fuse-links, the switch-fuse combination or the switchgear due to the full load current or the permissible periodic overload current of the transformer
- A transfer current of the combination which is as low as possible, and less than the rated transfer current of the switch-fuse combination
- A situation where the fuse-links alone will deal with the condition of a short-circuit on the transformer secondary terminals
- Fuse-links that discriminate with the low-voltage fuse-links in the event of phase-to-phase faults occurring downstream the low-voltage fuse-links

By carefully checking that these rules are followed, fuse-links from any manufacturer can be used in combination with SafeRing and SafePlus as long as the fuse-links are in accordance with the requirements described in the following pages.



## 23 Fuse-links

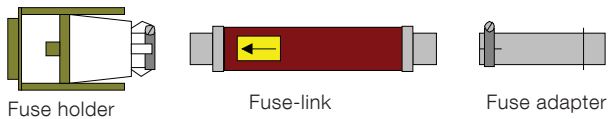

SafeRing and SafePlus are designed and tested for fuse-links according to IEC 60282-1

The dimensions of the fuse-links have to be in accordance with IEC 60282-1, Annex D. The fuse-links have to be type I with terminal diameter equal to  $45 \pm 1$  mm and body length (e) equal to 442 mm.

The dimensions of the fuse-links can also be in accordance with DIN 43625 and the length of the fuse canister is based on the use of fuse-links with length 442 mm. For installation of shorter fuses, (<24kV) a fuse adapter will be needed.

Please note: When inserting the fuse-link into the canister, the striker-pin must always face outwards against the fuse holder. The fuse adapter has to be fixed to the fuse-link contact that faces inward in the fuse canister.

The maximum size of distribution transformer which can be fed from a SafeRing / SafePlus switch-fuse module is 1600 kVA. For higher rated transformers, we recommend our vacuum circuit-breaker module with CT's and protection relay.

The below table shows CEF fuse-links for use in SafeRing/ SafePlus. For more technical data, refer to ABB Poland catalogue 3405PL202-W6-en.

In order to find the correct fuse-link compared to the transformer rating in kVA, please see the selection tables 23.1.1, 23.1.2 and 23.2.1

Type	Rated voltage kV	Rated current A	e / D mm	Type	Rated voltage kV	Rated current A	e / D mm
CEF	3,6/7,2	6	192/65	CEF	17,5	6	292/65
CEF	3,6/7,2	10	192/65	CEF	17,5	10	292/65
CEF	3,6/7,2	16	192/65	CEF	17,5	16	292/65
CEF	3,6/7,2	25	192/65	CEF	17,5	25	292/65
CEF	3,6/7,2	40	192/65	CEF	17,5	40	292/87
CEF	3,6/7,2	50	192/65	CEF	17,5	50	292/87
CEF	3,6/7,2	63	192/65	CEF	17,5	63	292/87
CEF	3,6/7,2	80	192/87	CEF	17,5	80	442/87
CEF	3,6/7,2	100	192/87	CEF	17,5	100	442/87
CEF	3,6/7,2	125	292/87				
CEF	3,6/7,2	160	292/87				
CEF	12	6	292/65	CEF	24	6	442/65
CEF	12	10	292/65	CEF	24	10	442/65
CEF	12	16	292/65	CEF	24	16	442/65
CEF	12	25	292/65	CEF	24	25	442/65
CEF	12	40	292/65	CEF	24	40	442/65
CEF	12	50	292/65	CEF	24	50	442/87
CEF	12	63	292/65	CEF	24	63	442/87
CEF	12	80	292/87				
CEF	12	100	292/87				
CEF	12	125	442/87				

## 23.1 Fuse selection table - CEF

Table 23.1.1

100%	Transformer rating (kVA)																Fuse-link rated voltage	
$U_n$ (kV)	25	50	75	100	125	160	200	250	315	400	500	630	800	1000	1250	1600		
3	16	25	25	40	40	50	50	80	100	125	160	160						7,2 kV
3,3	16	25	25	40	40	50	50	63	80	100	125	160						
4,15	10	16	25	25	40	40	50	50	63	80	100	125	160					
5	10	16	25	25	25	40	40	50	50	63	80	100	160	160				
5,5	6	16	16	25	25	25	40	50	50	63	80	100	125	160				
6	6	16	16	25	25	25	40	40	50	50	80	100	125	160	160			
6,6	6	16	16	25	25	25	40	40	50	50	63	80	100	125	160			
10	6	10	10	16	16	25	25	25	40	40	50	50	80	80	125	125		12 kV
11	6	6	10	16	16	25	25	25	25	40	50	50	63	80	100	125		
12	6	6	10	16	16	16	25	25	25	40	40	50	63	80	100	125		
13,8	6	6	10	10	16	16	25	25	25	25	40	50	50	63	80	100		17,5 kV
15	6	6	10	10	16	16	16	25	25	25	40	40	50	63	80	100		
17,5	6	6	6	10	10	16	16	16	25	25	25	40	50	50	63	80		
20	6	6	6	10	10	16	16	16	25	25	25	40	40	50	63	63		24 kV
22	6	6	6	6	10	10	16	16	16	25	25	25	40	50	50	63		
24	6	6	6	6	10	10	16	16	16	25	25	25	40	40	50	63		

- The table is based on using fuses type ABB CEF
- Normal operating conditions with no overload
- Ambient temperature -25°C - +40°C

Table 23.1.2

120%	Transformer rating (kVA)																Fuse-link rated voltage	
$U_n$ (kV)	25	50	75	100	125	160	200	250	315	400	500	630	800	1000	1250	1600		
3	16	25	25	40	40	50	63	80	100	125	160							7,2 kV
3,3	16	25	25	40	40	50	63	80	80	100	125							
4,15	10	16	25	25	40	40	50	63	80	80	100	125						
5	10	16	25	25	25	40	40	50	63	80	80	125	160					
5,5	6	16	16	25	25	25	40	50	50	80	80	100	125	160				
6	6	16	16	25	25	25	40	40	50	63	80	100	125	160				
6,6	6	16	16	25	25	25	40	40	50	63	80	80	100	125				
10	6	10	10	16	16	25	25	25	40	40	50	63	80	80	125			12 kV
11	6	6	10	16	16	25	25	25	25	40	50	50	80	80	100	125		
12	6	6	10	16	16	16	25	25	25	40	40	50	63	80	100	125		
13,8	6	6	10	10	16	16	25	25	25	25	40	50	50	80	80	100		17,5 kV
15	6	6	10	10	16	16	16	25	25	25	40	40	50	63	80	100		
17,5	6	6	6	10	10	16	16	16	25	25	25	40	50	50	63	80		
20	6	6	6	10	10	16	16	16	25	25	25	40	40	50	63	80		24 kV
22	6	6	6	6	10	10	16	16	16	25	25	25	40	50	50	63		
24	6	6	6	6	10	10	16	16	16	25	25	25	40	40	50	63		

- The table is based on using fuses type ABB CEF
- Normal operating conditions with 20% overload
- Ambient temperature -25°C - +40°C

## 23.2 Fuse selection table - CEF-S

Table 23.2.1

Transformer rated voltage (kV)	Transformer rating (kVA)												Fuse-link rated voltage (kV)	Fuse-link length „e“ (mm)	Catalogue No. CEF-S	Catalogue No. CEF-S-TCU
	25	50	75	100	125	160	200	250	315	400	500	630				
	Fuse-link rating In (A)															
3	16	25	40	50									6/12	292	10A:1YMB531011M0001 16A:1YMB531011M0002 20A:1YMB531011M0003 25A:1YMB531011M0004 40A:1YMB531011M0005 50A:1YMB531011M0006	10A:1YMB531861M0001 16A:1YMB531861M0002 20A:1YMB531861M0003 25A:1YMB531861M0004 40A:1YMB531861M0005 50A:1YMB531861M0006
3.3	16	25	40	50	50											
4.15	16	20	40	40	50											
5	10	20	25	40	40	50										
5.5	10	20	20	40	40	40	50									
6	10	16	20	25	40	40	50									
6.6	10*	16	20	25	40	40	50	50								
10	10*	10	16	20	20	25	40	40	50							
11	10*	10	16	20	20	25	40	40	40	50						
12	10*	10	16	16	20	20	25	40	40	50						
13.8	10*	10*	16	16	16	20	20	40	40	40						
15	10*	10*	10	16	16	20	20	25	40	40						
17.5	10*	10*	10	16	16	20	20	20	40	40	40	10/24				
20	10*	10*	10*	10	16	16	20	20	25	40	40					
22	10*	10*	10*	10	16	16	20	20	20	40	40		40			
24	10*	10*	10*	10	16	16	16	20	20	25	40		40			
Max.gG fuse-link at LV side (A)	40	80	125	160	160	200	250	250	300	400	400		800			

The table was calculated according to standards IEC 60787 and IEC 62271-105. The following transformer and switch-gear work conditions were assumed:

- Maximum long-lasting transformer overload - 120%,
- Magnetizing inrush current for transformers up and including 630kVA - 12 x In during 100ms,
- Magnetizing inrush current for transformers above 630kVA - 10 x In during 100ms,
- Standard ambient working conditions for SafeRing/SafePlus switchgear (most important: ambient temperature -25 °C to +40 °C),

For ratings marked with “\*” transformer maximum short-circuit current at LV side, transferred to HV side, is below fuse-link minimum breaking current I3.

The table above details the rated current of a particular fuse-link for a given line voltage and transformer rating. For different criteria, the fuse selection must be recalculated.

## 24 Relays



SafePlus can be delivered with a V-module with 630A vacuum circuit-breaker. This chapter describes the different choices of protection relays and feeder terminals that can be used in SafePlus. These relays require an additional low voltage compartment.

For transformer protection with maximum 200A vacuum circuit-breaker see chapter 22, "Transformer protection".

Standard test procedure is functional test of trip circuit of the relays. All customer settings must be done on site.

REF type feeder terminals are configured according to customer specification for protection functions. Special control requirements on request only.

The V-module can also be delivered prepared for protection relays.

This is defined in two types:

- Trip coil and auxiliary contact.
- Cut out in LV-compartment, trip coil, aux contact, wiring and drawings.

There are three main groups of relays delivered:

- A. ABB feeder protection relays
- B. Self-powered relays
- C. ABB feeder terminals type REF 54x

A. ABB offers a wide range of feeder protection relays.

These relays have been sold for a long period and have an excellent reputation for reliability and secure operation. These relays have either 18-80VDC or 80-265VAC/DC auxiliary supplies and are connected to conventional CTs and VTs.

B. Self-powered relays are suitable for rough conditions and places without the possibility of auxiliary supply.

SafeRing and SafePlus can be delivered with different types to fulfil all relevant needs in a distribution network.

C. ABB feeder terminals, type REF 54x provide cost-effective solutions for different protection, monitoring and control applications. The terminals enable the use of accurate and reliable current and voltage sensors as well as conventional CTs and VTs.

## 24 Relays



### Feeder protection

The power protection applications can be roughly divided into two categories, namely standard applications (utilizing basic current based protection) and high requirement applications (utilizing current and voltage based protection) and also the combination of the two.

The selected power protection scheme or system has to fulfil the application-specific requirements regarding sensitivity, selectivity and operating speed of the power protection. The power protection requirements are mainly determined by the physical structure of the power network or system and in most cases the requirements can be fulfilled with non-directional/directional over-current protection IEDs. In power networks or systems with a more complex structure, more advanced power protection functions like distance protection or line differential protection may have to be introduced.

The purpose of the over- and under-voltage power protection system is to monitor the voltage level of the network. If the voltage level deviates from the target value by more than the permitted margin for a set time period, the voltage protection system is activated and it initiates actions to limit the duration of this abnormal condition and the resulting stresses caused to the power system or its components.

To prevent major outages due to frequency disturbances, the substations are usually equipped with under-frequency protection IEDs, which in turn control various power load-shedding schemes. These are just a few examples of the protection for power feeders provided by ABB relays.

### Powered Relays

For features and functions, see table at page 79.

### REF601

REF601 is a dedicated feeder protection relay, intended for the protection of utility substations and industrial power systems, in primary and secondary distribution networks. REF601/REJ601 is a member of ABB's Relion® product family and part of its 601 series. The relay is available in three alternative application configurations: A, B and C.

### REC615

REC615 is a dedicated grid automation IED designed for remote control and monitoring, protection, fault indication, power quality analyzing and automation in medium-voltage secondary distribution systems, including networks with distributed power generation and with secondary equipment such as medium-voltage disconnectors, switches and ring main units.



## 24 Relays



### REF611

REF611 is a dedicated feeder IED designed for the protection, control, measurement and supervision of utility substations and industrial power systems including radial, looped and meshed distribution networks with or without distributed power generation. REF611 is available in two alternative standard configurations.

### REF615

REF615 is a dedicated feeder IED perfectly aligned for the protection, control, measurement and supervision of utility and industrial power distribution systems. It mainly provides protection for overhead lines, cable feeders and busbar systems of power distribution substations. It fits both isolated neutral networks and power networks with resistance or impedance earthed.

### REF620

REF620 is a dedicated feeder IED perfectly aligned for the protection, control, measurement and supervision of utility and industrial power distribution systems, including radial, looped and meshed distribution networks. REF620 is a member of ABB's Relion® protection and control product family and its 620 series. The 620 series IEDs are characterized by their functional scalability and withdrawable-unit design. The 620 series has been designed to unleash the full potential of the IEC 61850 standard for communication and inter-operability of substation automation devices.

### REF630

REF630 is a comprehensive feeder management IED for protection, control, measuring and supervision of utility and industrial distribution substations. REF630 is a member of ABB's Relion® product family and a part its 630 product series characterized by functional scalability and flexible configurability.

REF630 also features necessary control functions constituting an ideal solution for feeder bay control. REF630 provides main protection for overhead lines and cable feeders of distribution networks. REF630 fits both isolated neutral networks and networks with resistance or impedance earthed neutral. Four pre-defined configurations to match typical feeder protection and control requirements are available.

The pre-defined configurations can be used as such or easily adapted or extended with freely selectable add-on functions, by means of which the IED can be fine-tuned to exactly satisfy the specific requirements of your present application. REF630 incorporates local and remote control functions. The IED offers a number of freely assignable binary inputs/outputs and logic circuits for establishing bay control and interlocking functions for circuit breakers and motor operated switch-disconnectors. REF630 supports both single and double busbar substation busbar layouts.

## 24 Relays

For full overview of protection relay functionality refer to the data sheet of the specific relay.

Technical functions powered relays	Powered relays							
	IEC61850	IEC60617	IEEE device no.	REF601	REF611	REF615	REF620	REF630
<b>Functionality groups</b>								
<b>Overcurrent functions</b>								
Three-phase transformer inrush detector	INROPHARI	3I2f>	68	X	X	X	X	X
Three-phase non-directional overcurrent protection, low stage	PHLPTOC	I>	51P-1	X	X	X	X	X
Three-phase non-directional overcurrent protection, high stage	PHHPTOC	I>>	51P-2	X	X	X	X	X
Three-phase non-directional overcurrent protection, instantaneous stage	PHIPTOC	I>>>	50P/51P	X	X	X	X	X
Three-phase directional overcurrent protection, low stage	DPHLPTOC	I>->	67-1			X	X	X
Three-phase directional overcurrent protection, high stage	DPHHPTOC	I>>->	67-2			X	X	X
<b>Earth-fault functions</b>								
Non-directional earth-fault protection, low stage	EFLPTOC	Io>	51N-1	X	X	X	X	X
Non-directional earth-fault protection, high stage	EFHPTOC	Io>>	51N-2	X	X	X	X	X
Non-directional earth-fault protection, instantaneous stage	EFIPTOC	Io>>>	50N/51N			X	X	X
Directional earth-fault protection, low stage	DEFLPDEF	Io>->	67-N1			X	X	X
Directional earth-fault protection, high stage	DEFHPDEF	Io>>->	67N-2			X	X	X
<b>Over-/undervoltage</b>								
Three-phase overvoltage protection	PHPTOV	U>/>>/>>>	59			X	X	X
Three-phase undervoltage protection	PHPTUV	U</<</<<<	27			X	X	X
Residual overvoltage protection	ROVPTOV	Uo>	59G		X	X	X	X
<b>Frequency protection function</b>								
	FRPFRQ	f>/f<,df/dt	81			X	X	X
<b>Thermal protection function</b>								
Three-phase thermal protection	T1PTTR	3Ith>F	49F	X	X	X	X	X
<b>Arc protection function</b>								
Arc protection	ARCSARC	ARC	50L/50NL			X	X	
<b>Advanced protection functions</b>								
Auto-reclosing	DARREC	O -> I	79	X	X	X	X	X
Fault locator	SCEFRFLO	FLOC	21FL			X		X
Distance protection	DSTPDIS	Z<	21,21P,21N					X
Synchro check	SYNCRSYN	SYNC	25			X	X	X
<b>Measuring functions</b>								
Three-phase current measurement	CMMXU	3I	3I		X	X	X	X
Voltage	VMMXU	3U	3V			X	X	X
Power and energy measurement (S,P,Q,PF)	PEMMXU	P,E	P,E			X	X	X
Frequency	FMMXU	f	f			X	X	X
Disturbance recorder	RDRE	DR	DFR		X	X	X	X
Residual current measurement	RESCMMXU	Io	In		X	X	X	X
Residual voltage measurement	RESVMMXU	Uo	Vn		X	X	X	X
Load profile recorder	LDPMSTA	LOADPROF	LOADPROF			X	X	
<b>Communication functions</b>								
103				X		X	X	X
IEC61850					X	X	X	X
Modbus				X	X	X	X	

## 24 Relays



### Self-powered relays

#### REJ603 r.1.5

REJ603 r.1.5 relay is intended to be used for the selective short-circuit and earth-fault protection of feeders in secondary distribution networks and for protection of transformers in utilities and industries. This relay has dual mode of earth-fault measurement - internal vector summation or external CBCT input. Functions are easy to set up by using the dip-switches.



#### IKI30

The Trafomonitor IKI-30 is applicable for monitoring and protection of distribution network transformers between 160 kVA and 12 000 kVA. By means of split-core CTs, overcurrents and short-circuit currents can be detected in the lines.

Applications:

- Overcurrent- and short circuit/earth-fault protection by combination of IKI-30 and circuit breaker / load breaker
- Overcurrent protection by combination of IKI-30 with load breaker and high voltage fuses.



#### WIB1

All available versions of the WIB1 relay are a high-tech and cost-optimized protection for MV switchboards. Specifically in compact switchboards, the WIB12PE and WIB12FE protection system in combination with a circuit breaker can replace the combination of load-break-switch with HV fuses. The overload protection for the attached unit is clearly improved. When power distribution networks are extended more and more high powered transformers are used and HV fuses are inadmissible. For such applications the WIB1 protection system is an optimal replacement.

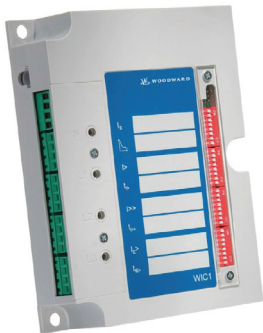

#### WIC1

All available versions of the WIC1 relay are a high-tech and cost-optimized protection for MV switchboards. Specifically in compact switchboards, the WIC1 protection system in combination with a circuit breaker can replace the combination of load break switch with HV fuses. The overload protection for the attached unit is clearly improved. When power distribution networks are extended more and more high powered transformers are used and HV fuses are inadmissible. For such applications the WIC1 protection system is an optimal replacement.



#### WIP1

The WIP1 is an overcurrent relay with multi-characteristics. Definite time and inverse time tripping characteristics can be selected. The WIP1-1 does not require any auxiliary voltage supply, consequently it can also be used for switchboards without built-in batteries. It takes its power supply energy from the current transformers' circuits and provides the tripping pulse energy to the circuit breaker. Due to its wide setting ranges, the tripping characteristic can be selected to protect a wide variety of different equipment. Optionally the WIP1 is available with earth fault element (option IE) and negative sequence element (option IS).



# 24 Relays

## Technical functions self-powered relays

Functionality				Relay				
Features	Description	IEC 60617	IEEE device no.	WIP 1	REJ603 r.1.5	WIC 1	WIB 1	IKI 30
Protection functions	Three-phase transformer inrush detector	3I2f>	68	-	X	-	-	X
	Phase overcurrent (multi-characteristic)	3I> (low set)	50/51	X	X	X	X	X
	Short-circuit protection	I>>	50/51	X	X	X	X	X
	Number of overcurrent elements		50/51B	2	2	2	2	2
	Earth-fault current	I0> (low set)	50N/51N	X	X	X	X	X
	Number of earth-fault elements			2	2	1	2	2
Characteristic curves	Overcurrent element			DEFT,INV <sup>1)</sup>	DEFT,INV <sup>1)</sup>	DEFT,INV <sup>1)</sup>	DEFT	DEFT,INV <sup>1)</sup>
	Earth-fault current			DEFT,INV <sup>1)</sup>	DEFT,INV <sup>1)</sup>	DEFT	DEFT,INV <sup>1)</sup>	DEFT
Additional functions	Trip indication			X	X	X (option)	X	X
	Electro-impulse			1	1	1	2	1
	input remote tripping (voltage)			230VAC	-	115/230VAC	115/230VAC	24VDC/ 115/230VAC
	Auxiliary power, voltage (option)							
Measuring circuit	Rated secondary current			ring core CT with I <sub>sec</sub> = 1A	wide range special CT	wide range special CT	wide range special CT	wide range special CT
	Measuring range, start current I <sub>&gt;</sub> (A)			0,17 <sup>3)</sup>	7,2	7,2	7,2	7,2
Climatic withstand	Storage temperature (°C)			-40 ...+85	-40 ...+85	-40 ...+85	-40 ...+85	-30 ...+70
	Operating temperature (°C)			-20 ...+55	-40 ...+85	-40 ...+85	-40 ...+85	-25 ...+55

<sup>1)</sup> - Definite time overcurrent (DEFT)  
 - Normal inverse time overcurrent (NINV)  
 - Very inverse time overcurrent (VINV)  
 - Extremely inverse time overcurrent (EINV)  
 - Long time inverse time overcurrent (LINV)

- Resistance inverse time overcurrent (RINV)  
 - Characteristics of high voltage fuse-link (HV-FUSE)  
 - Characteristics of full range fuse (FR-FUSE)  
 - Definite time overcurrent  
 - Inverse characteristics, please contact us for further information

<sup>3)</sup> secondary current

## 24 Relays

### Ring core current transformers and earth-fault transformers

REJ603 r.1.5 transformer protection and cable protection kit (self-powered)	Ring core current transformer type	Current range
Transformer type	KOKM 072 CT1	8 - 28 A
Transformer type	KOKM 072 CT2	16 - 56 A
Transformer type	KOKM 072 CT3	32 - 112 A
Transformer type	KOKM 072 CT4	64 - 224 A
Transformer type	KOKM 072 CT5	128 - 448 A
WIB1 transformer protection and cable protection kit (self-powered)	Ring core current transformer type	Current range
Transformer type	KOKM 072 CT2 or WIC1-W2	16 - 56 A
Transformer type	KOKM 072 CT3 or WIC1-W3	32 - 112 A
Transformer type	KOKM 072 CT4 or WIC1-W4	64 - 224 A
Transformer type	KOKM 072 CT5 or WIC1-W5	128 - 448 A

## 25 Capacitive voltage indicators



VPIS



HR-module (VDS)



VIM 3



VIM 1

SafeRing/SafePlus switchgears are equipped with voltage indicators in accordance either with IEC 61958 standard for voltage presence indication system (VPIS) or IEC 61243-5 standard for voltage detection system (VDS).

### Voltage indicators VPIS

VPIS indicators indicate only presence of the medium voltage. Absence of the voltage needs to be confirmed by use of voltage detection equipment.

### Phase comparison and testing of VPIS

Each phase of the integrated voltage presence indicating system has a connection point on the front panel, which can be used to perform phase comparison and to test the voltage presence indicator.

### Voltage indicators VDS

VDS is used to detect the presence or absence of medium voltage according to IEC 61243-5.

The VDS system delivered by ABB can be either based on the LRM or the HR- system.

### Voltage indicators VDS LRM

With the VDS LRM system, the following can be indicated:

- Overvoltage
  - Nominal voltage presence
  - Isolation problems
  - No voltage
  - Broken lead indication (Optional feature)
- Indication is done visually on the display.

### Voltage indicators VDS HR

SafeRing / SafePlus can be delivered with a Voltage Detection System, VDS HR, according to IEC 61243-5.

The indicator itself consists of two parts: a fixed part assembled at the switchgear and portable indicator lamps, type VIM-1 and VIM-3, which can be connected to the coupling system interface.

### Phase comparator

Phase comparator is used for controlling the phase sequence when connecting two voltage systems together, e.g during the switching from one source of power supply to another. Phase comparison can be done by any phase comparator according to IEC 61243-5.

## 25 Capacitive voltage indicators

### Technical functions capacitive voltage indicators

Manufacturer	Maxeta	Anda	Maxeta	Horstmann	Horstmann	Horstmann	Kries	Kries
Model	VPIS	DNX5	HR module	WEGA 1.2C (45 deg)	WEGA 2.2C (45 deg)	WEGA 1.2C Vario	Capdis S1+(R4)	Capdis S2+(R4)
Type	VPIS	VPIS	VDS	VDS	VDS	VDS	VDS	VDS
Standard	62271-206	62271-206	61243-5	61243-5	61243-5	61243-5	61243-5	61243-5
Capacity variable sec.	no	no	no	no	no	yes	yes	yes
Voltage range	9-15kV 15-24kV	3-6kV 6-12kV 12-24kV 24-40,5kV	6-12kV 12-24kV	3-6kV 6-12kV 10-24kV	3-6kV 6-12kV 10-24kV	Adjustable	Adjustable	Adjustable
Signalling contacts	no	no	no	yes * (1)	yes * (2)	yes *	no	yes *
Self testing	external	no	external	internal	internal	internal	internal	internal
Phase comparison	yes	yes	yes	yes	yes	yes	yes	yes
Indicating lamps	yes	yes	Yes (external VIM-1 or VIM-3)	internal	internal	internal	internal	internal
Resistivity tape	-	-	HR	LRM	LRM	LRM	LRM	LRM
Link up to FPI	no	no	no	Compass B, Sigma D, Sigma D+	Compass B, Sigma D, Sigma D+	-	-	IKI 50
Way of indication	Led lamps	Led lamps	Led lamps (external)	Display, symbols	Display, symbols	Display, symbols	Display, symbols	Display, symbols
External source for testing	no	no	no	no	no	no	no	no
Broken signal leash detection	no	no	no	no	no	no	yes	yes

\* For signalling contact, auxiliary voltage is required

## 26 Short-circuit and earth-fault indicators



The increasing demand for reliability and effectiveness of distribution networks requires higher flexibility and more automated ring main units.

As one of the biggest player in the medium voltage distribution segment, ABB replies to this demand by installation of grid automation devices. One of the basic devices is fault passage indicator.

### Fault passage indicators

A fault passage indicator may be delivered as an option to the SafeRing/SafePlus switchgear. The indicator is usually placed in the front panel of the switchgear. It makes it possible to detect any faults, including short circuits, earth-faults and short current direction, and makes it easier to locate any fault.

A fault passage indicator offers different functionalities to the customers, either short circuit indication which is designed to detect, display and remotely indicate short-circuits in medium voltage distribution networks, or earth-fault indication which is designed to detect, locally indicate and remotely report earth-fault currents in medium voltage distribution networks.

Both functionalities can be combined in one device.

# 26 Short-circuit and earth-fault indicators

Technical functions capacitive voltage indicators

Manufacturer	Horstmann	Horstmann	Horstmann	Horstmann	Horstmann	Horstmann	Horstmann	Horstmann	Kries	Kries	Kries	Kries	Kries	Kries	Kries	Anda
Model	Sigma	Sigma F+E3	Sigma D	Sigma D+	Compass B	Compass B	Compass B	Compass B	IKI-50	IKI-50-PULS-EV	IKI-20	IKI-20PULS	IKI-20C	IKI-20C	IKI-20C	Anda
Dedicated volt.ind.	-	-	Wega 1.2C/ Wega 1.2 Wega 2.2C	Wega 1.2C/ Wega 1.2 Wega 2.2C	Wega 1.2C/ Wega 1.2 Wega 2.2C	Wega 1.2C/ Wega 1.2 Wega 2.2C	Wega 1.2C/ Wega 1.2 Wega 2.2C	Wega 1.2C/ Wega 1.2 Wega 2.2C	Capdis S1/ S2-R4	Capdis S1/ S2-R4	Capdis S1/ S2-R4	Capdis S1/ S2-R4	Capdis S1/ S2-R4	Capdis S1/ S2-R4	Capdis S1	EKL-7
STC fault ind.	X	X	X	X	X	X	X	X	X	X	X	X	X	X	X	X
Directional ind.	-	-	-	-	-	-	-	-	-	-	-	-	-	-	-	-
Directly earthed neutral	-	X	X	X	X	X	X	X	X	X	X	X	X	X	X	X
Isolated neutral -	-	-	-	-	-	-	-	-	-	-	-	-	-	-	-	-
Wattmetric (sin)	-	-	-	-	-	-	-	-	-	-	-	-	-	-	-	-
Compensated neutral -	-	-	-	-	-	-	-	-	-	-	-	-	-	-	-	-
Wattmetric (cos)	-	-	-	-	-	-	-	-	-	-	-	-	-	-	-	-
Compensated neutral -	-	-	-	-	-	-	-	-	-	-	-	-	-	-	-	-
transient	-	-	-	-	-	-	-	-	-	-	-	-	-	-	-	-
Compensated neutral -	-	-	-	-	-	-	-	-	-	-	-	-	-	-	-	-
puls	-	-	-	-	-	-	-	-	-	-	-	-	-	-	-	-
Monitoring	X	X	X	X	X	X	X	X	X	X	X	X	X	X	X	X
Trip current short-circuit	100-1000A	200-2000A	50-2000A	50-2000A	50-2000A	50-2000A	50-2000A	50-2000A	100-1000A	100-1000A	100-2000A	100-2000A	400-1000A	400-1000A	100-2000A	400.600.800, 1000A
Response time short-circuit	40-80ms	40/60/200/300ms	40ms-60s	40ms-60s	40ms-60s	40ms-60s	40ms-60s	40ms-60s	60-1600ms	60-1600ms	60-200ms	60-200ms	100ms	100ms	60-200ms	40, 60, 80, 100ms
Trip current earth-fault	-	20-160A	20-1000A	20-1000A	20-1000A	20-1000A	20-1000A	20-1000A	40-200A + 4-30A (cosphi methode) + transient methode	40-200A + 4-30A (cosphi methode) + transient methode	40-200A	40-150A	400-1000A	400-200A	20, 40, 60, 80A	
Response time earth-fault	-	60/80/200/300ms	40ms-60s	40ms-60s	40ms-60s	40ms-60s	40ms-60s	40ms-60s	60-1600ms	60-1600ms	60-200ms	Appr. 9s after detecting pulsating current	100ms	100ms	60-200ms	80, 120, 160, 200ms
Remote test/reset	X	X	X	X	X	X	X	X	X	X	X	X	X	X	X	X
Automatic reset time	1,2,4,8 h	2,4,8,24h	1 min - 24h	1 min - 24h	1 min - 24h	1 min - 24h	1 min - 24h	1 min - 24h	1,8h or automatic after load current is recovered	1,8h or automatic after load current is recovered	2,4h	2,4h	2,4h	2,4h	2,4h	1,2,4,8h
Supply	Long life lithium cell	Long life lithium cell	CT powered	CT powered, aux.supply possible: 24V AC, 24-60V DC	24-230V AC/DC (ext)	24-230V AC/DC (ext)	24-230V AC/DC (ext)	24-230V AC/DC (ext)	24-230V AC/DC	24-230V AC/DC	3 options: Aux.( ext), capacitor buffered, battery, dep. on version	2 options: Aux.( ext), capacitor buffered, dep. on version	Self-powered + capacitor	Self-powered + capacitor	24-230V AC/DC, ony for sensitive earth-fault function + battery	230V AC/DC (ext), 3,6V battery (int)
Life time of battery	20 years (batteries)	20 years (batteries)	20 years (batteries)	20 years (batteries)	20 years (batteries)	20 years (batteries)	20 years (batteries)	20 years (batteries)	-	-	17* years	12 h for cap. buffering	4 h for capacitor	4 h for capacitor	15 years (batteries)	10 years (batteries)
No. of relay contacts	1	3	4	4	4	4	4	4	4	4	1-3 dep. on version	2 dep. on version	2	2	1-3	2
Comm. protocole	-	-	-	-	-	-	-	-	Modbus	Modbus	Modbus	Modbus	Modbus	Modbus	-	-
Configuration	DIP	DIP	DIP/SW	DIP/SW	Menu/SW	Menu/SW	Menu/SW	Menu/SW	Modbus Menu nav.	Modbus Menu nav.	Modbus Menu nav.	Modbus	DIP	DIP	DIP	DIP

## 27 Manometers/Pressure indicators

SafeRing and SafePlus are sealed systems, designed and tested according to IEC 62271-200 as maintenance free switchgear for lifetime (30 years). The switchgear does not require any gas handling.

ABB applies state of the art technology for gas tightness providing the equipment with an expected leakage rate lower than 0.1 % per annum, referring to the filling-pressure of 1.4 bar\*. The switchgear will maintain gas-tightness and a gas-pressure better than 1.35 bar\* throughout its designed lifespan. This pressure value is still within a good margin from pressure used during the type tests, which is 1.3 bar\*.

\* at 20°C.

For increasing the safety under operation of the switchgear, manometers may be used for each tank.





In case of need of remote indication, manometers can be equipped with signalling contacts. Detailed descriptions of manometers functions are described in the table on next page.

### Altitude

Max height above sea level for installation without reducing gas pressure is 1500 meters. In the interval from 1500 to 2000 meters, gas pressure has to be reduced. For installation above 2000 meters, please contact ABB for instructions.



## 27 Manometers/Pressure indicators

Producer	Model	Insulation medium	Temp. compensation	Accuracy	Scale range (Absolute)	Appearance (Absolute)	Marking of scale (Absolute)	Over-pressure ind.	Signalling contact	Threshold pressure	Connection to the tank
 Wika with signal contact	Project specific ordering	SF6	X	+/- 1% (20 deg.)	0 ... 2 bar	red zone 0...1,2 bar green zone 1,2 bar...	mark at 1,2 bar	-	1x NO/NC	1,2 bar	solid
 Wika with signal contact	2RAA017583P0001	SF6	X	+/- 1% (20 deg.)	0 ... 2,2 bar	red zone 0...1,2 bar green zone 1,2 bar...	mark at 1,2 bar	-	1x NC	1,2 bar	solid
 Wika	NHP 304769P0001	SF6	X	+/- 1% (20 deg.) +/- 2,5% (-20...+60 deg.)	1 ... 2 bar	red zone 1,0...1,2 bar green zone 1,2...2,0 bar	mark at 1,4 bar	-	-	-	solid
 Wika with overpressure indicator	2RAA014075P0001	SF6	X	+/- 1% (20 deg.) +/- 2,5% (-20...+60 deg.)	1 ... 2 bar	red zone 1,0...1,2 bar green zone 1,2...2,0 bar	mark at 1,4 bar	X (yellow indication)	-	-	solid
 Elektron-system	Density switch GMD1	SF6	X	+/- 2% (-25...+70 deg.)	-	-	-	-	X	1,15/1,25 bar	solid



## 28 Key interlock

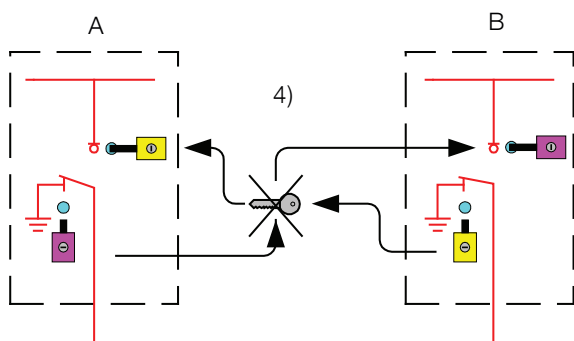
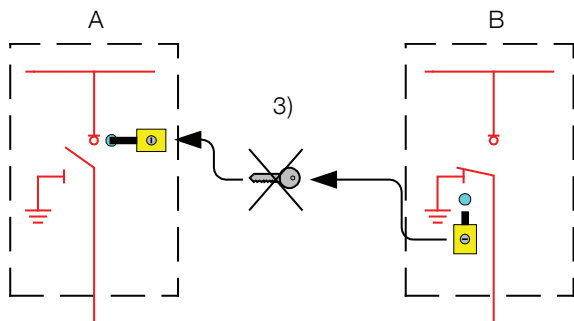
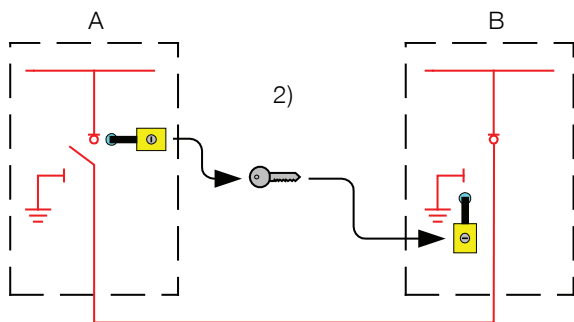
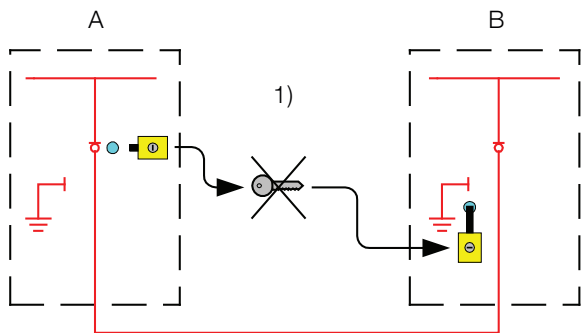

Available key locks are: Ronis, Castell, Kirk and STI. Ronis is default and recommended by ABB. For features, see table on next page.

Except for fuse-switch and vacuum circuit-breaker, all load break switches, earthing switches and disconnectors may be equipped with any single key interlock. For double key lock, Ronis is the only type that fits SafeRing/SafePlus switchgears.

### Example for single key interlock

Key interlocks can be used as follow: Two switchgears A and B are connected to each other by cables. The purpose of interlocks is to prevent closing of the earthing switch unless the load break switch in the other switchgear is locked in open position.

1) One key interlock will be mounted close to the operating shaft of the load break switch in switchgear A. An identical key interlock will be mounted close to the operating shaft of the earthing switch in switchgear B. As long as the load break switch in switchgear A is in closed position, it will be impossible to remove or operate the key in the key interlock.

2) First you have to operate the load break switch in switchgear A to open position. Then it will be possible to operate the key interlock and turn the key which extends the locking bolt. This will prevent access to the operating shaft of the load break switch. Then withdraw the key and insert it into the identical key interlock on the earthing switch of switchgear B.

3) When the key is inserted, you will be able to operate the key interlock and turn the key which will withdraw the extended locking bolt.

Then there will be access to operate the earthing switch to closed position. As long as the earthing switch is in closed position, the key will be captured, making it impossible to close the load break switch in switchgear A.

4) If the load break switch in switchgear B and earthing switch in switchgear A are equipped with another identical key interlock which has a different key combination than described above, it will be impossible to make an earth connection of an incoming energized cable from neither switchgear A nor B.

Another example for use of key interlocks is to prevent access to the distribution transformer before the primary side of the transformer is connected to earth. This can be solved by means of two identical key interlocks: one mounted on the earthing switch for the distribution transformer feeder and the other one on the door in front of the transformer.

## 28 Key interlock

### Types and features of locks

C/SI-module							
Type	LBS off	LBS on	LBS on/off	ES off single key	ES on	ES on/off	Doorlock
Ronis	X	X	X	X	X	X	N/A
Castell	X	X	N/A	X	X	N/A	N/A
Kirk	X	X	N/A	X	X	N/A	N/A
STI	X	X	N/A	X	X	N/A	N/A
F-module							
Type							
Ronis	N/A	N/A	N/A	X	X	X	N/A
Castell	N/A	N/A	N/A	X	X	N/A	N/A
Kirk	N/A	N/A	N/A	X	X	N/A	N/A
STI	N/A	N/A	N/A	X	X	N/A	N/A
V / V20 / V25 / Sv / Sv20 / Sv25-module							
Type	DS off	DS on	DS on/off double				
Ronis	X	X	X	X	X	X	N/A
Castell	X	X	N/A	X	X	N/A	N/A
Kirk	X	X	N/A	X	X	N/A	N/A
STI	X	X	N/A	X	X	N/A	N/A
De/Be-module							
Type							
Ronis	N/A	N/A	N/A	X	X	X	N/A
Castell	N/A	N/A	N/A	X	X	N/A	N/A
Kirk	N/A	N/A	N/A	X	X	N/A	N/A
STI	N/A	N/A	N/A	X	X	N/A	N/A
M-module *)							
Type							
Ronis	N/A	N/A	N/A	N/A	N/A	N/A	X
Castell	N/A	N/A	N/A	N/A	N/A	N/A	X
Kirk	N/A	N/A	N/A	N/A	N/A	N/A	X
STI	N/A	N/A	N/A	N/A	N/A	N/A	X

### Note:

None of the key lock functions in the table above are available for CB-module. This module has integrated key locks on all push buttons.

\*) For M-module, use of an exchange box needs to be considered

## 29 Smart Grid applications



### SafeRing/SafePlus for Smart Grid applications

12-24 kV SafeRing/SafePlus ring main unit portfolio from ABB is enhanced to meet the increasing demand for Smart Grid applications in secondary distribution networks.

Standard grid automation devices for ABB's ring main units are located in the space behind the lower front cover in the C-modules, hence eliminating the need for additional low voltage compartment on the top of the switchgear.

Thanks to the flexibility of SafeRing/SafePlus modules, grid automation solutions can also be delivered with different switchgear configurations with low voltage compartments if required.

Standard packages for Smart Grid applications can provide monitoring, control, measurement and supervision functionalities including feeder automation devices with wired and/or wireless communication interfaces and power supply back-up.

The already compact SafeRing/SafePlus range can also be delivered as an ultra-compact unit with integrated Smart Grid solutions (reduced overall height of 1'100 mm) to be fitted inside substations with height limitations.

### Customer benefits

The integrated smart grid functionalities enable the network operators to:

- Monitor the grid so that they are able to remotely locate the fault.
- Reconfigure the network so that the faulty part of the network is disconnected.
- Reconfigure the network so that the energy loss is minimized and/or achieve savings for future investments.

Additional benefits for utilities and energy consumers are:

- Improved quality of the power supply.
- Fewer and shorter outages and improved voltage quality.
- Ensured safety for personnel.
- Enhanced operational efficiency and network stability.
- Improved tools for the network operators and the field crews.
- Less need to travel to locations with difficult access.

# 29 Smart Grid applications

Ring main unit for Smart Grid applications is equipped with an advanced Feeder Automation device, which in cooperation with additional devices (e.g. Fault Passage Indicators) provides various data to the remote control centers. Key functions of all standard packages from the factory are described in the next pages. There are seven different selections which give the end users possibility to adjust the package to fit their requirements.

All secondary devices within the ring main unit are powered by a 24V DC battery. The battery is charged by its charger, which needs external power supply:

- 90...264V AC 50/60 Hz or 85...200V DC in case of Feeder Automation device REC603 (internal battery charger) is used.
- 94...132V AC or 184...264V AC 50/60 Hz in case of Feeder Automation device RTU560CIG10 or REC615 (external battery charger) is used.

Please contact us in case you need another main power supply option.

## Remote and local communication

### A. Remote communication (communication to the remote control center)

Default delivery (standard package solution) comes with IEC 60870-5-104 remote communication protocol implementation. The communication media is either wired Ethernet and/or wireless (GSM/GPRS) communication.

Please contact us in case you need another remote communication protocol option.

### B. Local communication (communication between different automation devices within the RMU)

The signals from the ring main unit switches, Fault Passage Indicators and low voltage multi-meters are brought to the Feeder Automation device by two different ways:

- Digital signals (e.g. switch positions indication and control) are hardwired
- Analog signals (e.g. measurements from the Fault Passage Indicators and low voltage multi-meters) are obtained over local communication bus which can be serial Modbus RTU or serial IEC 60870-5-101 communication protocol. Modbus RTU is used within Measurement package together with RTU560CIG10 Feeder Automation device (via its CPA port), IEC 60870-5-101 is used for connecting low voltage multi-meters in case REC603 Feeder Automation device (via its RS1/RS2 ports).

## Monitoring, Control, Measurement packages communication overview:

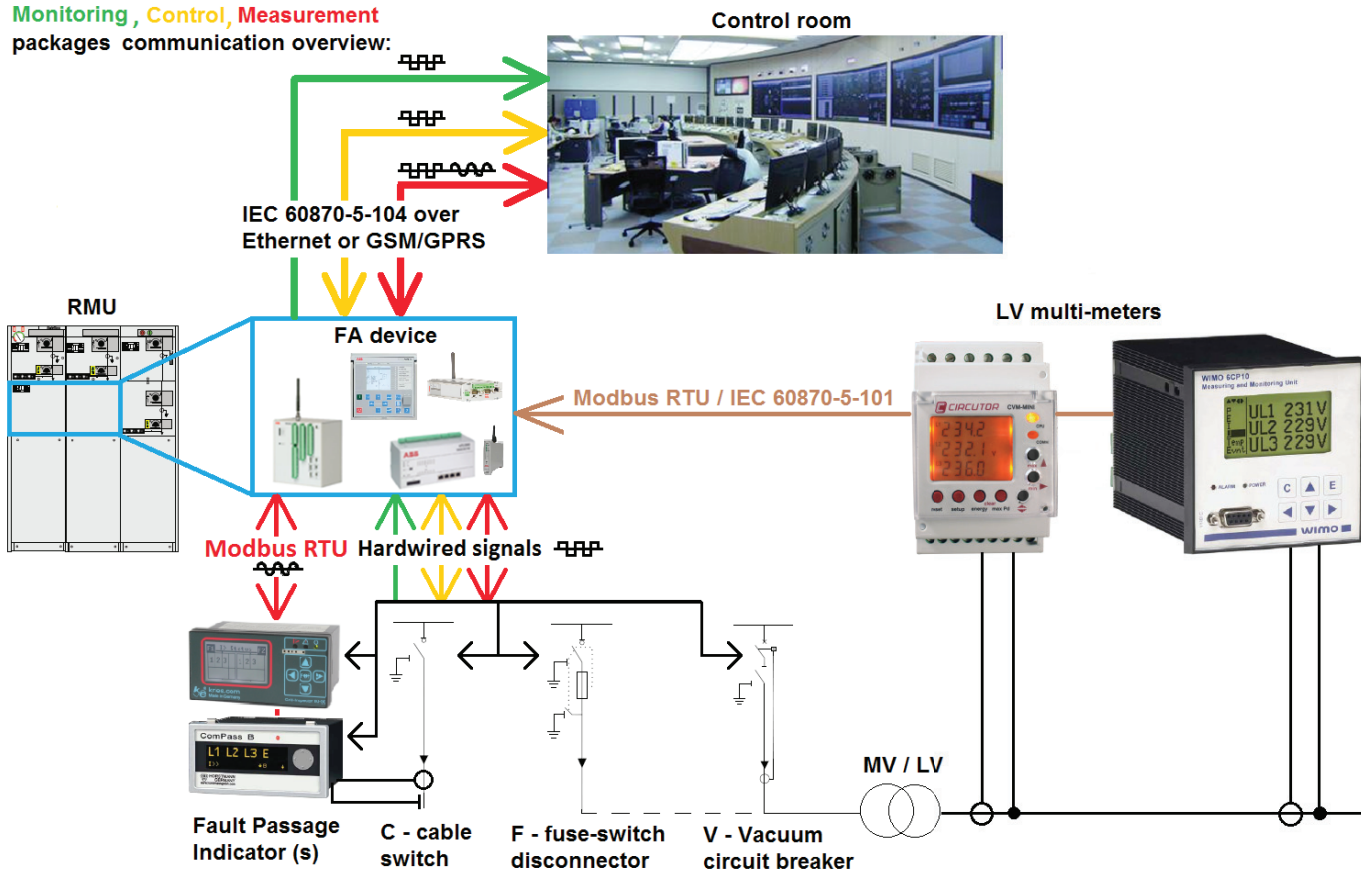

## 29 Smart Grid applications

### Packages

All standard packages include:

- Power supply backup source for automation devices (24V DC batteries and battery charger)
- Wire (Ethernet) and/or wireless (GSM/GPRS) communication interfaces (SIM card is not part of delivery)
- IEC 60870-5-104 host (slave) communication protocol

Three levels of automation packages are defined below.

There are additional options which can be selected for each package.

Main selections and their options are (\*) default values)

#### 1. Automation level

- Remote Monitoring package
- Remote Control package\*)
- Remote Measurement package

#### 2. Feeder automation device

- REC603 \*)
- RTU560CIG10
  - GPRS communication/modem:
  - No \*)
  - RER601
  - 560MDD10
- REC615
  - GPRS communication/modem:
  - None \*)
  - RER601

#### 3. MV network fault types

- OC and EF directional
- OC and EF non directional \*)
- Fault

#### 4. Fault passage indicators

- Kries - IKI-50\_1F (directional)
- Horstmann - ComPass B (directional)
- Kries - IKI-20U2 \*)
- Horstmann - SIGMA F+E (AC/DC)

#### 5. Fault passage indicators remote reset

- No
- Yes \*)

#### 6. Distribution transformer feeders common remote emergency trip

- No
- Yes \*)

#### 7. Supervision of the LV side of the distribution transformer

- None \*)
- Vamp: WIMO 6CP10
- Circutor: CVM-MINI-ITF-RS485-C2

### Options description

#### 1. Automation level

The three automation levels (packages) are described below.

##### Remote Monitoring

This package provides remote monitoring of:

- The position of load break switches in C modules (-> grid topology supervision)
- Fault passage indicator fault signalization (-> fast fault localization, reduced outage time, efficient use of manpower)
- Faults in the transformer feeders

##### Remote Control

This package includes the features from the Remote Monitoring package and in addition provides:

- Remote control of load break switches in C modules (-> fast fault isolation, fast restoration of healthy part of the MV network, operator safety)

##### Remote Measurement

This package includes the features from the Remote Control package and in addition provides:

- MV network analog data values such as: currents, voltages, frequency, power, energy, load flow direction etc. (-> improved notification of overloaded equipment, better maintenance planning, improved power quality).

Note: There are spare inputs (1 – 5 pieces) which can be used for additional customer specified „digital/binary” signals such as: SF<sub>6</sub> gas pressure signal, low voltage fuses tripped signal, transformer overheating signal etc. The number of spare inputs depends on configuration of ring main unit (CCF, CCCF etc.) and on the type of fault detection for the MV network.

#### 2. Feeder automation device

Compact Feeder Automation devices secure remote monitoring and control of the secondary substations in the distribution network. It enables the network control centers to monitor and control the field devices over the different communication infrastructures.

## 29 Smart Grid applications

### REC603

The Wireless Controller REC603 is a compact, solution based device for the remote control and monitoring of secondary substations such as network disconnectors, load break switches and ring main units in distribution networks.

REC603 enables the network control system to monitor and control the field devices over the public communication infrastructure (GPRS). The Wireless Controller REC603 utilizes the built-in GPRS for reliable and secure end-to-end communication providing remote monitoring and control of up to three objects.

### RTU560CIG10

The RTU560 DIN rail provides advanced functionality and makes it the perfect fit for existing and future Grid Automation solutions. The compact housing with the possibility to integrate hardwired information fulfills complex requirements and space restrictions at the same time.

### 3. MV network fault types

Different signals from Fault Passage Indicators can be transmitted to the control centers. These are selected based on type of the MV network (isolated neutral, compensated neutral, high resistance earthing, low resistance earthing or solidly earthing).

Available options are:

OC and EF directional

With this selection, two different types of events can be transferred to the remote control centers:

- Fault in forward direction (does not differentiate over-current and earth-fault)
- Fault in backward direction (does not differentiate over-current and earth-fault)

OC and EF non directional

With this selection, two different types of events can be transferred to the remote control centers:

- Over-current fault (does not differentiate fault direction)
- Earth-fault (does not differentiate fault direction)

Fault

With this selection, one type of event can be transferred to the remote control centers:

- Fault (does not differentiate overcurrent and earth-fault nor fault direction)

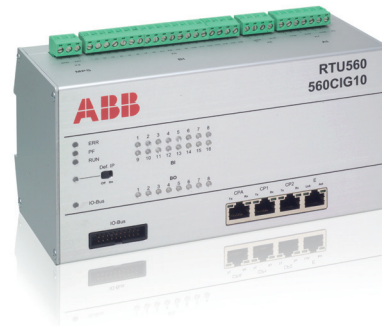

## 29 Smart Grid applications

### 4. Fault Passage Indicators

Fault Passage Indicators are devices which detect faults in the MV network. Some of them are also able to provide MV analog value measurements to the Feeder Automation device which transfers these signals to the control centers.

### 5. Fault passage indicators remote reset

Selection No

The Fault Passage Indicators signalization will be reset according to its setting (e.g. manually, automatically after fixed set time).

Selection Yes

This option gives possibility to reset Fault Passage Indicators remotely from the control centers.

Note: There is one common reset command for all Fault Passage Indicators when using REC603 Feeder Automation device – all Fault Passage Indicators within the ring main unit will be reset at the same time.



### 6. Distribution transformer feeders common remote emergency trip

Selection No

No possibility to remotely trip distribution transformer modules.

Selection Yes

This option gives the possibility to remotely trip distribution transformer modules (usually F and/or V modules) from the control centers.

Note: There is one common trip command for all distribution transformer modules – all modules will be tripped at the same time.

### 7. Supervision of the LV side of the distribution transformer

This option gives the possibility to remotely supervise the secondary (Low Voltage) side of the distribution transformer. Different multi-function monitoring devices with extensive measuring and calculation functions will be available in this selection.

The unit measures currents, voltages and frequencies, and calculates power and energy values. The interconnection cable between Feeder Automation device and low voltage multi-meters is not part of delivery.

None

No possibility to remotely supervise LV network analog data.

## 29 Smart Grid applications



Vamp: WIMO 6CP10

WIMO 6CP10 secondary substation measuring and monitoring unit is a compact multi-function monitoring device with extensive measuring and calculation functions. WIMO 6CP10 is ideal for secondary substation measuring and monitoring management. The unit measures currents, voltages and frequencies, and calculates power and energy values.



Circuitor: CVM-MINI-ITF-RS485-C2

The CVM-MINI panel analyzer is a programmable measuring instrument; it offers a series of options, which may be selected from configuration menus on the instrument itself.

The CVM-MINI measures, calculates and displays the main electrical parameters for three-phase, balanced or unbalanced industrial systems.

Measurements are taken as true effective values using the three alternating and neutral voltage inputs and three current inputs to measure  $I_n / 1A$  or  $I_n / 5A$  secondary from external measurement transformers. The CVM-MINI allows the display of all electrical parameters, using the backlit LCD display, showing three instant electrical parameters, maximum or minimum on each page jump.

Note: The availability depends on the selected Feeder Automation device and ring main unit module configuration. These devices are by default mounted in a top entry box or low voltage compartment.



## 30 Marine applications

SafePlus switchgear is type-certified by DNV and suitable for Marine applications.

The switchgear conforms to environmental, vibration and ingress protection requirements of the DNV Rules.

Available functional units for marine applications are:

- Switch disconnecter module (C)
- Fuse-switch disconnecter module (F)
- Circuit-breaker module (V)

The switchgear is delivered for ratings up to 24 kV and can be manufactured with any combination of the above modules, from 2 up to 5 modules.

SafePlus switchgear for Marine applications provides ingress protection IP 22C as a standard feature.

Available DNV certified ABB protection relays:

- REx615
- REx630

Optional arc suppressor to avoid any damages occurring in case of an internal arc inside the gas tank is available.



### Dimensions

Height	1880 mm
Width	372, 696, 1021, 1346 and 1671 mm (1, 2, 3, 4, 5 functional units)
Depth	765 mm for RMU, 1075 mm including roof

Other data/parameters are identical to data for standard SafePlus

## 30.1 Marine applications IAC AFL

### IAC AFL for marine version of SafePlus

With this set-up, hot gases and pressure are evacuated behind the switchgear through the pressure flap.

Basic parameters of set-up:

- IAC AFL up to 20 kA / 1 s
- Minimum height of ceiling: 2085 mm
- Minimum distance from backwall: 300 mm
- Recommended distance to sidewall is minimum 300 mm

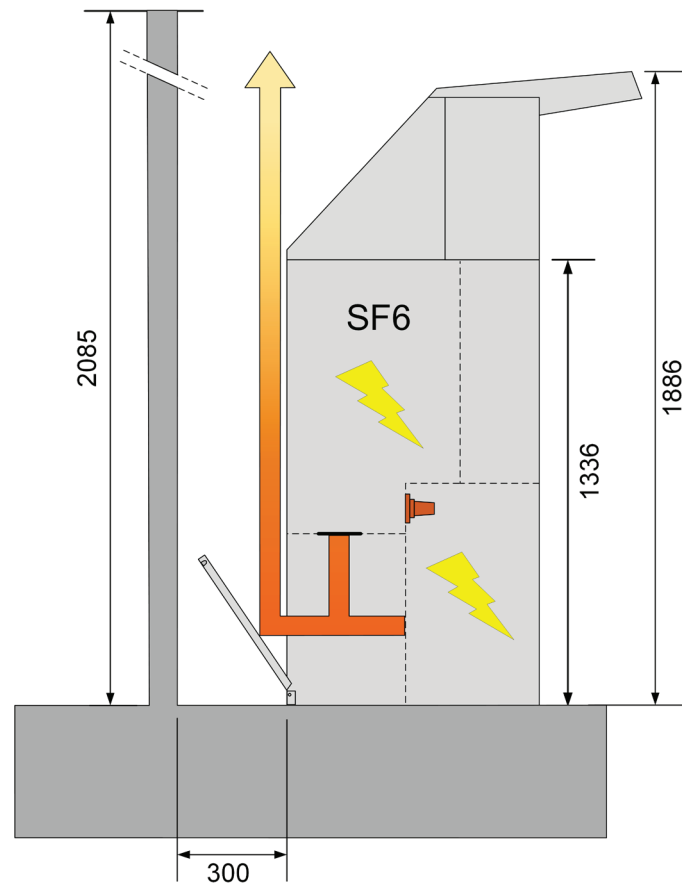

## 31 Low version switchgear

Available functional units for low version applications are the same as for standard SafeRing/SafePlus, except for the metering and CB-modules.

The switchgear is delivered for ratings up to 24kV and can be manufactured in any combination of the SafeRing/SafePlus modules, from 1 up to 5 modules.

Optional arc suppressor to avoid any damages occurred in case of an internal arc inside the gas tank is available.

- CT's must be placed beneath the switchgear
- Height: 1100 mm
- Same width as standard units
- Only arc proof cable compartment door is available

### IAC AFL for low version of SafePlus

For the low-version switchgear, AFL is the highest IAC-classification.

Available solutions are blow-out down to cable trench.

Basic parameters of set-up:

- IAC AFL up to 20 kA / 1 s
- Minimum height of ceiling for blow-out down to cable trench: 2000 mm
- Minimum height of ceiling for blow-out behind switchgear: 2400 mm
- Minimum distance from backwall: 100 mm

Parameters and technical data are the same as for standard SafeRing/SafePlus.



## 32 Dimensions

Height (mm)		Standard switchgear					Lower version switchgear		
		Non IAC/IAC AFL without base frame	Non IAC/IAC AFL with 290 mm base frame	Non IAC/IAC AFL with 450 mm base frame	IAC AFLR with 290 mm base frame	IAC AFLR with 450 mm base frame	Non IAC/IAC AFL without base frame	Non IAC/IAC AFL with 290 mm base frame	Non IAC/IAC AFL with 450 mm base frame
without low voltage compartment or top entry box	Standard	1336	1626	1786	2002	2002	1100	1390	1550
	Top connection without dead ends	1466	1756	1916	2002	2002	1230	1520	1680
	Top connection with dead ends	1561	1851	2011	2002	2002	1325	1615	1775
	External busbars	1591	1881	2041	2002	2041	1355	1645	1805
	Busbar cover	1651	1941	2101	2002	2101	1415	1705	1865
with top entry box (124 mm)	Standard	1460	1750	1910	2002	2002	1224	1514	1674
	Top connection without dead ends	1466	1756	1916	2002	2002	1230	1520	1680
	Top connection with dead ends	1561	1851	2011	2002	2011	1325	1615	1775
	External busbars	1591	1881	2041	2002	2041	1355	1645	1805
	Busbar cover	1651	1941	2101	2002	2101	1415	1705	1865
with low voltage compartment (470 mm) *)	Standard	1806	2096	2256	2096	2256	1570	1860	2020
	Top connection without dead ends	1806	2096	2256	2096	2256	1570	1860	2020
	Top connection with dead ends	1806	2096	2256	2096	2256	1570	1860	2020
	External busbars	1806	2096	2256	2096	2256	1570	1860	2020
	Busbar cover	1806	2096	2256	2096	2256	1570	1860	2020
with low voltage compartment (700 mm) *)	Standard	2036	2326	2486	2326	2489	1800	2090	2250
	Top connection without dead ends	2036	2326	2486	2326	2486	1800	2090	2250
	Top connection with dead ends	2036	2326	2486	2326	2486	1800	2090	2250
	External busbars	2036	2326	2486	2326	2486	1800	2090	2250
	Busbar cover	2036	2326	2486	2326	2486	1800	2090	2250

\*) For V-module 12kV/25kA and 24kV/20kA height of low voltage compartment is 570 / 800 mm, so 100 mm has to be added to the total switchgear heights in the table

# 32 Dimensions

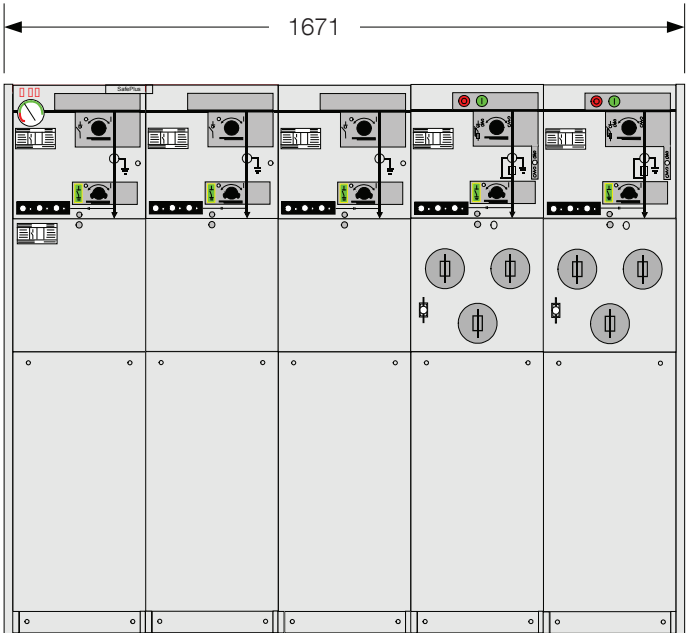
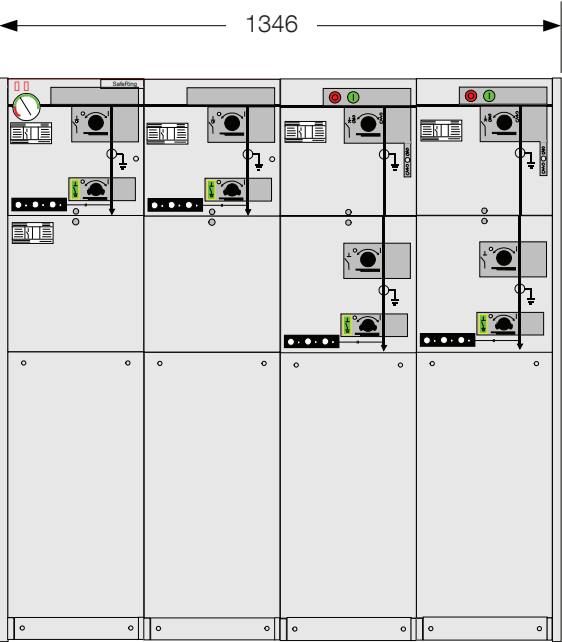
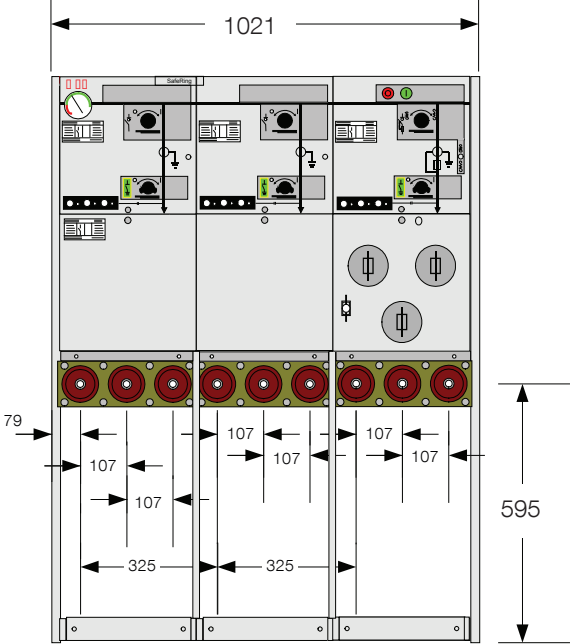
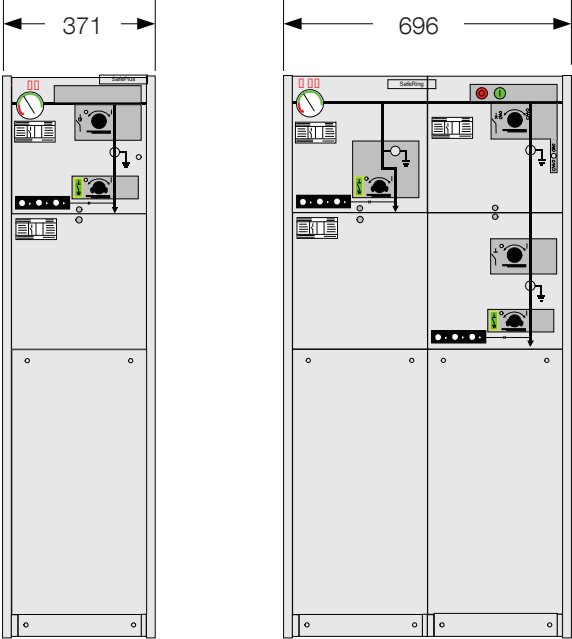

## 32 Dimensions

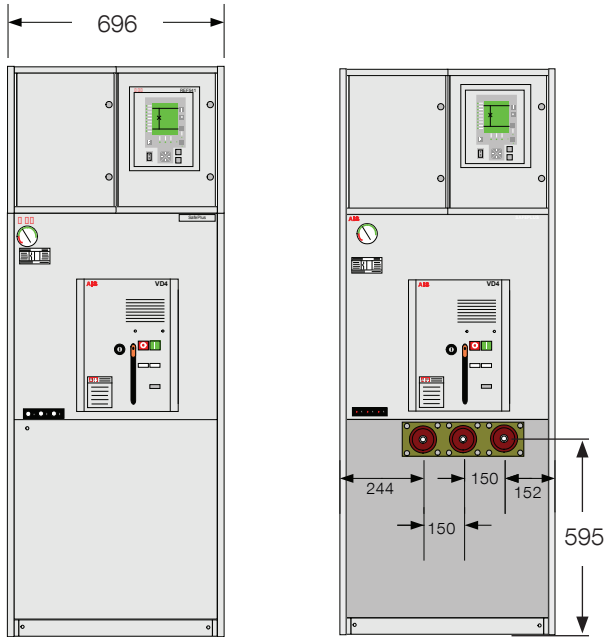

CB modul

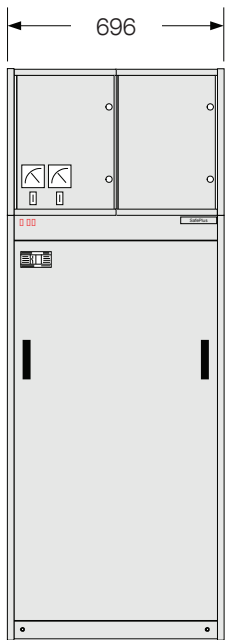

Metering module M, front view

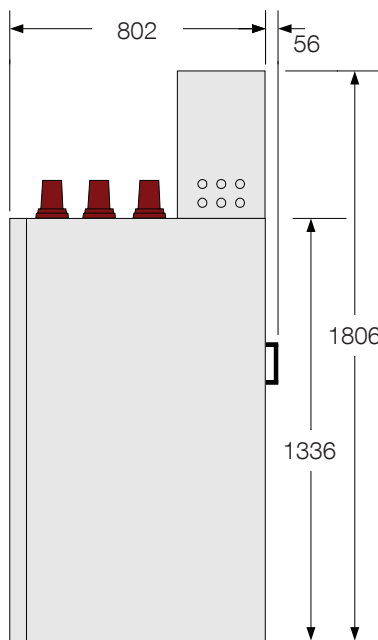

Metering module M, side view right

# 32 Dimensions

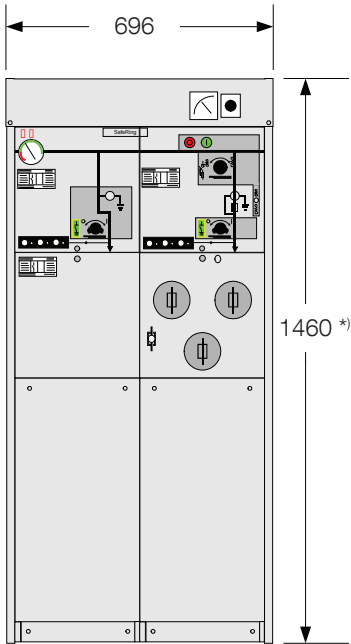

Top entry box with ammeter and position switch  
 \*) standard height for switchgear with V20/V25

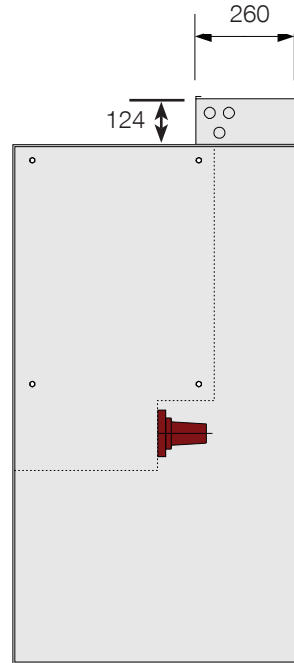

Top entry box - side view

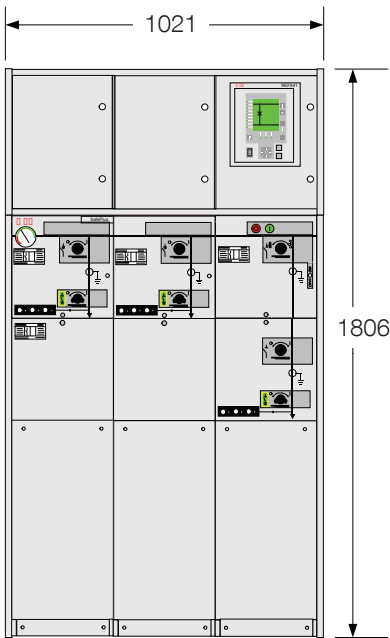

Low voltage compartment with REF541

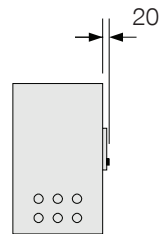

Low voltage compartment with REF542plus

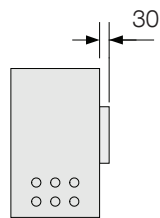

Low voltage compartment with REF610, 611, 615

## 32 Dimensions

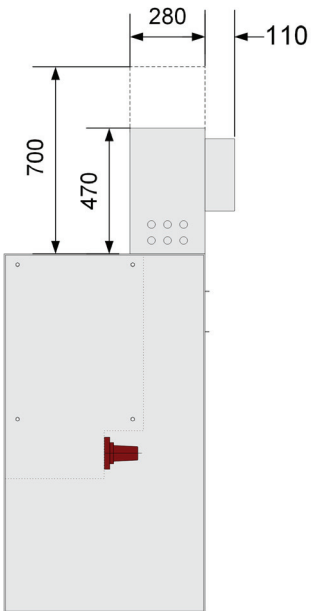

Low voltage compartment with relay type REF541

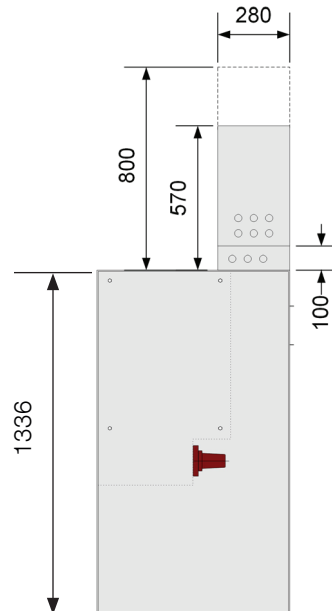

Low voltage compartment for V20/V25

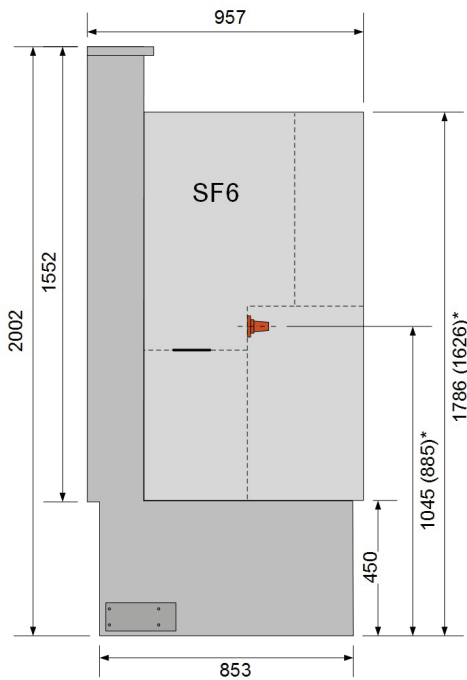

AFLR base frame

\* Dimensions for 290 mm base frame

Note: Height of exhaust channel is always 2002 mm, according to requirements in IEC standards. When base frame is 290 mm, the exhaust channel is extended to reach 2002 mm height

### Dimensions operating handle

Part no.	1VDP000443R1	1VDP000437R1	2RAA027294A1
Description	Standard handle	Long shaft	Extra long shaft
A	136 mm	293 mm	443 mm
B	133 mm	290 mm	440 mm
C	468 mm	393 mm	468 mm

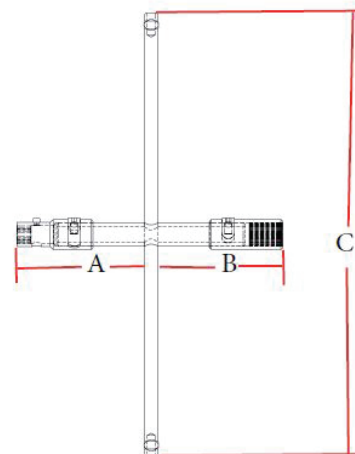



## 32 Dimensions

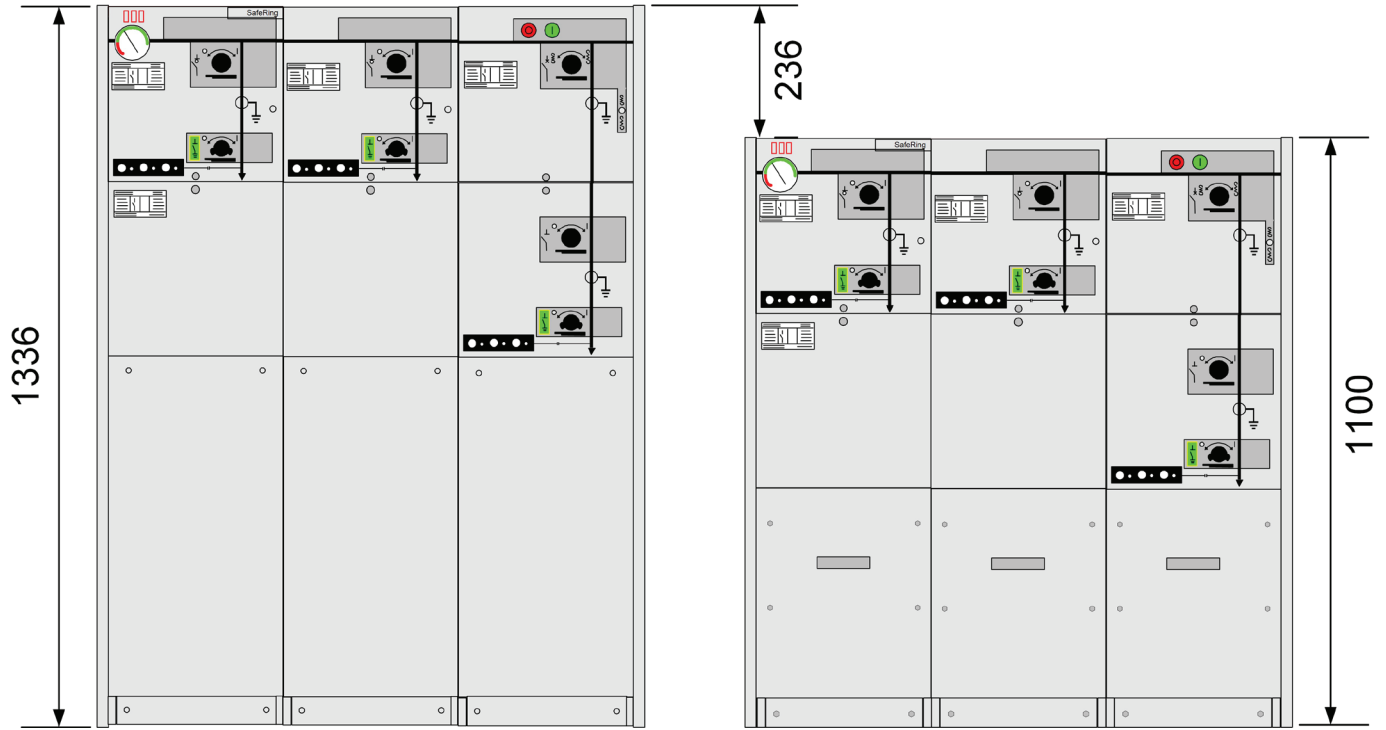

Standard version compared to lower version. Lower version is an optional solution.

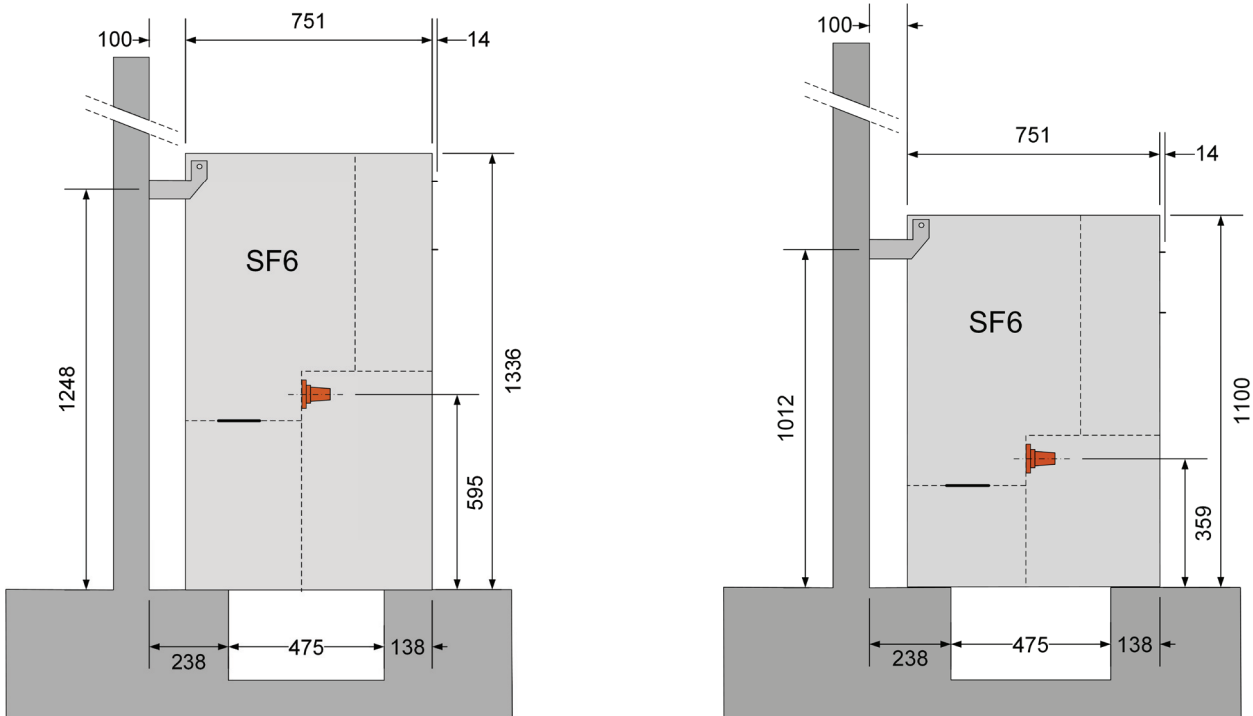

# 32 Dimensions

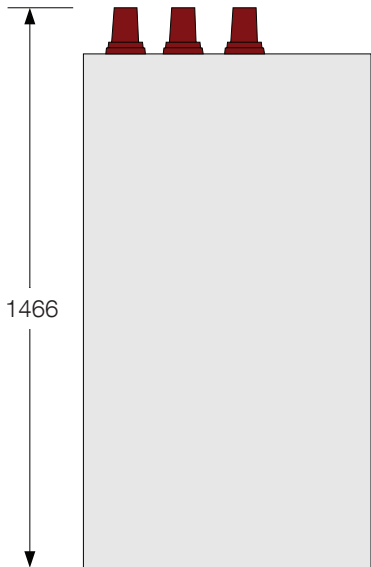

Bushings for connection of external busbars

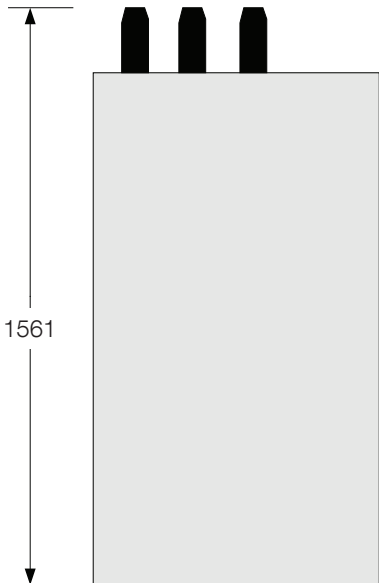

Prepared for future extension with dead end receptacles

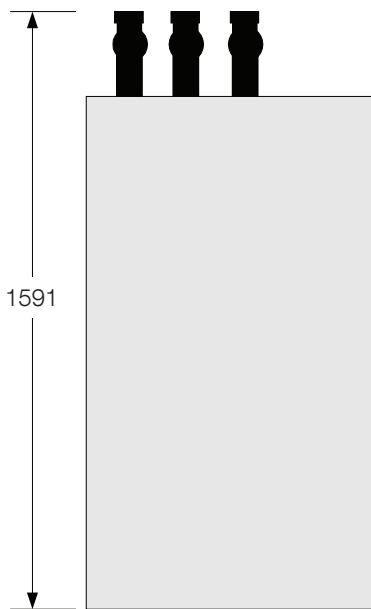

External busbars

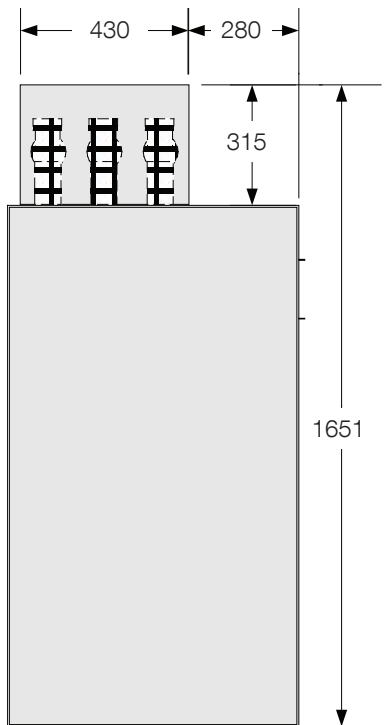

Busbar cover

# 32 Dimensions

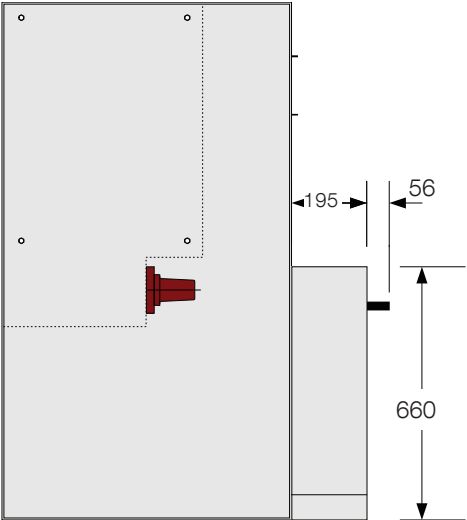

Cable compartment cover for parallel cables

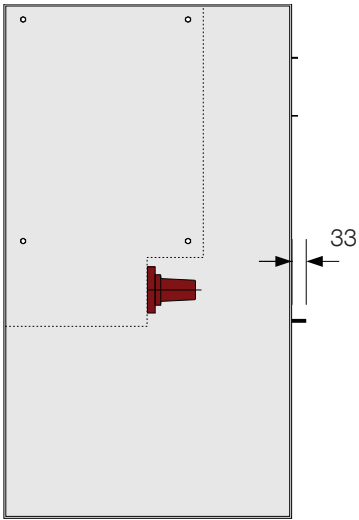

Arc proof cable cover

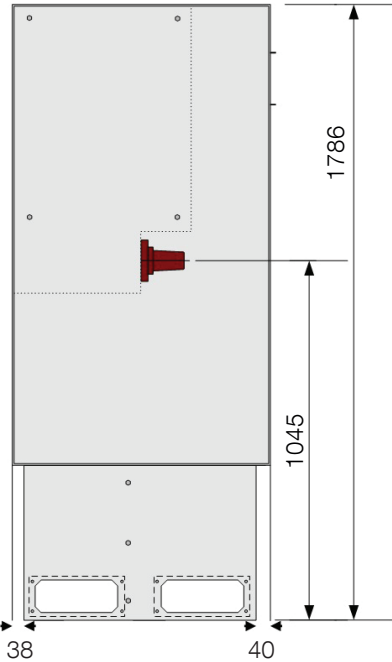

Base frame, height 450 mm

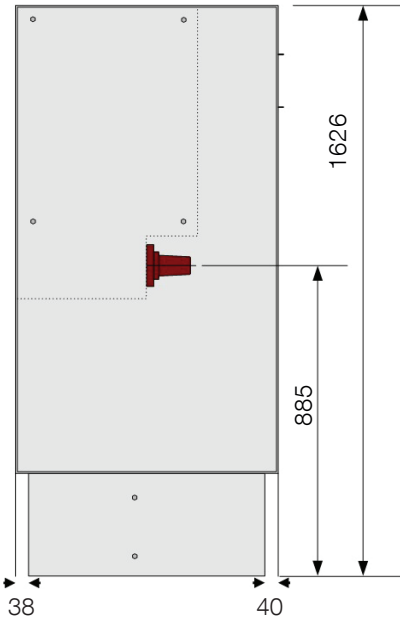

Base frame, height 290 mm

## 33 Technical data

### Codes and standards

SafeRing and SafePlus are manufactured and tested in accordance with the latest version of the below IEC regulations

IEC 62271-1	Common specifications for high-voltage switchgear and controlgear standards
IEC 62271-100	High-voltage switchgear and controlgear - Part 100: High-voltage alternating-current circuit-breakers
IEC 62271-102	High-voltage switchgear and controlgear - Part 102: Alternating current disconnectors and earthing switches
IEC 62271-105	High-voltage switchgear and controlgear - Part 105: Alternating current switch-fuse combinations
IEC 62271-200	High-voltage switchgear and controlgear - Part 200: A.C. metal-enclosed switchgear and controlgear for rated voltages above 1 kV and up to and including 52 kV
IEC 62271-103	High-voltage switches- Part 1: Switches for rated voltages above 1 kV and less than 52 kV
IEC 60529	Degrees of protection provided by enclosures (IP code)

Voltage detection system (VDS)	IEC 61243-5
Voltage presence indication systems (VPIS)	IEC 62271-206, IEC 61958
Bushings	CENELEC EN 50180 / EN 50181, IEC 61243-5, IEC 62271-206, IEC 60137, EDF HN 52-S-61
Electronic protection relays	IEC 60255
Instrument transformers - general requirements	IEC 61869-1
Current instrument transformers	IEC 61869-2
Voltage instrument transformers	IEC 61869-3
Current sensors	IEC 60044-8
Voltage sensors	IEC 60044-7
Combined bushings sensors	IEC 60044-7, IEC 60044-8, CENELEC EN 50181, IEC 62271-206, IEC 61243-5
MV fuses	IEC 60282-1
Cable connection	CENELEC EN 50180, CENELEC EN 50181, IEC 60137, IEC 60502-4

## 33.1 Technical data - SafeRing

### SafeRing - ring main unit, electrical data

1	Rated voltage	U <sub>r</sub>	kV	12	17,5	24
2	Rated power frequency withstand voltage - across disconnecter	U <sub>d</sub>	kV	28 <sup>4)</sup> 32	38 45	50 60
3	Rated lightning impulse withstand voltage - across disconnecter	U <sub>p</sub>	kV	95 110	95 110	125 145
4	Rated frequency <sup>5)</sup>	f <sub>r</sub>	Hz	50/60	50/60	50/60
5	Rated normal current (busbars)	I <sub>r</sub>	A	630	630	630
6	Rated normal current (cable switch)	I <sub>r</sub>	A	630	630	630
7	Rated normal current (switch-fuse-disconnector)	I <sub>r</sub>	A	200 <sup>1)</sup>	200 <sup>1)</sup>	200 <sup>1)</sup>
8	Rated normal current (vacuum circuit-breaker)	I <sub>r</sub>	A	200	200	200
9	Rated short-time withstand current	I <sub>k</sub>	kA	21 <sup>3)</sup>	16 <sup>3)</sup>	16 <sup>3)</sup>
10	Rated duration of short-circuit	t <sub>k</sub>	s	3	3	3
11	Rated peak withstand current	I <sub>p</sub>	kA	52,5	40	40
12	Internal arc classification IAC AFL	I <sub>ac</sub>	kA/s	20/1	20/1	20/1
13	Internal arc classification IAC AFLR	I <sub>ac</sub>	kA/s	20/1	20/1	20/1
14	Loss of service continuity			LSC 2-PM, F-module LSC 2A-PI		
Making and breaking capacities C-module:						
15	Rated mainly active load breaking current	I <sub>load</sub>	A	630	630	630
16	Number of operations for mainly active load breaking	n		100	100	100
17	Rated distribution line closed-loop breaking current	I <sub>loop</sub>	A	650	650	650
18	Rated no-load transformer breaking current	I <sub>cc</sub>	A	20	17	17
19	Rated single capacitor bank breaking current	I <sub>sb</sub>	A	140	140	140
20	Rated earth-fault breaking current	I <sub>ef1</sub>	A	205	160	160
21	Rated cable- and line-charging breaking current under earth-fault conditions	I <sub>ef2</sub>	A	117	91	91
22	Rated short-circuit making current	I <sub>ma</sub>	kA	52,5	40	40
23	Cable charging capacity	I <sub>cc2</sub>	A	65	52	52
24	Line charging capacity	I <sub>lc</sub>	A	1	1	1
25	Electrical and mechanical classes			E3, C2, M1		
Making and breaking capacities F-module:						
26	Rated making capacity <sup>2)</sup>	I <sub>ma</sub>	kA	21	16	16
27	Rated making capacity (downstream earthing switch)	I <sub>ma</sub>	kA	12,5	12,5	12,5
28	Rated short-time current (downstream earthing switch)	I <sub>k</sub>	kA	5	5	5
29	Rated duration of short-circuit	t <sub>k</sub>	s	1	1	1
30	Electrical and mechanical classes			E3, M1		
Making and breaking capacities V-module:						
31	Rated short-circuit breaking current	I <sub>sc</sub>	kA	16	16	16
32	Rated cable-charging breaking current	I <sub>c</sub>	A	31,5	31,5	31,5
33	Rated short-time current (earthing switch)	I <sub>k</sub>	kA	16	16	16
34	Rated short-circuit making current (earthing switch)	I <sub>ma</sub>	kA	40	40	40
35	Electrical and mechanical classes			E2, C2, S1, M1		

<sup>1)</sup> T-off fuse module: depending on the current rating of the fuse

<sup>2)</sup> T-off fuse module: limited by high voltage fuse-links

<sup>3)</sup> Valid with Interface C bushings (bolted type) only

<sup>4)</sup> GOST version is available with 42kV power frequency withstand voltage

<sup>5)</sup> De-rating for current parameters needs to be applied for 60Hz

## 33.2 Technical data - SafePlus

### SafePlus - Compact Switchgear, electrical data

1	Rated voltage	$U_r$	kV	12	17,5	24
2	Rated power frequency withstand voltage - across disconnector	$U_d$	kV	28 <sup>6)</sup> 32	38 45	50 60
3	Rated lightning impulse withstand voltage - across disconnector	$U_p$	kV	95 110	95 110	125 145
4	Rated frequency <sup>8)</sup>	$f_r$	Hz	50/60	50/60	50/60
5	Rated normal current (busbars)	$I_r$	A	630	630	630
6	Rated normal current (external busbars)	$I_r$	A	1250	1250	1250
7	Rated normal current (cable switch)	$I_r$	A	630	630	630
8	Rated normal current (switch-fuse-disconnector) <sup>1)</sup>	$I_r$	A	200	200	200
9	Rated normal current (vacuum circuit-breaker) <sup>3)</sup>	$I_r$	A	630	630	630
10	Rated short-time withstand current <sup>3) 7)</sup>	$I_k$	kA	25	21	21
11	Rated duration of short-circuit	$t_k$	s	3	3	3
12	Rated peak withstand current	$I_p$	kA	62,5	52,5	52,5
13	Internal arc classification IAC AFL	$I_{ac}$	kA/s	20/1	20/1	20/1
14	Internal arc classification IAC AFLR	$I_{ac}$	kA/s	25/1	25/1	25/1
15	Loss of service continuity			LSC 2-PM, F-Module LSC 2A-PI, M-module LSC 2B-PM <sup>10)</sup>		
Making and breaking capacities C-module:						
16	Rated mainly active load breaking current	$I_{load}$	A	630	630	630
17	Number of operations for mainly active load breaking	$n$		100	100	100
18	Rated distribution line closed-loop breaking current	$I_{loop}$	A	650	650	650
19	Rated no-load transformer breaking current	$I_{cc}$	A	20	17	17
20	Rated single capacitor bank breaking current	$I_{sc}$	A	140	140	140
21	Rated earth-fault breaking current	$I_{ef1}$	A	205	160	160
22	Rated cable- and line-charging breaking current under earth-fault conditions	$I_{ef2}$	A	117	91	91
23	Rated short-circuit making current	$I_{ma}$	kA	62,5	52,5	52,5
24	Cable charging capacity	$I_{cc2}$	A	65	52	52
25	Line charging capacity	$I_{lc}$	A	1	1	1
26	Electrical and mechanical classes			E3, C2, M1		
Making and breaking capacities F-module:						
27	Rated making capacity <sup>2)</sup>	$I_{ma}$	kA	25	20	20
28	Rated making capacity (downstream earthing switch)	$I_{ma}$	kA	12,5	12,5	12,5
29	Rated short-time current (downstream earthing switch)	$I_k$	kA	5	5	5
30	Rated duration of short-circuit	$t_k$	s	1	1	1
31	Electrical and mechanical classes			E3, M1		
Making and breaking capacities V-module:						
32	Rated mainly active load breaking current <sup>3)</sup>	$I_l$	A	630	630	630
33	Rated short-circuit breaking current	$I_{sc}$	kA	21	16	16
34	Rated cable-charging breaking current	$I_c$	A	31,5	31,5	31,5
35	Rated short-time current (earthing switch)	$I_k$	kA	21	16	16
36	Rated short-circuit making current (earthing switch)	$I_{ma}$	kA	52,5	40	40
37	Electrical and mechanical classes			E2, C2, S1, M1		
Making and breaking capacities V20-, V25-module:						
38	Rated mainly active load breaking current <sup>3)</sup>	$I_l$	A	630	630	630
39	Rated short-circuit breaking current	$I_{sc}$	kA	25	25	20
40	Making capacity load break switch	$I_{ma}$	A	62,5	62,5	50
41	Rated short-time current (earthing switch)	$I_k$	kA	25	21	21
42	Rated short-circuit making current (earthing switch)	$I_{ma}$	kA	62,5	52,5	52,5
43	Electrical and mechanical classes			E2, C2, S1, M1		
Making and breaking capacities CB-module:						
44	Rated mainly active load breaking current <sup>3)</sup>	$I_l$	A	630/1250	630/1250	630/1250
45	Rated short-circuit breaking current	$I_{sc}$	kA	25	20	20
46	Making capacity	$I_{ma}$	A	65	52	52
47	Rated short-time current	$I_k$	kA	25	20	20
48	Electrical and mechanical classes			E2, C2, M2		

## 33.3 Technical data - general

Normal service conditions for indoor switchgear according to IEC 62271-200						
49	Ambient temperature <sup>4)</sup>					
50	Maximum value	°C	+40	+40	+40	+40
51	Maximum value of 24 hours mean	°C	+35	+35	+35	+35
52	Minimum value <sup>9)</sup>	°C	-25	-25	-25	-25
53	Altitude for installation above sea level <sup>5)</sup>	m	1500	1500	1500	1500
54	Relative humidity max. 24 hour mean		95%	95%	95%	95%

<sup>1)</sup> T-off fuse module: depending on the current rating of the fuse

<sup>2)</sup> T-off fuse module: limited by high voltage fuse-links

<sup>3)</sup> Valid with Interface C bushings (400 series bolted type) only

<sup>4)</sup> De-rating allows for higher maximum temperature

<sup>5)</sup> For installation above 1500 m, reduced gas pressure is required

<sup>6)</sup> GOST version is available with 42kV power frequency withstand voltage

<sup>7)</sup> Duration and time can vary based on type of modules used in CSG

<sup>8)</sup> De-rating for current parameters needs to be applied for 60Hz

<sup>9)</sup> Lower temperature available upon request

<sup>10)</sup> LSC 1 in case module is connected at least on one side directly to the busbars

### General data, enclosure and dimensions

1	Type of ring main unit (RMU) and compact switchgear (CSG)	Metal-enclosed switchgear and controlgear according to IEC 62271-200			
2	Number of phases	3			
3	Type-tested RMU and CSG	Yes			
4	Pressure test on equipment tank or containers	2.64 bar abs			
5	Facility provided with pressure relief	Yes			
6	Insulating gas	SF <sub>6</sub>			
7	Nominal operating gas pressure	1,4 bar abs 20°C			
8	Rated filling level for insulation P <sub>R</sub>	1,4 bar			
9	Minimum functional level of insulation P <sub>me</sub>	1,3 bar			
10	Gas leakage rate / annum	< 0,1%			
11	Expected operating lifetime	30 years			
12	Facilities provided for gas monitoring <sup>1)</sup>	Yes, temperature compensated manometer can be delivered			
13	Material used in tank construction	Stainless steel sheet, 2,5 mm			
14	Busbars	240 mm <sup>2</sup> Cu			
15	Earth bar (external)	100 mm <sup>2</sup> Cu			
16	Earth bar bolt dimension	M10			
	Overall dimensions of the fully assembled RMU	Height mm	Depth mm	Width mm	
17	2-way unit	1336	765	696	
18	3-way unit	1336	765	1021	
19	4-way unit	1336	765	1346	
	CSG (2, 3 and 4 way units as RMU) with additional height for optional low voltage compartment (470 mm)				
20	1-way unit	1336	765	371	
21	5-way unit	1336	765	1671	
22	Distance between units when external extension is used		8 mm		
23	Distance between units when side extension is used		14 mm		

<sup>1)</sup> Manometer with 1NO or 1NO/1NC upon request

## 33.3 Technical data - general

### Weight table

#### Maximum weights for standard SafeRing

2-way DeV	300 kg	2-way DeF	300 kg
3-way CCV	450 kg	3-way CCF	450 kg
4-way CCCV	600 kg	4-way CCCF	600 kg
4-way CCV	600 kg	4-way CCFF	600 kg
3-way CCC	450 kg		
4-way CCCC	600 kg		

#### SafePlus

Standard 1-way	150 kg
2-, 3- and 4-way	as for SafeRing
5-way	750 kg
M - metering module incl. transformers	250 kg
Mt - metering tariff module incl. transformers	350 kg

### Operations, degree of protection and colours

1	Means of switch operation	separate handle
2	Means of fuse switch/circuit-breaker operation	separate handle and push buttons
3	Rated operating sequence of circuit-breaker (V-module)	O – 3 min – CO – 3 min – CO
4	Rated operating sequence of circuit-breaker (CB-module)	O – 0,3 s – CO – 15s – CO
5	Total opening time of circuit-breaker	approx. 75 ms
6	Closing time of circuit-breaker	approx. 40 – 60 ms
7	Mechanical operations of switch	1000 CO - class M1
8	Mechanical operations of earthing switch	1000 CO - class M1
9	Mechanical operations of circuit-breaker (V-module)	2000 CO - class M1
10	Mechanical operations of circuit-breaker (CB-module)	30000 CO - class M3
11	Principle switch-disconnector and earthing switch	3 position combined switch-disconnector and earthing switch
<b>Load break switch:</b>		
12	Rated operations on short circuit current (class E3)	5 - class E3
13	Rated operations mainly active load (class E3)	100 - class E3
<b>Degree of protection:</b>		
14	High voltage live parts, SF <sub>6</sub> tank	IP 67
15	Front cover mechanism	IP 2XC
16	Cable covers	IP 3X
17	Protection class of fuse compartment	IP 67
18	Low voltage compartment	IP 2XC (IP22 on request)
<b>Colours:</b>		
18	Front covers	RAL 7035
19	Side and cable covers	RAL 7035

### Fuses, cable compartment

1	Standard fuse-link length	442 mm. Shorter fuse-links can be used with fuse adapter
2	Standard dimensions	According to DIN 43625
3	Maximum size 12kV	125 A
4	Maximum size 24kV	63 A
<b>Cable box for heat shrinkable termination:</b>		
5	Phase to phase clearance	107 mm
6	Phase to earth clearance	54,5 mm
7	Phase to earth over insulator surface (creepage)	120 mm
8	Type of cable termination adapters	Elbow or T-connector



## 33.4 Technical data - number of operations

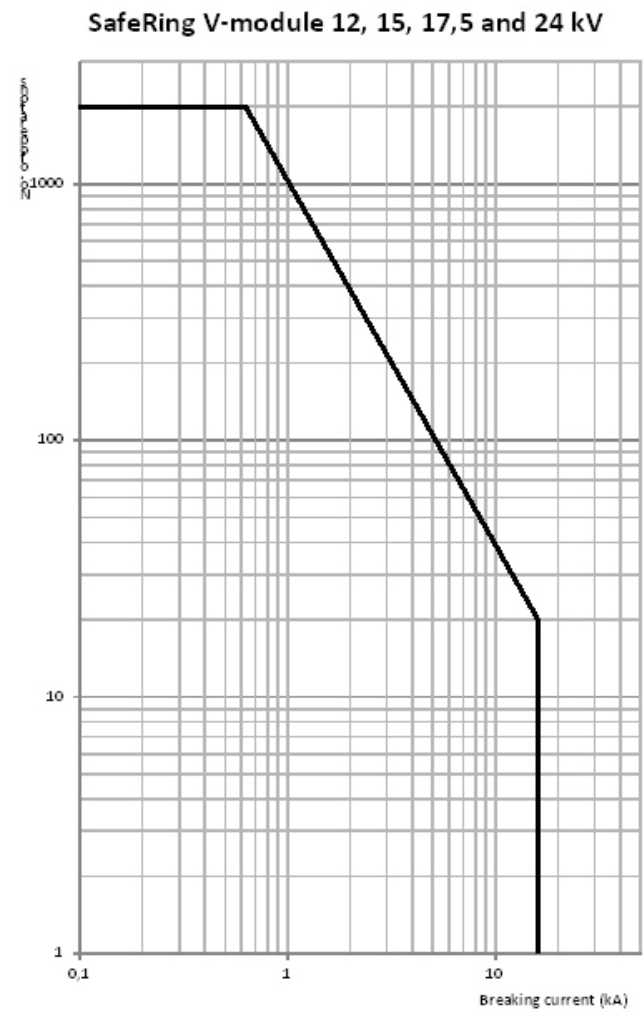
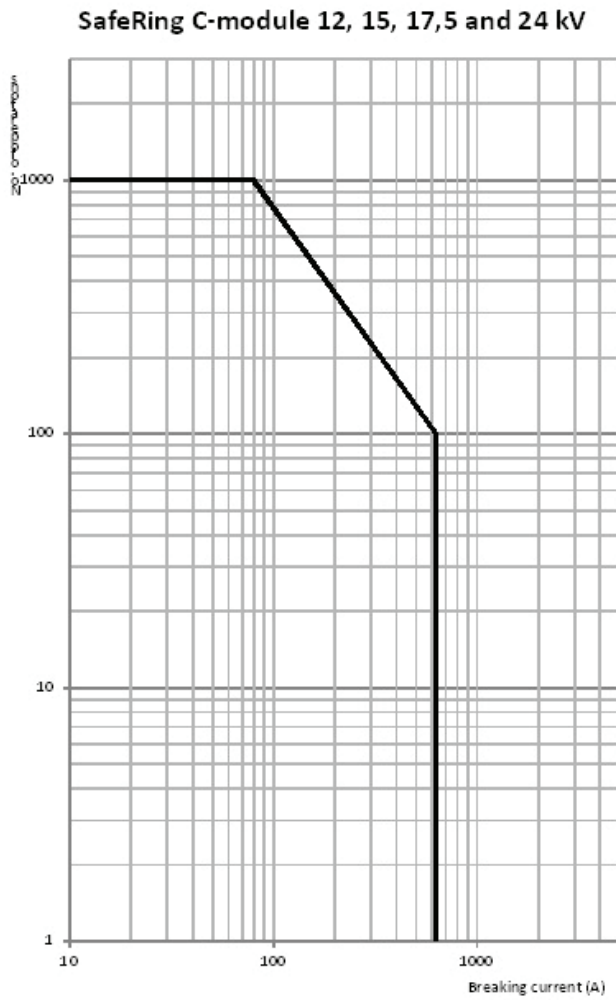

## 33.4 Technical data - number of operations

SafePlus V-module 12, 15, 17,5 and 24 kV

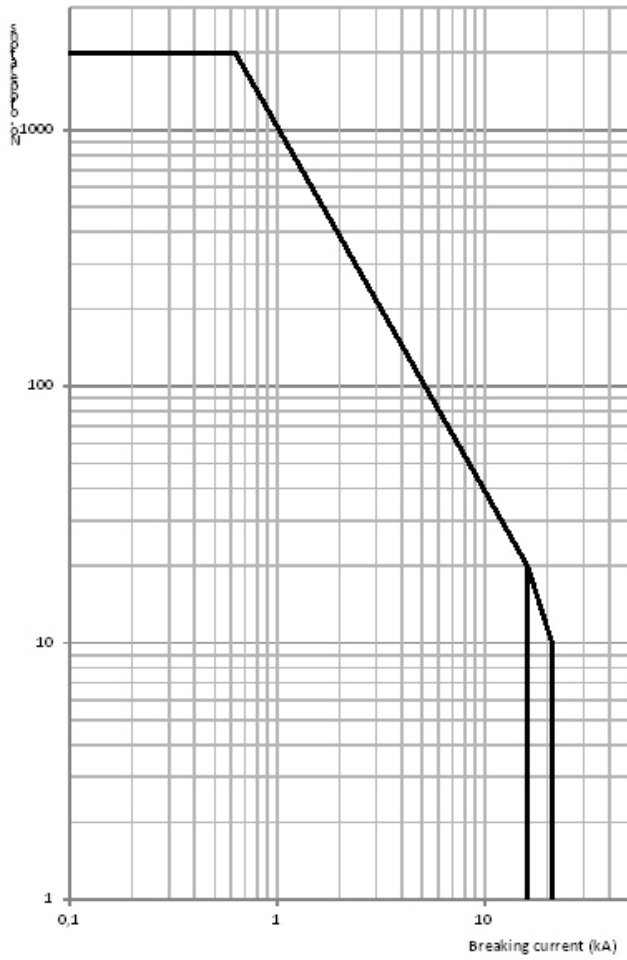

SafePlus V20 12, 15, 17,5 and 24 kV VG5

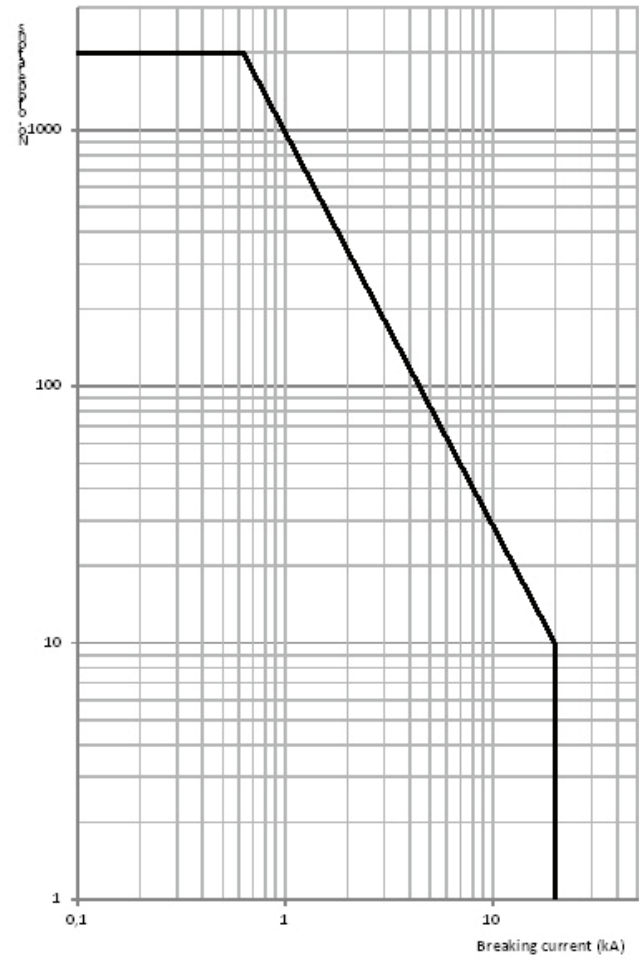

# 33.4 Technical data - number of operations

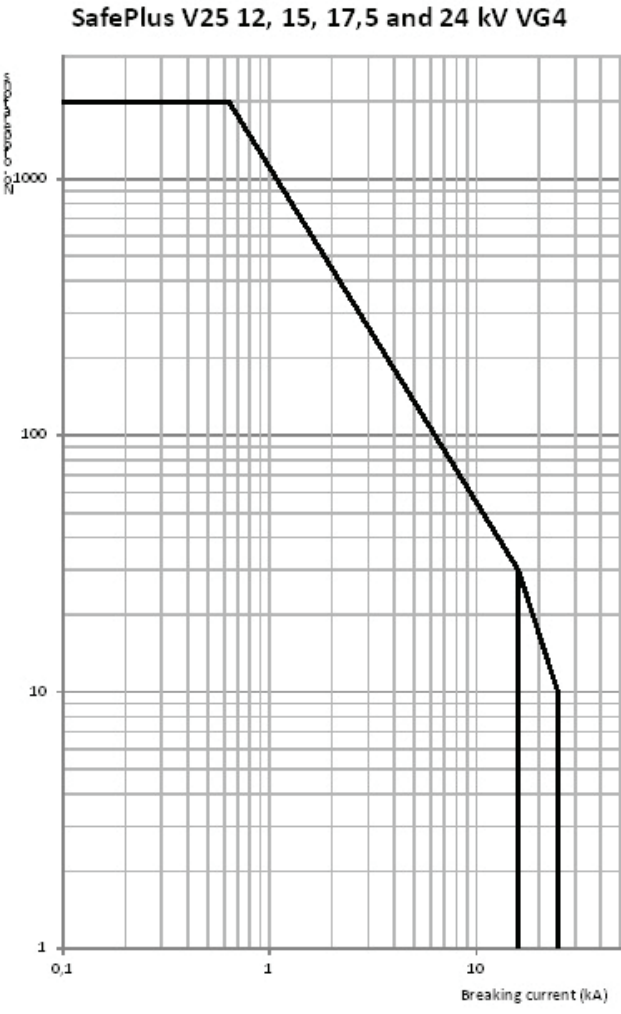

## 33.4 Technical data - number of operations

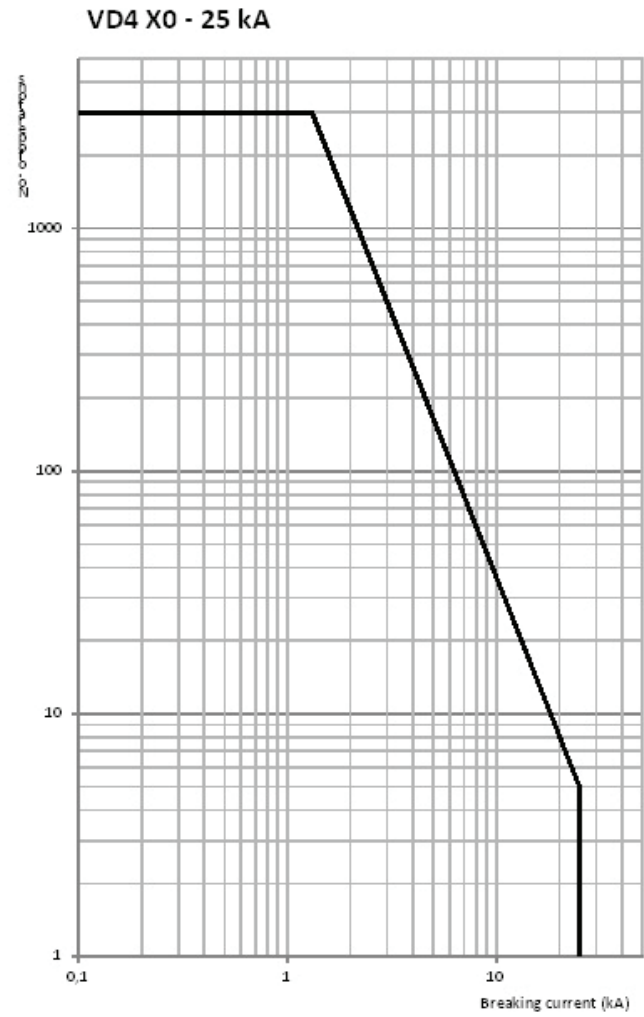
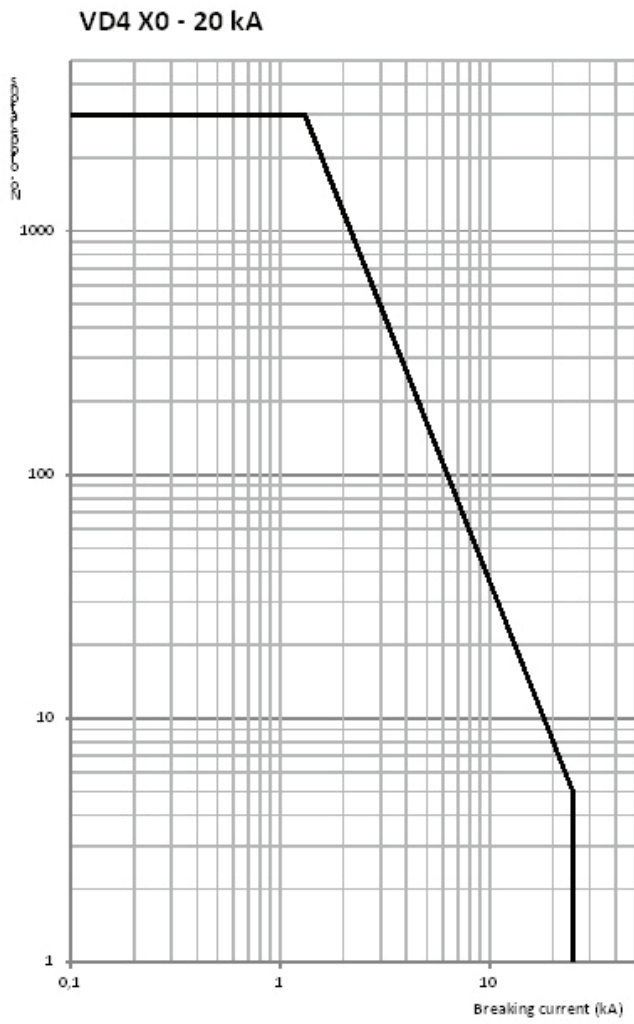

## 35 Environmental Certification

### Environmental Certification

#### Life expectancy of product

The product is developed in compliance with the requirements denoted by IEC 62271-200. The design incorporates a life-span under indoor service conditions exceeding 30 years (IEC 62271-200 annex GG).

The switchgear is gas-tight with an expected diffusion rate of

less than 0.1 % per annum. Referring to the reference-pressure of 1.4 bar, the switchgear will maintain gas-tightness and a gas-pressure better than 1.3 bar\* throughout its designed lifespan. \*) at 20°C.

#### Recycling capability

Raw Material	Weight (kg)	% of total weight	Recycle	Environmental effects & recycle/reuse processes
Iron	132,80	42,53	Yes	Separate, utilise in favour of new source (ore)
Stainless steel	83,20	24,93	Yes	Separate, utilise in favour of new source (ore)
Copper	43,98	14,09	Yes	Separate, utilise in favour of new source (ore)
Brass	2,30	0,74	Yes	Separate, utilise in favour of new source (ore)
Aluminium	8,55	2,74	Yes	Separate, utilise in favour of new source (ore)
Zinc	3,90	1,25	Yes	Separate, utilise in favour of new source (ore)
Silver	0,075	0,024	Yes	Electrolysis, utilise in favour of new source
Thermoplastic	5,07	1,63	Yes	Make granulate, re-use or apply as high-grade energy additive in cement mill
Epoxy incl. 60% quartz	26,75	8,35	Yes	Grind to powder and use as high-grade energy additive in cement mill
Rubber	1,35	0,42	Yes	High-grade energy additive in refuse incineration
Dielectric coil	0,21	0,066	Yes	Reclaim or use as high-grade energy additive in refuse incineration
SF <sub>6</sub> gas	3,24	1,04	Yes	ABB AS in Skien is equipped to reclaim used SF <sub>6</sub> gas
<b>Total recyclables</b>	<b>311,44</b>	<b>97,25</b>		
Not specified <sup>1)</sup>	9,00			<sup>1)</sup> Stickers, film-foils, powder coating, screws, nuts, tiny components, grease
<b>Total weight <sup>2)</sup></b>	<b>320,00</b>	<b>100 %</b>		
Packing foil	0,20		Yes	High-grade energy additive in refuse incineration
Wooden pallet	21,50		Yes	Re-use of use as energy additive in refuse incineration

<sup>2)</sup>All figures are collected from CCF 3-way unit with arc suppressor

#### End-of-life

ABB is committed to the protection of the environment and adheres to ISO 14001 standards. It is our obligation to facilitate end-of-life recycling for our products.

There exist no explicit requirements for how to handle discarded switchgears at end-of-life.

ABB's recycling service is according to IEC 1634 edition 1995 section 6: «End of life of SF<sub>6</sub> filled equipment» and in particular 6.5.2.a: «Low decomposition»: «No special action is required; non-recoverable parts can be disposed of normally according to local regulations.»

We also recommend ABB's website: <http://www.abb.com/sf6>

ABB AS, Power Products Division in Skien is equipped to reclaim SF<sub>6</sub> gas from discarded switchgears.

# Contact us

ABB AS  
Electrification Products division  
Medium Voltage  
P.O.Box 108, Sentrum  
N-3701 Skien, Norway  
Phone: +47 35 58 20 00  
[www.abb.com](http://www.abb.com)

Text and illustrations are not  
binding. The right to make alterations  
is reserved

Copyright© 2016 ABB  
All rights reserved

1VDD006104 GB rev February 2016

Power and productivity  
for a better world™

