



Short form catalogue

Motor protection & control up to 18.5 kW / 20 hp
Manual motor starters, contactors,
overload relays & softstarters

Motor Protection and Control up to 18.5 kW / 20 hp



Overview 2

Motor Starting Solutions - Open Type Version, in Kit Form..... 11

Manual Motor Starters, Contactors, Overload Relays,
Contactor Relays and Softstarters 43

Index 88

ABB's new control and protection devices

One product family

ABB presents a new generation of first-class specialized components: manual motor starters, contactors, overload relays and softstarters for motor starting solutions up to 18.5 kW / 20 hp

- Harmonized design & colour
- Compact and modular
- Low energy consumption
- Small number of parts
- Minimum need for accessories
- Optimized wiring and configuration
- High ratings and service capability
- Increased application possibilities
- Reliability proven over many years of experience



Simplicity for your design

Our engineers have taken modularity and uniformity to the next level in terms of flexibility and practicality for your applications. We offer you flexibility, increased application possibilities, exchangeability and reduced panel size.



Safety and reliability

ABB's new line of industrial motor control and protection devices has been developed in order to meet the main safety standards of the toughest industrial scenarios where high reliability and safety level are required.

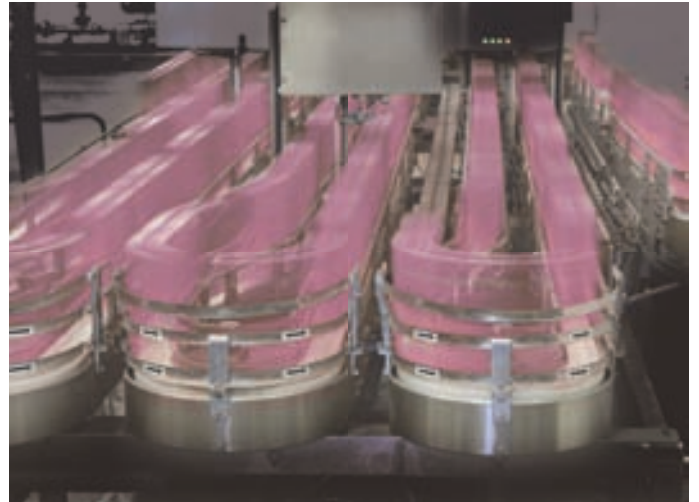

Increased availability for your equipment

Designing with simplicity in mind, our engineers have made it possible to integrate the entire family into just a few components. We offer you reduced inventory, greater exchangeability, to help you to have fewer mistakes and shortages and less down time.



Energy efficiency and sustainability

Reducing energy consumption and protecting the environment has long been at the top of ABB's list of priorities, and we are proud to introduce a first-class proposal.



Large choice of starting solutions in kit form

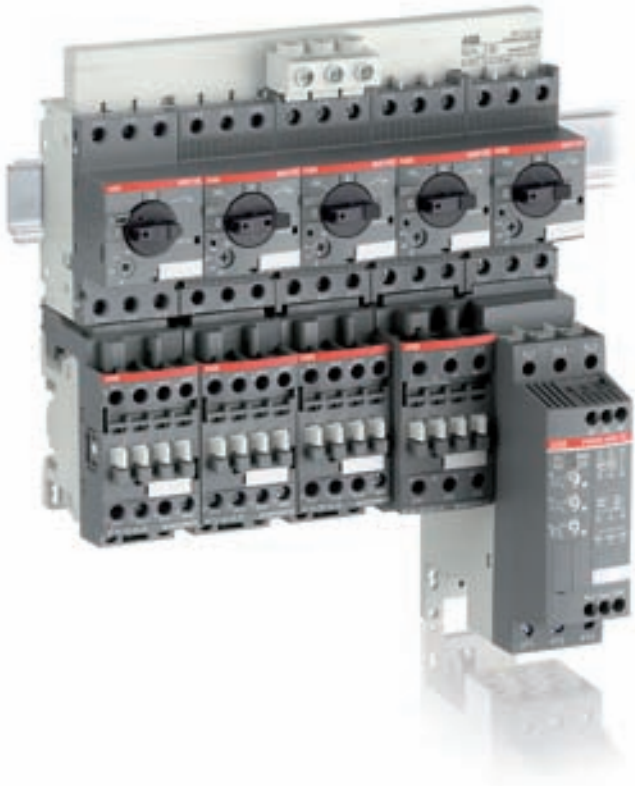

Short-circuit and overload protection

- Type 1 or type 2 coordination guaranteed with manual motor starters
- Choice of thermal or electronic overload relays

Simple construction

- All starters in 45 mm width module

Time/cost saving

- Same frame size for AC or DC control supply
- Easy, fast and secure assembly, fitting and wiring of components

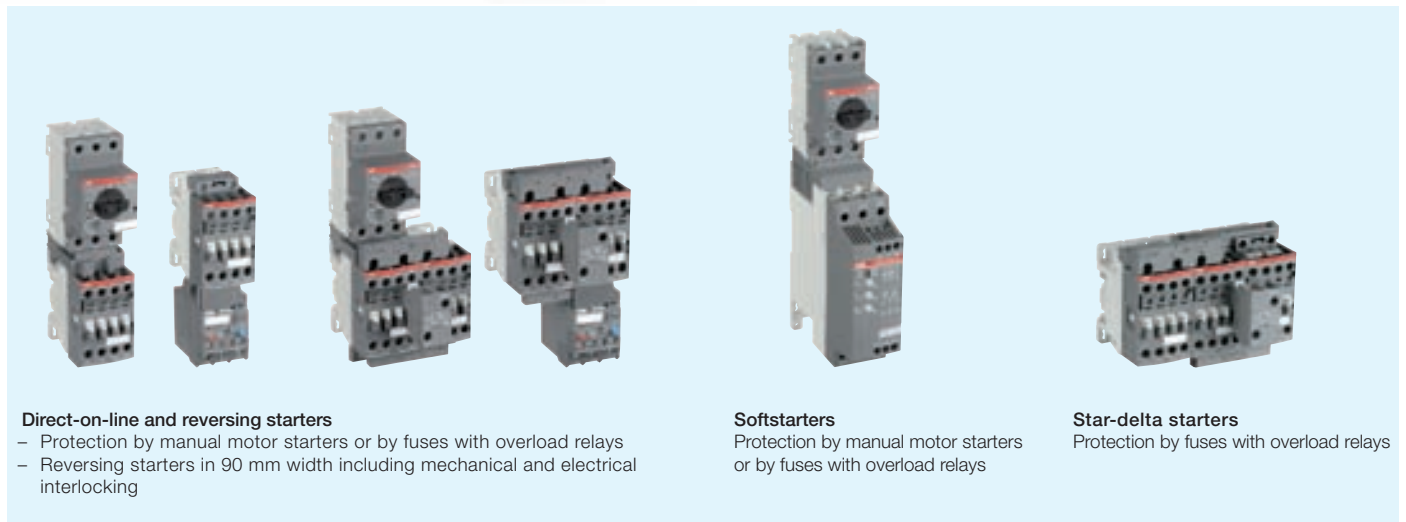

Direct-on-line and reversing starters

- Protection by manual motor starters or by fuses with overload relays
- Reversing starters in 90 mm width including mechanical and electrical interlocking

Softstarters

- Protection by manual motor starters or by fuses with overload relays

Star-delta starters

- Protection by fuses with overload relays

Standardized busbars and optimized interconnection accessories

- Same 3-phase busbar and feeder range up to 100 A for manual motor starters
- Direct 35 mm rail mounting: no additional mounting plate required
- Complete range of connection links with manual motor starters and connection sets to build reversing and star-delta starters
- Easy installation and dismantling of contactors: no unwiring of manual motor starters





Protect your motors with thermal or electronic overload relays

- One range of TF42 thermal overload relays, trip class 10
- One range of EF19 and EF45 electronic overload relays up to 45 A, 7 setting ranges, trip class 10E, 20E, 30E
- Adjustable current setting ranges
- Overload protection with phase loss sensitivity
- Temperature compensation:
 - up to +60 °C for thermal overload relays
 - up to +70 °C for electronic overload relays
- Automatic or manual reset, sealable
- Stop and test function

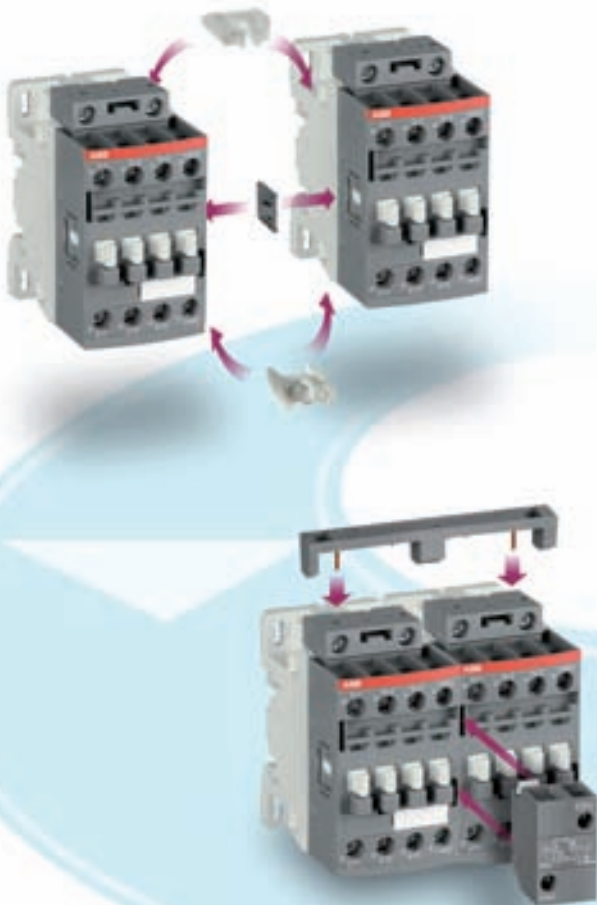
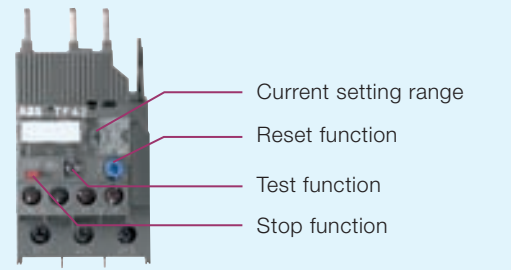
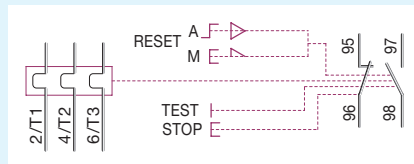

Interlock your reversing contactors quickly in 90 mm width:

- Easy with VM4 mechanical interlock unit
- Simple with VEM4 set including mechanical interlock unit and electrical interlock block with A2-A2 connection
- 50% wiring cost savings in one click!

Fixing the electrical interlock block to the contactor front face connects the 2 built-in N.C. interlocking contacts with the two coil supplies

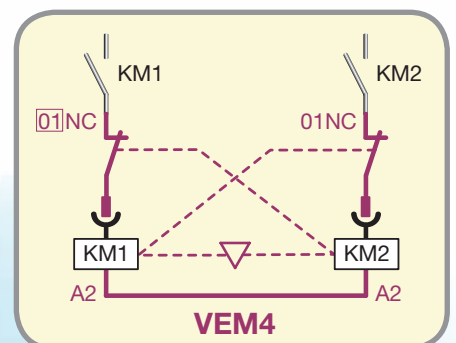

MS116 and MS132 manual motor starters

Harmonized design in 45 mm width



Types	MS116	MS132
Setting range	0.1 ... 16 A	0.1 ... 32 A
Switch position	ON / OFF	ON / OFF / TRIP
Magnetic trip indication	–	yes
Lockable handle without accessories	–	yes
Max. breaking capacity I_{cs}	up to 50 kA	up to 100 kA
Trip class	10A	10

ON/OFF switch functionality

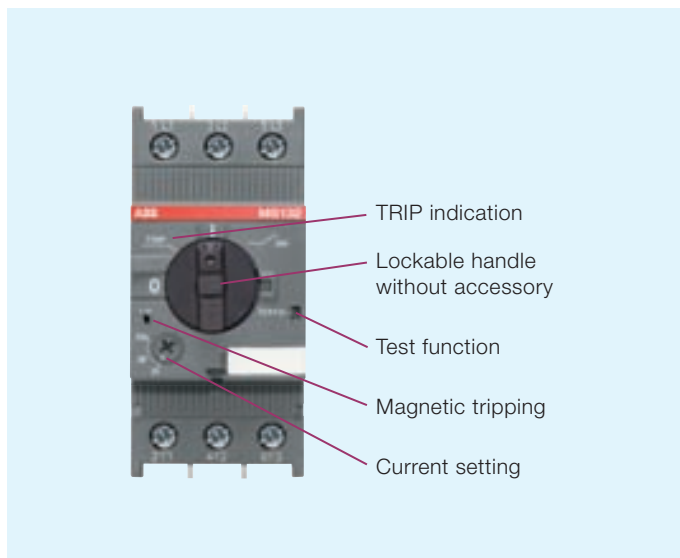

Clear tripping identification

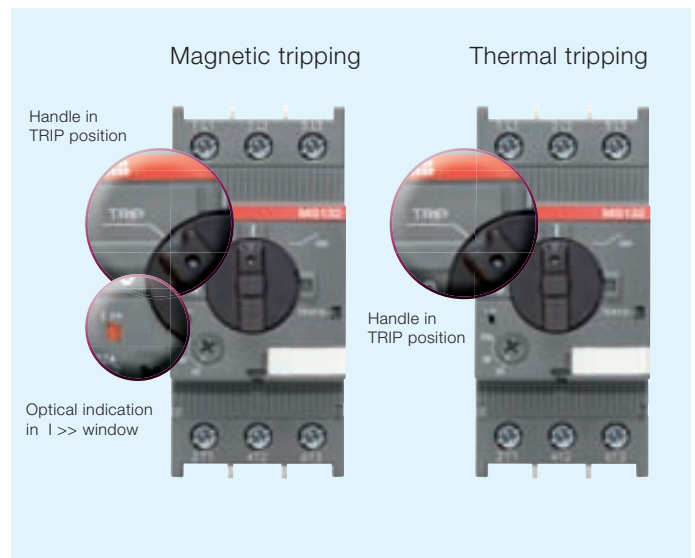

One range of accessories for MS116 and MS132

- Common auxiliary contacts, signaling contacts and auxiliary trip units
- Common busbar systems

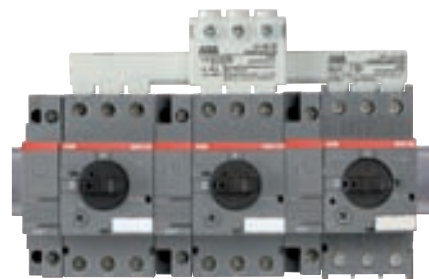

AF09 ... AF38 3-pole contactors

Simple design with 2 frame sizes in 45 mm width



Types	AF09	AF12	AF16	AF26	AF30	AF38
Rated operational power 400 V AC-3	4 kW	5.5 kW	7.5 kW	11 kW	15 kW	18.5 kW
Rated operational current AC-1 (40 °C)	25 A	28 A	30 A	45 A	50 A	50 A
UL 3-phase motor power 480 V	5 hp	7.5 hp	10 hp	15 hp	20 hp	20 hp

A unique contactor for AC or DC control supply

- Manages large control voltage variations
- Includes an electronic coil interface with extended operating limits $0.85 \times U_c$ min. ... $1.1 \times U_c$ max.

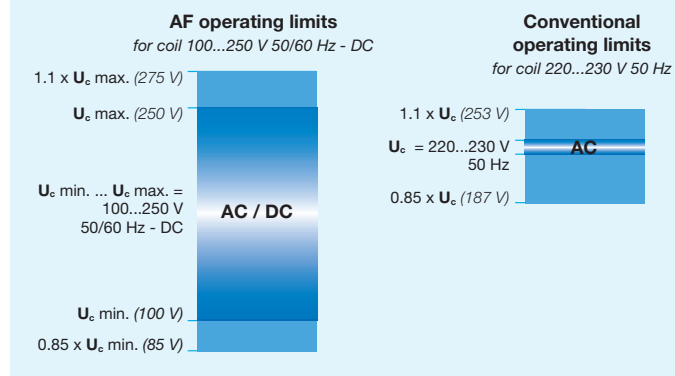

Only four coils for easier selection

Control voltages covering 24...500 V 50/60 Hz and 20...500 V DC

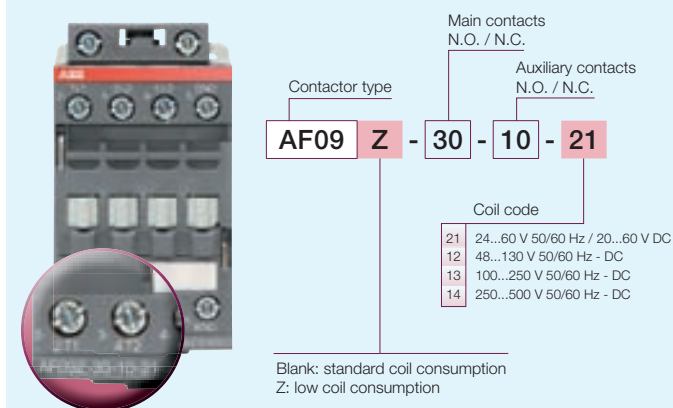

Reduced panel energy consumption

- With low holding AC and DC coil consumption
- From 30% (AF coil) to 80% (AF..Z coil) reduction of AC pull-in consumption

Built-in surge protection

- No extra surge suppressor required

Improve your equipment reliability with AF..Z contactors

- Withstands control voltage short dips
- Withstands control voltage sags according to SEMI F47-0706 standards
- Additional AF..Z coils available for control voltages between 12...20 V DC and 48...250 V 50/60 Hz - DC

Direct control by PLC-output ≥ 500 mA, 24 V DC

No use of interface relay





Switching of auxiliary and control circuits



Optimize your auxiliary contact block configuration

- AF09...AF16 3-pole contactors equipped with a built-in auxiliary contact N.O. or N.C.
- Up to 6 additional auxiliary contacts:
 - front-mounted 1 or 4-pole CA4 blocks
 - side-mounted 2-pole CAL4 blocks
- Reduced panel dimension using up to 2 side-mounted 2-pole CAL4 blocks

Make your control circuit safe

- **Mirror contact**  according to IEC 60947-4-1 Annex F 2.1
- **Mechanically linked contacts**  according to IEC 60947-5-1 Annex L 3.0

Free choice of your coil terminal access

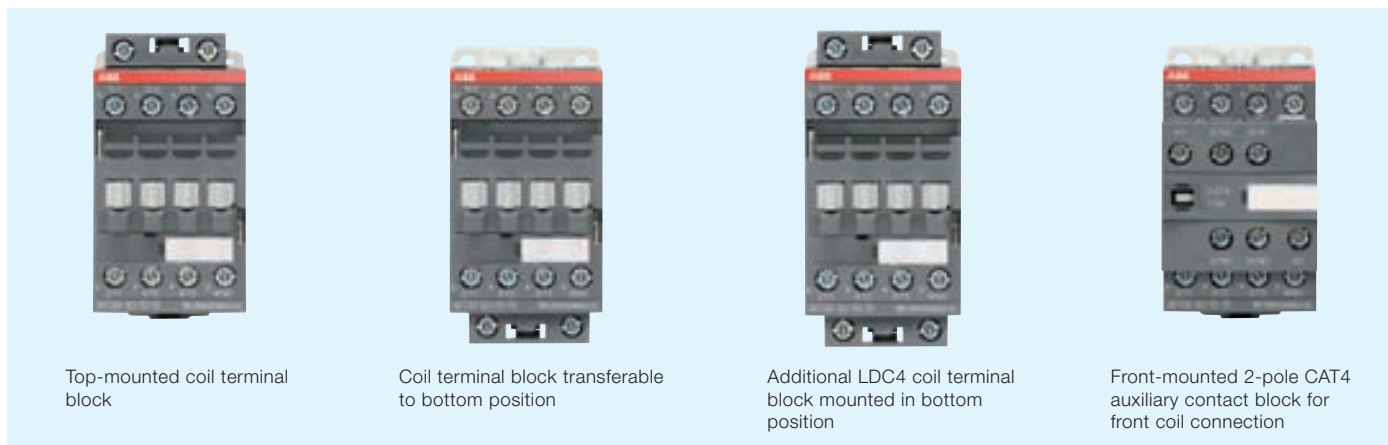

Top-mounted coil terminal block

Coil terminal block transferable to bottom position

Additional LDC4 coil terminal block mounted in bottom position

Front-mounted 2-pole CAT4 auxiliary contact block for front coil connection

Protect your equipment against accidental contact



Sealable and transparent protective covers on contactors (BX4) and overload relays

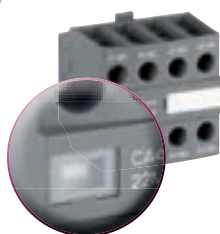

Non-removable protective covers (BX4-CA) for auxiliary contact blocks

Complete choice of contactor relays

- Same advantages and accessories as AF contactors
- Only four coils for easier selection

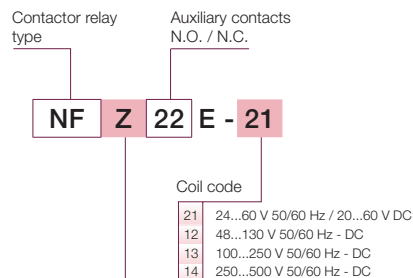
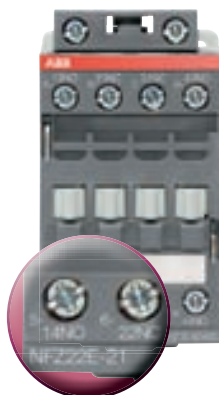

Blank: standard coil consumption
Z: low coil consumption

PSR softstarters

Compact design with 3 frame sizes



Types	PSR3 ... PSR16	PSR25, PSR30	PSR37
Rated operational power 400 V AC-53a	1.5 ... 7.5 kW	11 ... 15 kW	18.5 kW
UL 3-phase motor power - 480 V	2 ... 10 hp	15 ... 20 hp	25 hp

- Built-in by-pass contacts in main circuit
- Wide main voltage range: from 208 to 600 V
 - fewer variants
 - very robust and insensitive to voltage variations
- Wide supply voltage range: 100 ... 240 V AC or 24 V DC

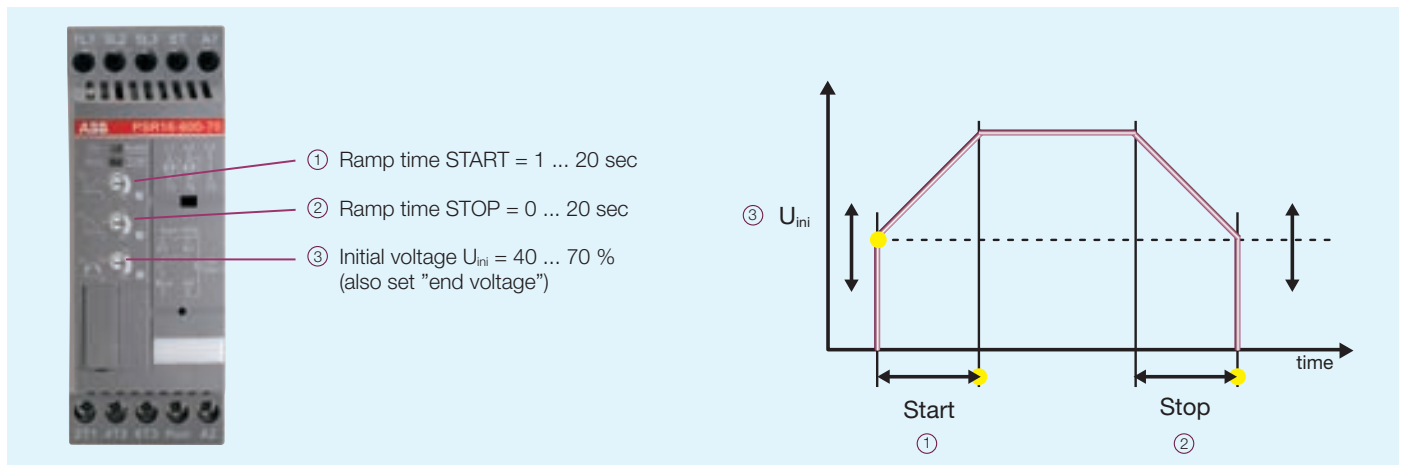

Easy to install and set up

- 35 mm rail or screw mounting
- All settings visible and adjustable on front face
- Run signal relay for all sizes
- Output signal for TOR (Top Of Ramp) for PSR25...PSR37
- 10 starts per hour standard, increased to 20 starts or more with addition of auxiliary cooling fan
- Remote control connection using Field Bus Plug as accessory

Compact starter solution in 45 mm width with manual motor starter up to 15 kW - 400 V

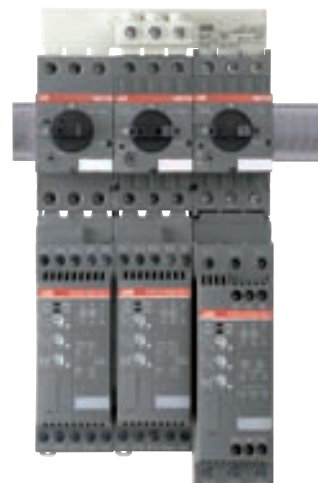

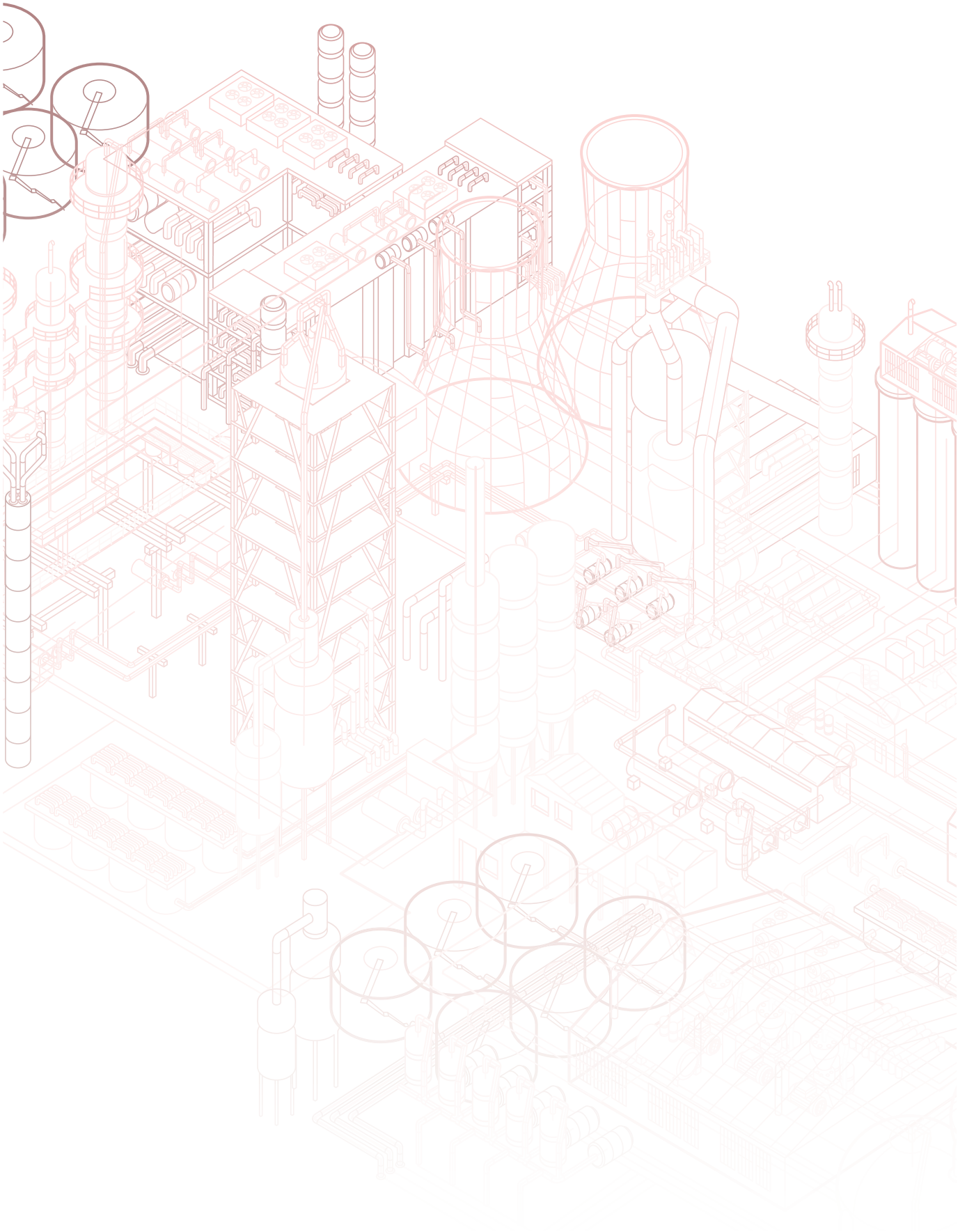

Motor Starting Solutions

Open Type Version, in Kit Form



Starters Protected by Manual Motor Starters

Overview	12
Direct-On-Line Starters	14
Reversing Starters	18
Dimensions	22

Starters Protected by Thermal Overload Relays

Overview	12
Direct-On-Line Starters	26
Reversing Starters	26
Star-Delta Starters	30
Dimensions	34

Softstarters Protected by Manual Motor Starters

Overview	36
Softstarters	37
Dimensions	40

Motor Starting Solutions Open Type Version, in Kit Form

Starters Protected by Manual Motor Starters

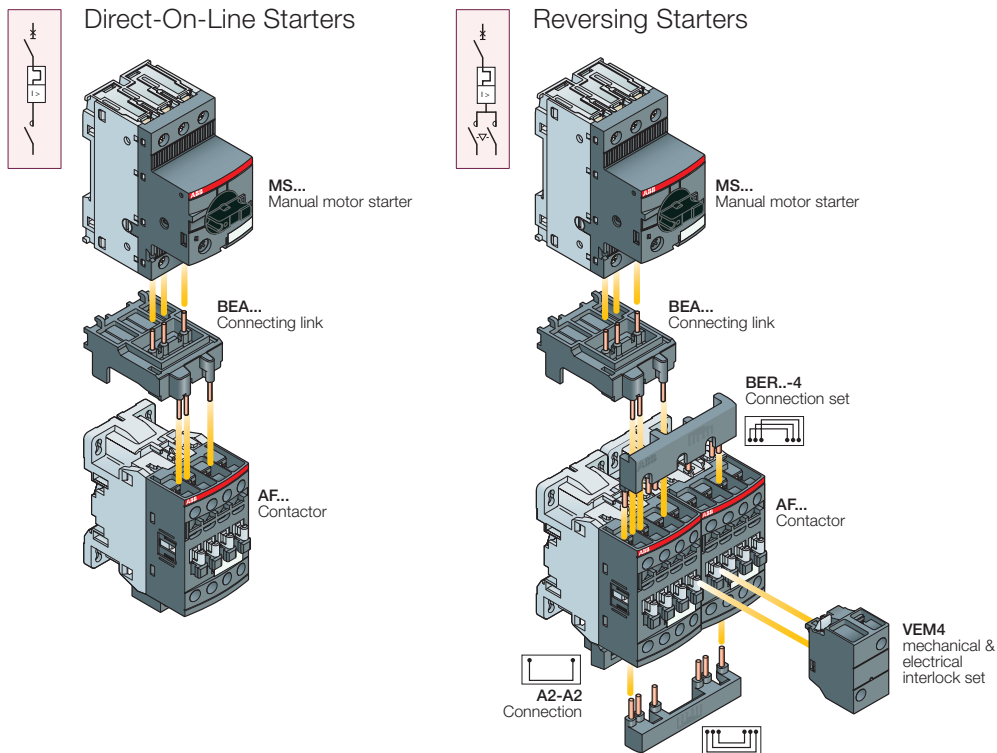

Starters Protected by Thermal Overload Relays

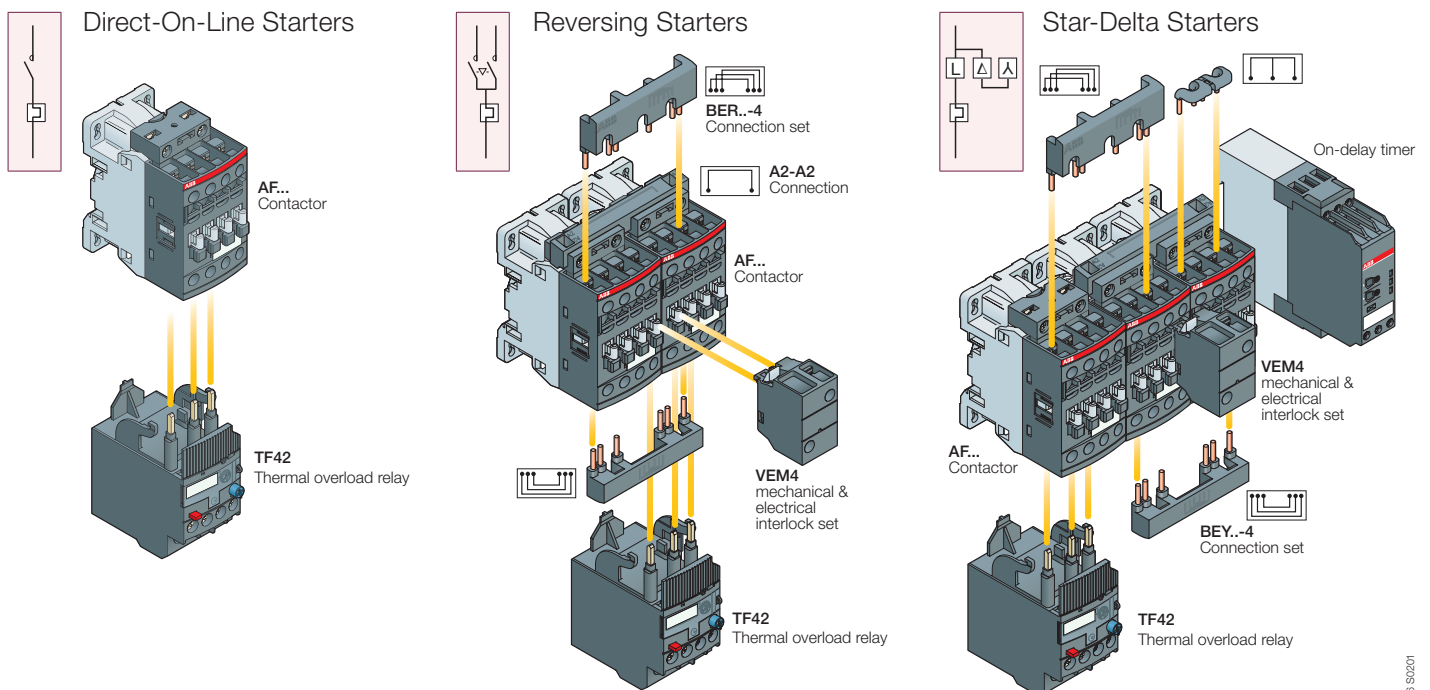

VEM4 mechanical and electrical interlock set including: VM4 mechanical interlock unit including 2 fixing clips and VE4 electrical interlock block with A2-A2 connection

Starters Protected by Manual Motor Starters



Switching of 3-phase Cage Motors

	Direct-On-Line Starters	Reversing Starters
Rated power - AC-3, 400 V	0.06 ... 15 kW	0.06 ... 15 kW
Short-circuit current I _n	16 kA - 50 kA	16 kA - 50 kA
Coordination type	Type 1 & type 2	Type 1 & type 2
Manual motor starters	MS116 ... MS132	MS116 ... MS132
Contactors	AF09 ... AF30	AF09 ... AF30

Starters Protected by Thermal Overload Relays

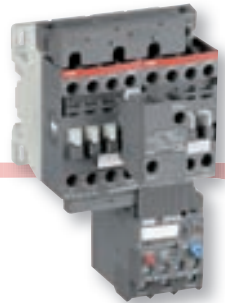

Switching of 3-phase Cage Motors

	Direct-On-Line Starters	Reversing Starters
Rated power - AC-3, 400 V	4 ... 18.5 kW	4 ... 18.5 kW
Contactors	AF09 ... AF38	AF09 ... AF38
Thermal overload relays	TF42	TF42



Switching of 3-phase Cage Motors

	Star-Delta Starters
Rated power - AC-3, 400 V	7.5 ... 25 kW
Contactors	AF09 ... AF38
Thermal overload relays	TF42

Direct-On-Line Starters Protected by Manual Motor Starters With AF Contactors - Open Type Version in Kit Form



MS132-10 + BEA16-4 + AF16-30-10

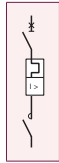

Application

Full voltage direct-on-line starting for controlling three-phase asynchronous motors is a simple and economic solution characterised by a high starting torque (1.9 to 2.1 times full-speed torque) and a starting current 5.5 to 7 times nominal current.

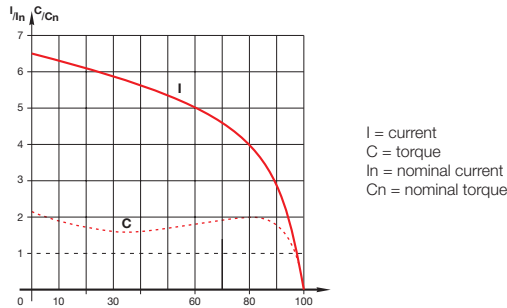

Coordination Types

The contactor and the manual motor starter control and protect motors against overload and short-circuits according to coordination types 1 and 2 (IEC 60947-4-1 / EN 60947-4-1) defining the anticipated level of service continuity as follow:

Type 1: In short-circuit conditions, the contactor or starter does not endanger persons or installations and will not be able to then operate without being repaired or having parts replaced.

Type 2: In short-circuit conditions, the contactor or starter does not endanger persons or installations and will be able to operate afterwards. The risk of contacts light welding is acceptable.

Main Technical Data

Standards	IEC 60947-4-1 / EN 60947-4-1	
Rated operational voltage U_e max.	690 V - 50/60 Hz	
Rated insulation voltage U_i according to IEC 60947-4-1	690 V	
Switching frequency	≤ 15 starts/hour - 80 % max. load factor - with max. 1.5 s starting time	
	≤ 30 starts/hour - 50 % max. load factor - with max. 1.5 s starting time	
Ambient air temperature close to the device	use with MS116	≤ 55 °C
	use with MS132	≤ 60 °C
Degree of protection	IP 20	

Mounting positions

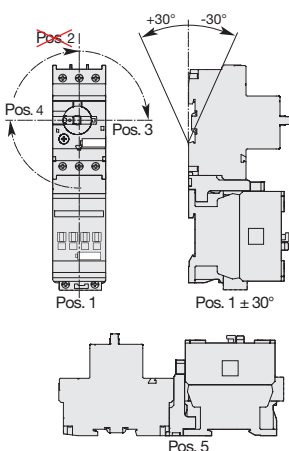

Direct-On-Line Starters Protected by Manual Motor Starters With AF Contactors - Open Type Version in Kit Form

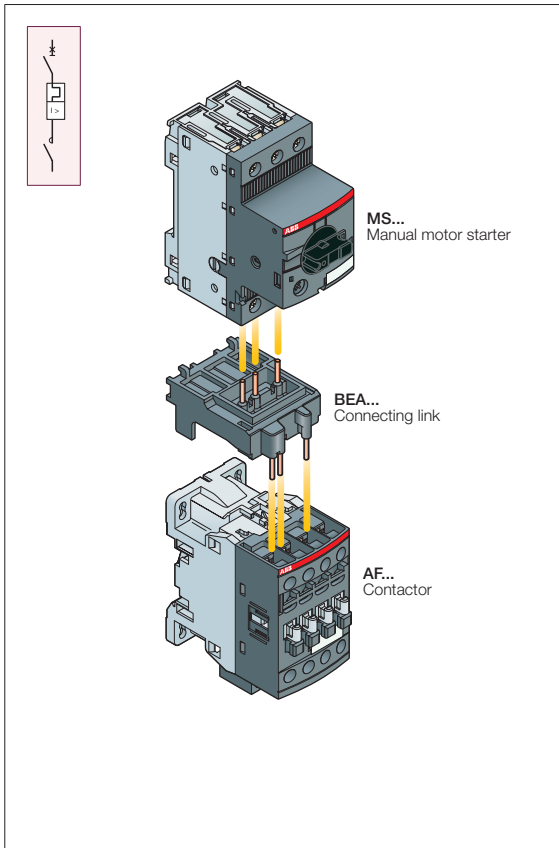

Description

You can easily assemble a direct-on-line starter by using the BEA...-4 connecting link 3-pole insulated. It is used to electrically and mechanically connect MS... manual motor starter and AF... contactor, AC or DC operated.

Select now easily and quickly your starter in the following pages for coordination type 1 or 2 at 400 V, 50 / 60 Hz, $I_q = 16$ kA or $I_q = 50$ kA up to 15 kW.

For complete coordination tables, please contact your ABB local sales organization.

Wiring Diagrams

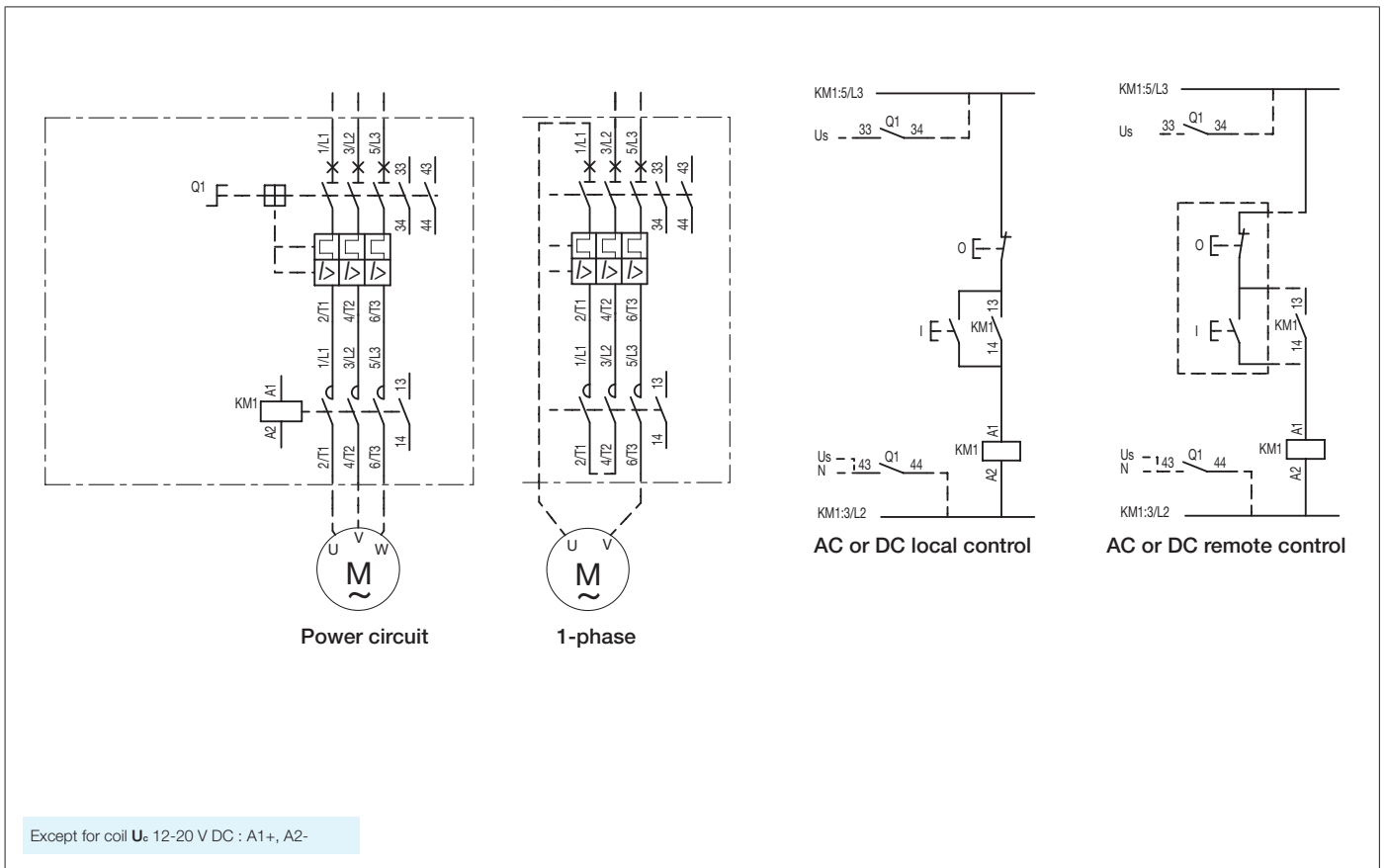

DOL Starters Protected by MS132 Manual Motor Starters

Coordination Type 1

Catalogue Page 1SBC 101 256 S0201



Coordination Type 1, AC-3, 16 kA or 50 kA, 400 V, 50/60 Hz

Manual motor starters					Contactors					Accessories	
IEC AC-3, 400 V Rated power kW	Rated current A	Type (1)	Order code	Current setting range A	Magnetic tripping current A	Control voltage U _{min} ... U _{max} (2) V 50/60 Hz V DC	Type	Order code	Allowed setting current A	Type	Order code

I_q = 16 kA

I_q = 50 kA

0.06	0.2	MS132-0.25	1SAM 350 000 R1002	0.16...0.25	2.44	24...60 20...60	AF09Z-30-10-21	1SBL 136 001 R2110	0.25	BEA16-4	1SBN 081 306 T1000
						100...250 100...250	AF09-30-10-13	1SBL 137 001 R1310			
0.09	0.3	MS132-0.4	1SAM 350 000 R1003	0.25...0.40	3.9	24...60 20...60	AF09Z-30-10-21	1SBL 136 001 R2110	0.4		
						100...250 100...250	AF09-30-10-13	1SBL 137 001 R1310			
0.12	0.44	MS132-0.63	1SAM 350 000 R1004	0.40...0.63	6.14	24...60 20...60	AF09Z-30-10-21	1SBL 136 001 R2110	0.63		
						100...250 100...250	AF09-30-10-13	1SBL 137 001 R1310			
0.18	0.6	MS132-0.63	1SAM 350 000 R1004	0.40...0.63	6.14	24...60 20...60	AF09Z-30-10-21	1SBL 136 001 R2110	0.63		
						100...250 100...250	AF09-30-10-13	1SBL 137 001 R1310			
0.25	0.85	MS132-1.0	1SAM 350 000 R1005	0.63...1.00	11.5	24...60 20...60	AF09Z-30-10-21	1SBL 136 001 R2110	1		
						100...250 100...250	AF09-30-10-13	1SBL 137 001 R1310			
0.37	1.1	MS132-1.6	1SAM 350 000 R1006	1.00...1.60	18.4	24...60 20...60	AF09Z-30-10-21	1SBL 136 001 R2110	1.6		
						100...250 100...250	AF09-30-10-13	1SBL 137 001 R1310			
0.55	1.5	MS132-1.6	1SAM 350 000 R1006	1.00...1.60	18.4	24...60 20...60	AF09Z-30-10-21	1SBL 136 001 R2110	1.6		
						100...250 100...250	AF09-30-10-13	1SBL 137 001 R1310			
0.75	1.9	MS132-2.5	1SAM 350 000 R1007	1.60...2.50	28.75	24...60 20...60	AF09Z-30-10-21	1SBL 136 001 R2110	2.5		
						100...250 100...250	AF09-30-10-13	1SBL 137 001 R1310			
1.1	2.7	MS132-4.0	1SAM 350 000 R1008	2.50...4.00	50	24...60 20...60	AF09Z-30-10-21	1SBL 136 001 R2110	4		
						100...250 100...250	AF09-30-10-13	1SBL 137 001 R1310			
1.5	3.6	MS132-4.0	1SAM 350 000 R1008	2.50...4.00	50	24...60 20...60	AF09Z-30-10-21	1SBL 136 001 R2110	4		
						100...250 100...250	AF09-30-10-13	1SBL 137 001 R1310			
2.2	4.9	MS132-6.3	1SAM 350 000 R1009	4.00...6.30	78.75	24...60 20...60	AF09Z-30-10-21	1SBL 136 001 R2110	6.3		
						100...250 100...250	AF09-30-10-13	1SBL 137 001 R1310			
3	6.5	MS132-10	1SAM 350 000 R1010	6.30...10.0	150	24...60 20...60	AF09Z-30-10-21	1SBL 136 001 R2110	9		
						100...250 100...250	AF09-30-10-13	1SBL 137 001 R1310			
4	8.5	MS132-10	1SAM 350 000 R1010	6.30...10.0	150	24...60 20...60	AF09Z-30-10-21	1SBL 136 001 R2110	9		
						100...250 100...250	AF09-30-10-13	1SBL 137 001 R1310			
5.5	11.5	MS132-12	1SAM 350 000 R1012	8.00...12.0	180	24...60 20...60	AF12Z-30-10-21	1SBL 156 001 R2110	12		
						100...250 100...250	AF12-30-10-13	1SBL 157 001 R1310			
7.5	15.5	MS132-16	1SAM 350 000 R1011	10.0...16.0	240	24...60 20...60	AF16Z-30-10-21	1SBL 176 001 R2110	16		
						100...250 100...250	AF16-30-10-13	1SBL 177 001 R1310			
11	22	MS132-25	1SAM 350 000 R1014	20.0...25.0	375	24...60 20...60	AF26Z-30-00-21	1SBL 236 001 R2100	25	BEA38-4 + CA4-10	1SBN 082 306 T2000 + 1SBN 010 110 R1010
						100...250 100...250	AF26-30-00-13	1SBL 237 001 R1300			
15	29	MS132-32	1SAM 350 000 R1015	25.0...32.0	480	24...60 20...60	AF30Z-30-00-21	1SBL 276 001 R2100	32		
						100...250 100...250	AF30-30-00-13	1SBL 277 001 R1300			

(1) MS116 manual motor starter can be selected according to the current setting range indicated on the coordination line, up to:

- 7.5 kW, 400 V - AC-3 at 16 kA
- 4 kW, 400 V - AC-3 at 50 kA.

(2) For other control voltages, see "3-pole contactors - Ordering details" pages.

DOL Starters Protected by MS132 Manual Motor Starters Coordination Type 2



Coordination Type 2, AC-3, 16 kA or 50 kA, 400 V, 50/60 Hz

Manual motor starters				Contactors				Accessories			
IEC AC-3, 400 V Rated power kW	Type (1)	Order code	Current setting range A	Magnetic tripping current A	Control voltage U: min. ... U: max. (2) V 50/60 Hz, V DC	Type (3)	Order code	Allowed setting current A	Type (4)	Order code	

I_q = 16 kA

I_q = 50 kA

0.06	0.2	MS132-0.25	1SAM 350 000 R1002	0.16...0.25	2.44	24...60	20...60	AF09Z-30-10-21	1SBL 136 001 R2110	0.25	BEA16-4	1SBN 081 306 T1000
						100...250	100...250	AF09-30-10-13	1SBL 137 001 R1310			
0.09	0.3	MS132-0.4	1SAM 350 000 R1003	0.25...0.40	3.9	24...60	20...60	AF09Z-30-10-21	1SBL 136 001 R2110	0.4		
						100...250	100...250	AF09-30-10-13	1SBL 137 001 R1310			
0.12	0.44	MS132-0.63	1SAM 350 000 R1004	0.40...0.63	6.14	24...60	20...60	AF09Z-30-10-21	1SBL 136 001 R2110	0.63		
						100...250	100...250	AF09-30-10-13	1SBL 137 001 R1310			
0.18	0.6	MS132-0.63	1SAM 350 000 R1004	0.40...0.63	6.14	24...60	20...60	AF09Z-30-10-21	1SBL 136 001 R2110	0.63		
						100...250	100...250	AF09-30-10-13	1SBL 137 001 R1310			
0.25	0.85	MS132-1.0	1SAM 350 000 R1005	0.63...1.00	11.5	24...60	20...60	AF09Z-30-10-21	1SBL 136 001 R2110	1		
						100...250	100...250	AF09-30-10-13	1SBL 137 001 R1310			
0.37	1.1	MS132-1.6	1SAM 350 000 R1006	1.00...1.60	18.4	24...60	20...60	AF09Z-30-10-21	1SBL 136 001 R2110	1.6		
						100...250	100...250	AF09-30-10-13	1SBL 137 001 R1310			
0.55	1.5	MS132-1.6	1SAM 350 000 R1006	1.00...1.60	18.4	24...60	20...60	AF09Z-30-10-21	1SBL 136 001 R2110	1.6		
						100...250	100...250	AF09-30-10-13	1SBL 137 001 R1310			
0.75	1.9	MS132-2.5	1SAM 350 000 R1007	1.60...2.50	28.75	24...60	20...60	AF09Z-30-10-21	1SBL 136 001 R2110	2.5		
						100...250	100...250	AF09-30-10-13	1SBL 137 001 R1310			
1.1	2.7	MS132-4.0	1SAM 350 000 R1008	2.50...4.00	50	24...60	20...60	AF26Z-30-00-21	1SBL 236 001 R2100	4	BEA26-4	1SBN 082 306 T1000
						100...250	100...250	AF26-30-00-13	1SBL 237 001 R1300		+ CA4-10	+ 1SBN 010 110 R1010
1.5	3.6	MS132-4.0	1SAM 350 000 R1008	2.50...4.00	50	24...60	20...60	AF26Z-30-00-21	1SBL 236 001 R2100	4		
						100...250	100...250	AF26-30-00-13	1SBL 237 001 R1300			
2.2	4.9	MS132-6.3	1SAM 350 000 R1009	4.00...6.30	78.75	24...60	20...60	AF26Z-30-00-21	1SBL 236 001 R2100	6.3		
						100...250	100...250	AF26-30-00-13	1SBL 237 001 R1300			
3	6.5	MS132-10	1SAM 350 000 R1010	6.30...10.0	150	24...60	20...60	AF26Z-30-00-21	1SBL 236 001 R2100	10		
						100...250	100...250	AF26-30-00-13	1SBL 237 001 R1300			
4	8.5	MS132-10	1SAM 350 000 R1010	6.30...10.0	150	24...60	20...60	AF26Z-30-00-21	1SBL 236 001 R2100	10		
						100...250	100...250	AF26-30-00-13	1SBL 237 001 R1300			
5.5	11.5	MS132-12	1SAM 350 000 R1012	8.00...12.0	180	24...60	20...60	AF26Z-30-00-21	1SBL 236 001 R2100	12	BEA38-4	1SBN 082 306 T2000
						100...250	100...250	AF26-30-00-13	1SBL 237 001 R1300		+ CA4-10	+ 1SBN 010 110 R1010
7.5	15.5	MS132-16	1SAM 350 000 R1011	10.0...16.0	240	24...60	20...60	AF30Z-30-00-21	1SBL 276 001 R2100	16		
						100...250	100...250	AF30-30-00-13	1SBL 277 001 R1300			
11	22	MS132-25	1SAM 350 000 R1014	20.0...25.0	375	24...60	20...60	AF30Z-30-00-21	1SBL 276 001 R2100	25		
						100...250	100...250	AF30-30-00-13	1SBL 277 001 R1300			
15	29	MS132-32	1SAM 350 000 R1015	25.0...32.0	480	24...60	20...60	AF30Z-30-00-21	1SBL 276 001 R2100	32		
						100...250	100...250	AF30-30-00-13	1SBL 277 001 R1300			

(1) MS116 manual motor starter can be selected according to the current setting range indicated on the coordination line, up to:

- 7.5 kW, 400 V - AC-3 at 16 kA
- 4 kW, 400 V - AC-3 at 50 kA.

(2) For other control voltages, see "3-pole contactors - Ordering details" pages.

(3) AF26... 3-pole contactor can be selected for coordination type 2, 16 kA, 7.5 kW, 400 V - AC-3.

(4) BEA38-4 cannot be selected with MS116 manual motor starters.

Reversing Starters Protected by Manual Motor Starters With AF Contactors - Open Type Version in Kit Form

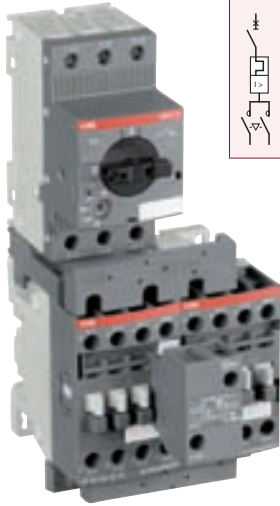

MS132-10 + BEA16-4 + BER16-4 + VEM4
+ AF16-30-10

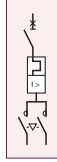

Application

Full voltage reversing starting for controlling three-phase asynchronous motors is a simple and economic solution characterised by a high starting torque (1.9 to 2.1 times full-speed torque) and a starting current 5.5 to 7 times nominal current.

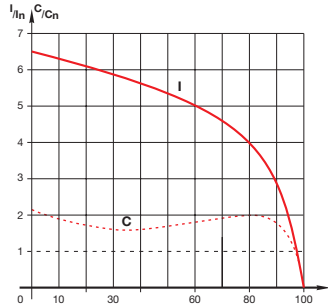

I = current
C = torque
I_n = nominal current
C_n = nominal torque

Coordination Types

The contactor and the manual motor starter control and protect motors against overload and short-circuits according to coordination types 1 and 2 (IEC 60947-4-1 / EN 60947-4-1) defining the anticipated level of service continuity as follow:

Type 1: In short-circuit conditions, the contactor or starter does not endanger persons or installations and will not be able to then operate without being repaired or having parts replaced.

Type 2: In short-circuit conditions, the contactor or starter does not endanger persons or installations and will be able to operate afterwards. The risk of contacts light welding is acceptable.

Main Technical Data

Standards	IEC 60947-4-1 / EN 60947-4-1	
Rated operational voltage U_o max.	690 V - 50/60 Hz	
Rated insulation voltage U_i according to IEC 60947-4-1	690 V	
Switching frequency	≤ 15 starts/hour - 80 % max. load factor - with max. 1.5 s starting time	
	≤ 30 starts/hour - 50 % max. load factor - with max. 1.5 s starting time	
Ambient air temperature close to the device	use with MS116	≤ 55 °C
	use with MS132	≤ 60 °C
Degree of protection	IP 20	

Mounting positions

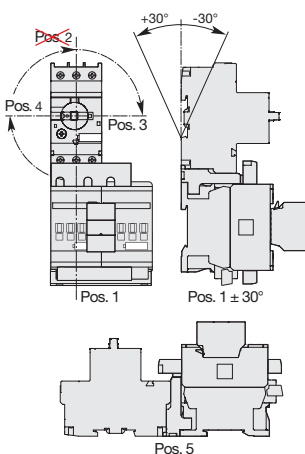

Reversing Starters Protected by Manual Motor Starters With AF Contactors - Open Type Version in Kit Form

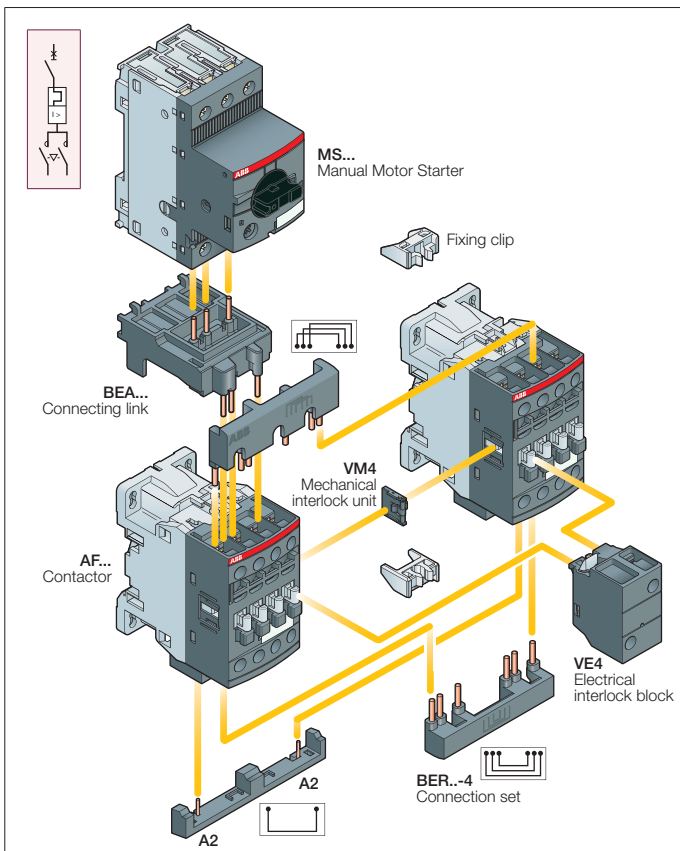

Description

You can easily assemble reversing starter thanks to our complete range of accessories:

- BEA...-4 connecting link 3-pole insulated: it is used to electrically and mechanically connect MS... manual motor starter and AF contactor, AC or DC operated.
- VEM4 mechanical and electrical interlock set for reversing starter in 90 mm width. It includes:
 - VM4 mechanical interlock unit including 2 fixing clips
 - VE4 electrical interlock block with A2-A2 connection.
- BER...-4 connection set: it assures a safe and simple reversing connection between both contactor main terminals.

Select now easily and quickly your starter in the following pages for coordination type 1 or 2 at 400 V, 50 / 60 Hz, $I_n = 16$ kA or $I_n = 50$ kA up to 15 kW.

For complete coordination tables, please contact your ABB local sales organization.

Wiring Diagrams

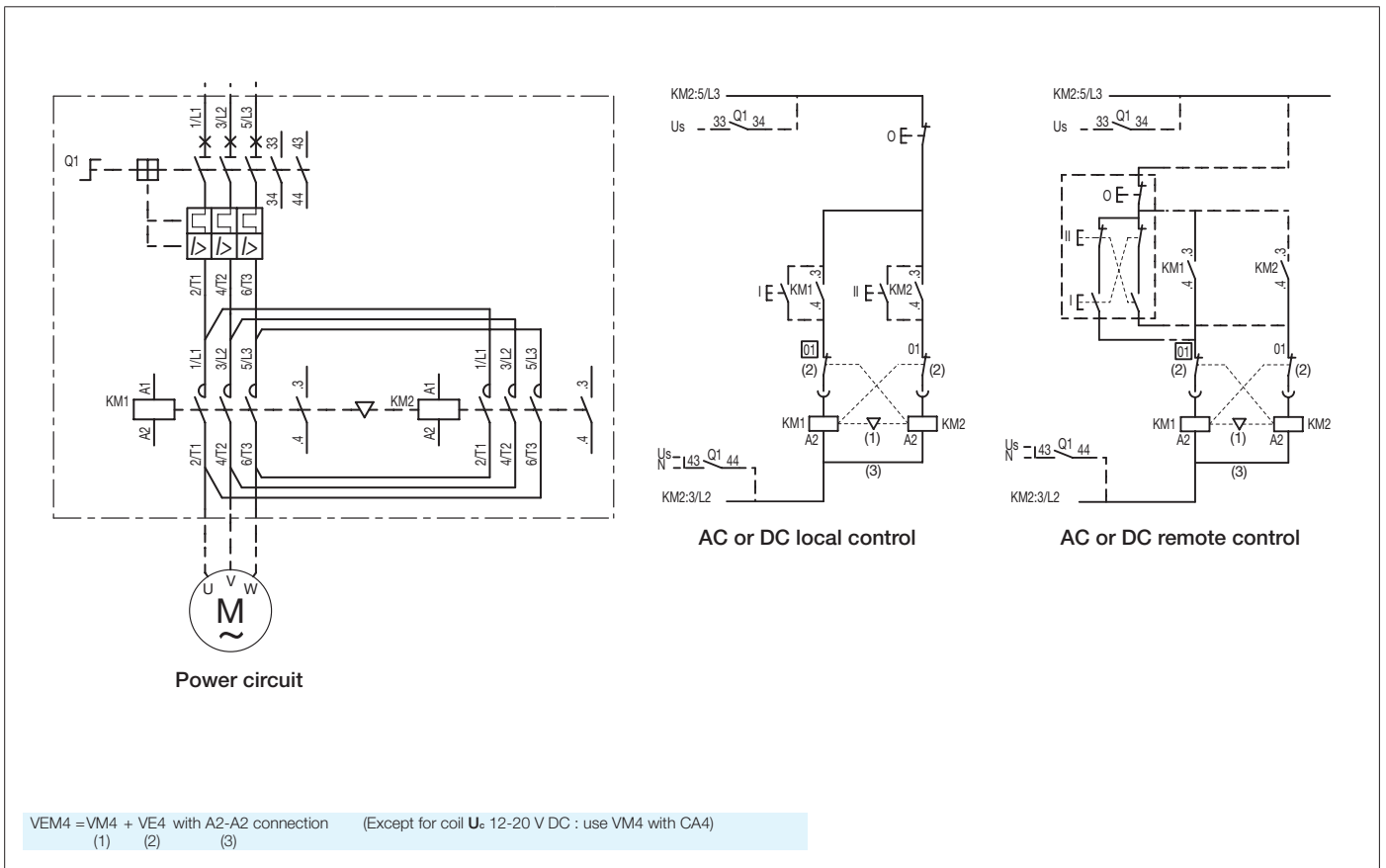

Reversing Starters Protected by MS132 Manual Motor Starters

Coordination Type 1

Catalogue Page 1SBC 101 258 S0201



Coordination Type 1, AC-3, 16 kA or 50 kA, 400 V, 50/60 Hz

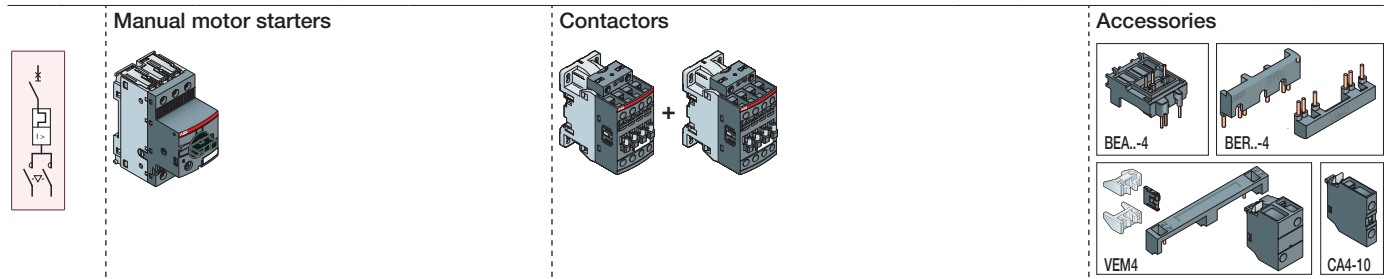

IEC	Type	Order code	Current setting range	Magnetic tripping current	Control voltage U _c min. ... U _c max.	Type	Order code	Allowed setting current	Type	Order code
AC-3, 400 V	(1)		A	A	V 50/60 Hz; V DC			A		
Rated power	Rated current									
kW	A									

I_q = 16 kA

I_q = 50 kA

0.06	0.2	MS132-0.25	1SAM 350 000 R1002	0.16...0.25	2.44	24...60	20...60	AF09Z-30-10-21	1SBL 136 001 R2110	0.25	BEA16-4	1SBN 081 306 T1000
						100...250	100...250	AF09-30-10-13	1SBL 137 001 R1310		+	
0.09	0.3	MS132-0.4	1SAM 350 000 R1003	0.25...0.40	3.9	24...60	20...60	AF09Z-30-10-21	1SBL 136 001 R2110	0.4	BER16-4	1SBN 081 311 R1000
						100...250	100...250	AF09-30-10-13	1SBL 137 001 R1310		+	
0.12	0.44	MS132-0.63	1SAM 350 000 R1004	0.40...0.63	6.14	24...60	20...60	AF09Z-30-10-21	1SBL 136 001 R2110	0.63	+	
						100...250	100...250	AF09-30-10-13	1SBL 137 001 R1310		VEM4	1SBN 030 111 R1000
0.18	0.6	MS132-0.63	1SAM 350 000 R1004	0.40...0.63	6.14	24...60	20...60	AF09Z-30-10-21	1SBL 136 001 R2110	0.63		
						100...250	100...250	AF09-30-10-13	1SBL 137 001 R1310			
0.25	0.85	MS132-1.0	1SAM 350 000 R1005	0.63...1.00	11.5	24...60	20...60	AF09Z-30-10-21	1SBL 136 001 R2110	1		
						100...250	100...250	AF09-30-10-13	1SBL 137 001 R1310			
0.37	1.1	MS132-1.6	1SAM 350 000 R1006	1.00...1.60	18.4	24...60	20...60	AF09Z-30-10-21	1SBL 136 001 R2110	1.6		
						100...250	100...250	AF09-30-10-13	1SBL 137 001 R1310			
0.55	1.5	MS132-1.6	1SAM 350 000 R1006	1.00...1.60	18.4	24...60	20...60	AF09Z-30-10-21	1SBL 136 001 R2110	1.6		
						100...250	100...250	AF09-30-10-13	1SBL 137 001 R1310			
0.75	1.9	MS132-2.5	1SAM 350 000 R1007	1.60...2.50	28.75	24...60	20...60	AF09Z-30-10-21	1SBL 136 001 R2110	2.5		
						100...250	100...250	AF09-30-10-13	1SBL 137 001 R1310			
1.1	2.7	MS132-4.0	1SAM 350 000 R1008	2.50...4.00	50	24...60	20...60	AF09Z-30-10-21	1SBL 136 001 R2110	4		
						100...250	100...250	AF09-30-10-13	1SBL 137 001 R1310			
1.5	3.6	MS132-4.0	1SAM 350 000 R1008	2.50...4.00	50	24...60	20...60	AF09Z-30-10-21	1SBL 136 001 R2110	4		
						100...250	100...250	AF09-30-10-13	1SBL 137 001 R1310			
2.2	4.9	MS132-6.3	1SAM 350 000 R1009	4.00...6.30	78.75	24...60	20...60	AF09Z-30-10-21	1SBL 136 001 R2110	6.3		
						100...250	100...250	AF09-30-10-13	1SBL 137 001 R1310			
3	6.5	MS132-10	1SAM 350 000 R1010	6.30...10.0	150	24...60	20...60	AF09Z-30-10-21	1SBL 136 001 R2110	9		
						100...250	100...250	AF09-30-10-13	1SBL 137 001 R1310			
4	8.5	MS132-10	1SAM 350 000 R1010	6.30...10.0	150	24...60	20...60	AF09Z-30-10-21	1SBL 136 001 R2110	9		
						100...250	100...250	AF09-30-10-13	1SBL 137 001 R1310			
5.5	11.5	MS132-12	1SAM 350 000 R1012	8.00...12.0	180	24...60	20...60	AF12Z-30-10-21	1SBL 156 001 R2110	12		
						100...250	100...250	AF12-30-10-13	1SBL 157 001 R1310			
7.5	15.5	MS132-16	1SAM 350 000 R1011	10.0...16.0	240	24...60	20...60	AF16Z-30-10-21	1SBL 176 001 R2110	16		
						100...250	100...250	AF16-30-10-13	1SBL 177 001 R1310			
11	22	MS132-25	1SAM 350 000 R1014	20.0...25.0	375	24...60	20...60	AF26Z-30-00-21	1SBL 236 001 R2100	25	BEA38-4	1SBN 082 306 T2000
						100...250	100...250	AF26-30-00-13	1SBL 237 001 R1300		+	
15	29	MS132-32	1SAM 350 000 R1015	25.0...32.0	480	24...60	20...60	AF30Z-30-00-21	1SBL 276 001 R2100	32	BER38-4	1SBN 082 311 R1000
						100...250	100...250	AF30-30-00-13	1SBL 277 001 R1300		+	
											VEM4	1SBN 030 111 R1000
											2x CA4-10	1SBN 010 110 R1010

(1) MS116 manual motor starter can be selected according to the current setting range indicated on the coordination line, up to :

- 7.5 kW, 400 V - AC-3 at 16 kA
- 4 kW, 400 V - AC-3 at 50 kA.

(2) For other control voltages, see "3-pole contactors - Ordering details" pages.

Reversing Starters Protected by MS132 Manual Motor Starters

Coordination Type 2

Catalogue Page 1SBC 101 259 S0201



Coordination Type 2, AC-3, 16 kA or 50 kA, 400 V, 50/60 Hz

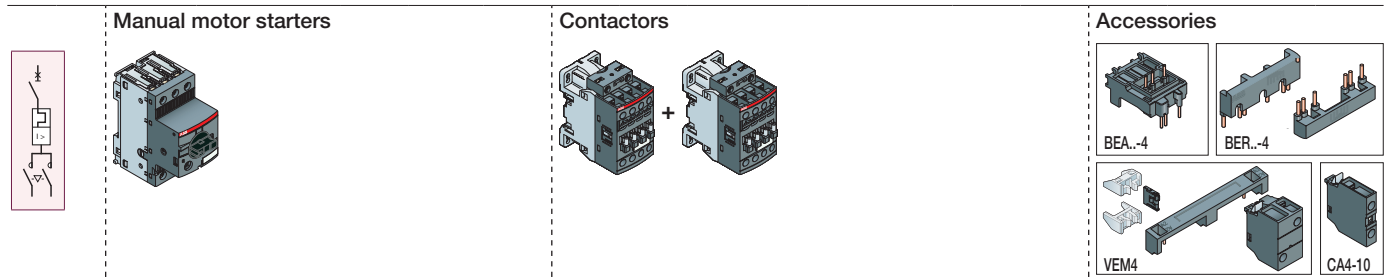

IEC	Type	Order code	Current setting range	Magnetic tripping current	Control voltage U _{min} ... U _{max}	Type	Order code	Allowed setting current	Type	Order code
AC-3, 400 V	(1)		A	A	V 50/60 Hz; V DC	(3)		A	(4)	
Rated power kW	Rated current A									

I_q = 16 kA

I_q = 50 kA

0.06	0.2	MS132-0.25	1SAM 350 000 R1002	0.16...0.25	2.44	24...60	20...60	AF09Z-30-10-21	1SBL 136 001 R2110	0.25	BEA16-4	1SBN 081 306 T1000
						100...250	100...250	AF09-30-10-13	1SBL 137 001 R1310		+	+
0.09	0.3	MS132-0.4	1SAM 350 000 R1003	0.25...0.40	3.9	24...60	20...60	AF09Z-30-10-21	1SBL 136 001 R2110	0.4	BER16-4	1SBN 081 311 R1000
						100...250	100...250	AF09-30-10-13	1SBL 137 001 R1310		+	+
0.12	0.44	MS132-0.63	1SAM 350 000 R1004	0.40...0.63	6.14	24...60	20...60	AF09Z-30-10-21	1SBL 136 001 R2110	0.63	VEM4	1SBN 030 111 R1000
						100...250	100...250	AF09-30-10-13	1SBL 137 001 R1310			
0.18	0.6	MS132-0.63	1SAM 350 000 R1004	0.40...0.63	6.14	24...60	20...60	AF09Z-30-10-21	1SBL 136 001 R2110	0.63		
						100...250	100...250	AF09-30-10-13	1SBL 137 001 R1310			
0.25	0.85	MS132-1.0	1SAM 350 000 R1005	0.63...1.00	11.5	24...60	20...60	AF09Z-30-10-21	1SBL 136 001 R2110	1		
						100...250	100...250	AF09-30-10-13	1SBL 137 001 R1310			
0.37	1.1	MS132-1.6	1SAM 350 000 R1006	1.00...1.60	18.4	24...60	20...60	AF09Z-30-10-21	1SBL 136 001 R2110	1.6		
						100...250	100...250	AF09-30-10-13	1SBL 137 001 R1310			
0.55	1.5	MS132-1.6	1SAM 350 000 R1006	1.00...1.60	18.4	24...60	20...60	AF09Z-30-10-21	1SBL 136 001 R2110	1.6		
						100...250	100...250	AF09-30-10-13	1SBL 137 001 R1310			
0.75	1.9	MS132-2.5	1SAM 350 000 R1007	1.60...2.50	28.75	24...60	20...60	AF09Z-30-10-21	1SBL 136 001 R2110	2.5		
						100...250	100...250	AF09-30-10-13	1SBL 137 001 R1310			
1.1	2.7	MS132-4.0	1SAM 350 000 R1008	2.50...4.00	50	24...60	20...60	AF26Z-30-00-21	1SBL 236 001 R2100	4	BEA26-4	1SBN 082 306 T1000
						100...250	100...250	AF26-30-00-13	1SBL 237 001 R1300		+	+
1.5	3.6	MS132-4.0	1SAM 350 000 R1008	2.50...4.00	50	24...60	20...60	AF26Z-30-00-21	1SBL 236 001 R2100	4	BER38-4	1SBN 082 311 R1000
						100...250	100...250	AF26-30-00-13	1SBL 237 001 R1300		+	+
2.2	4.9	MS132-6.3	1SAM 350 000 R1009	4.00...6.30	78.75	24...60	20...60	AF26Z-30-00-21	1SBL 236 001 R2100	6.3	VEM4	1SBN 030 111 R1000
						100...250	100...250	AF26-30-00-13	1SBL 237 001 R1300		+	+
3	6.5	MS132-10	1SAM 350 000 R1010	6.30...10.0	150	24...60	20...60	AF26Z-30-00-21	1SBL 236 001 R2100	10	2x CA4-10	1SBN 010 110 R1010
						100...250	100...250	AF26-30-00-13	1SBL 237 001 R1300			
4	8.5	MS132-10	1SAM 350 000 R1010	6.30...10.0	150	24...60	20...60	AF26Z-30-00-21	1SBL 236 001 R2100	10		
						100...250	100...250	AF26-30-00-13	1SBL 237 001 R1300			
5.5	11.5	MS132-12	1SAM 350 000 R1012	8.00...12.0	180	24...60	20...60	AF26Z-30-00-21	1SBL 236 001 R2100	12	BEA38-4	1SBN 082 306 T2000
						100...250	100...250	AF26-30-00-13	1SBL 237 001 R1300		+	+
7.5	15.5	MS132-16	1SAM 350 000 R1011	10.0...16.0	240	24...60	20...60	AF30Z-30-00-21	1SBL 276 001 R2100	16	BER38-4	1SBN 082 311 R1000
						100...250	100...250	AF30-30-00-13	1SBL 277 001 R1300		+	+
11	22	MS132-25	1SAM 350 000 R1014	20.0...25.0	375	24...60	20...60	AF30Z-30-00-21	1SBL 276 001 R2100	25	VEM4	1SBN 030 111 R1000
						100...250	100...250	AF30-30-00-13	1SBL 277 001 R1300		+	+
15	29	MS132-32	1SAM 350 000 R1015	25.0...32.0	480	24...60	20...60	AF30Z-30-00-21	1SBL 276 001 R2100	32	2x CA4-10	1SBN 010 110 R1010
						100...250	100...250	AF30-30-00-13	1SBL 277 001 R1300			

(1) MS116 manual motor starter can be selected according to the current setting range indicated on the coordination line, up to:

- 7.5 kW, 400 V - AC-3 at 16 kA
- 4 kW, 400 V - AC-3 at 50 kA.

(2) For other control voltages, see "3-pole contactors - Ordering details" pages.

(3) AF26... 3-pole contactor can be selected for coordination type 2, 16 kA, 7.5 kW, 400 V - AC-3.

(4) BEA38-4 cannot be selected with MS116 manual motor starters

DOL Starters Protected by MS116 Manual Motor Starters With AF Contactors - Open Type Version in Kit Form

Catalogue Page 1SBC 101 125 S0201



Dimensions mm, inches

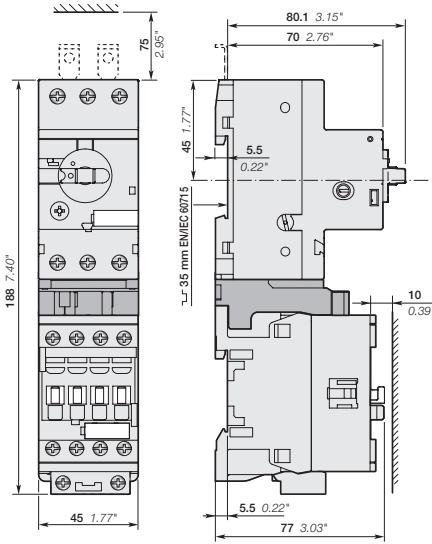

MS116
+ BEA16-4
+ AF09, AF12, AF16

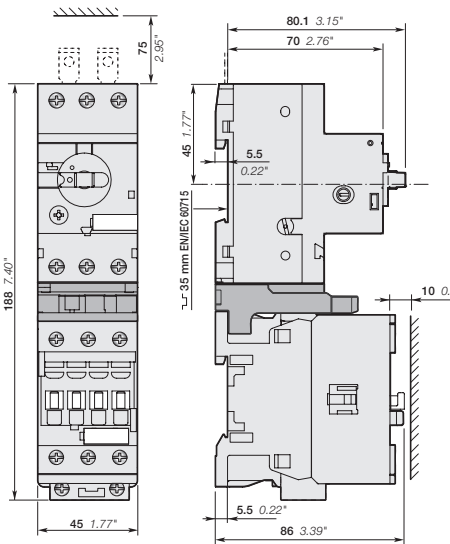

MS116
+ BEA26-4
+ AF26, AF30, AF38

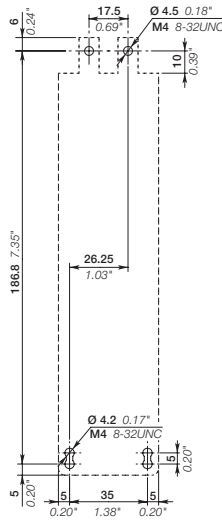

Note: contactor lateral distance to grounded component 2 mm 0.08 inches min.

DOL Starters Protected by MS132 Manual Motor Starters With AF Contactors - Open Type Version in Kit Form

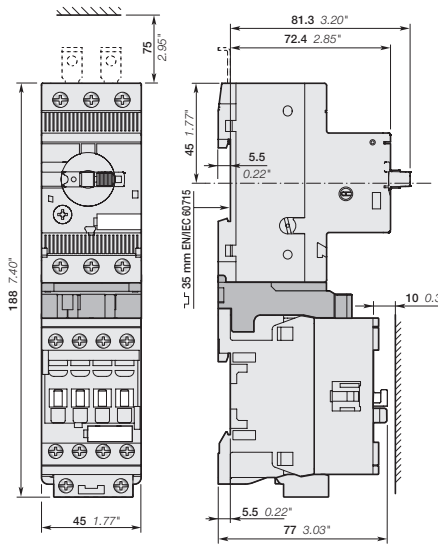

MS132-0.16 ... MS132-10
+ BEA16-4
+ AF09, AF12, AF16

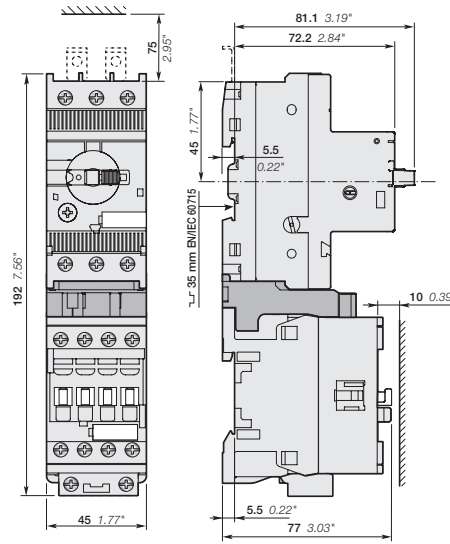

MS132-12 ... MS132-25
+ BEA16-4
+ AF09, AF12, AF16

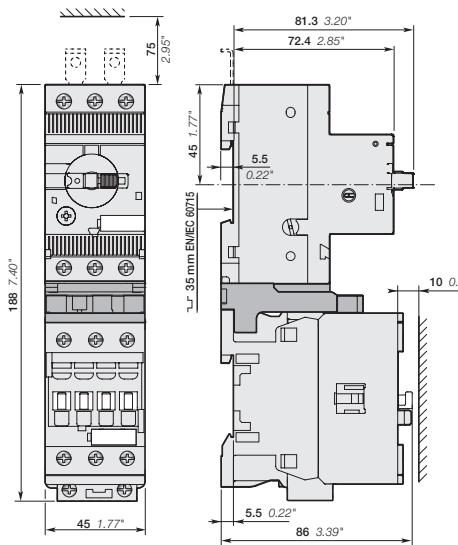

MS132-0.16 ... MS132-10
+ BEA26-4
+ AF26, AF30, AF38

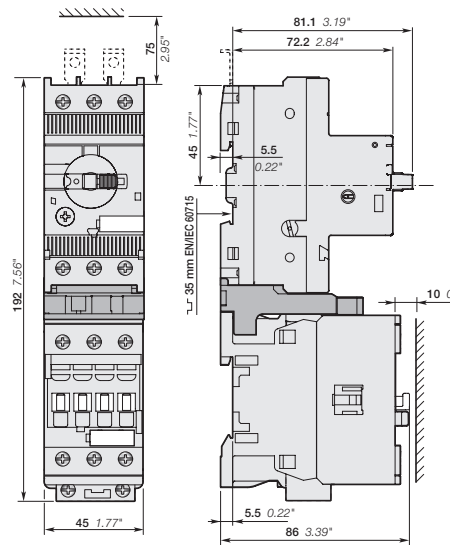

MS132-12 ... MS132-32
+ BEA38-4
+ AF26, AF30, AF38

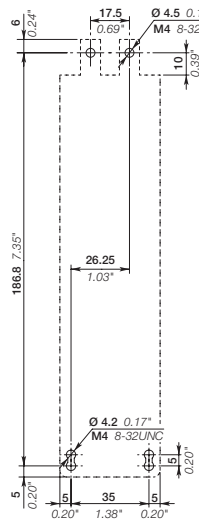

Note: contactor lateral distance to grounded component 2 mm 0.08" min.

Reversing Starters Protected by MS116 Manual Motor Starters With AF Contactors - Open Type Version in Kit Form



Dimensions mm, inches

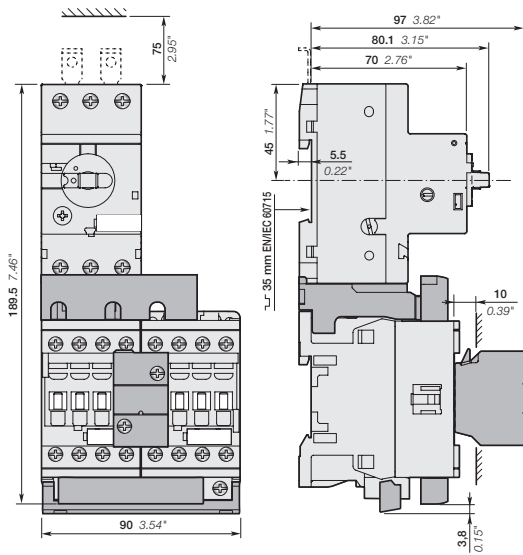

MS116
+ BEA16-4, BER16-4, VEM4
+ AF09, AF12, AF16

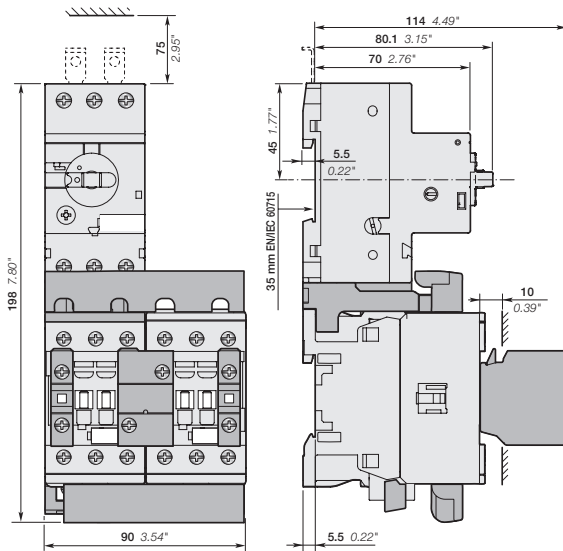

MS116
+ BEA26-4, BER38-4, VEM4, CA4-10
+ AF26, AF30, AF38

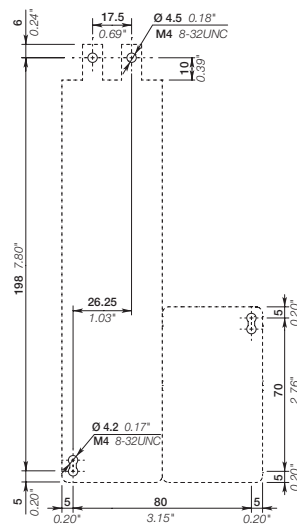

Note: contactor lateral distance to grounded component 2 mm 0.08" min.

Reversing Starters Protected by MS132 Manual Motor Starters With AF Contactors - Open Type Version in Kit Form



Dimensions mm, inches

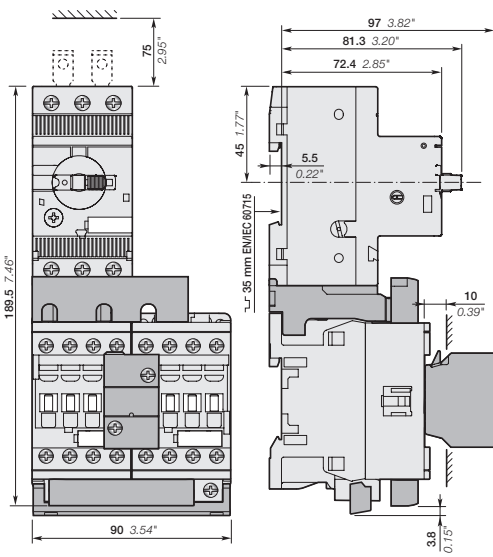

MS132-0.16 ... MS132-10
+ BEA16-4, BER16-4, VEM4
+ AF09, AF12, AF16

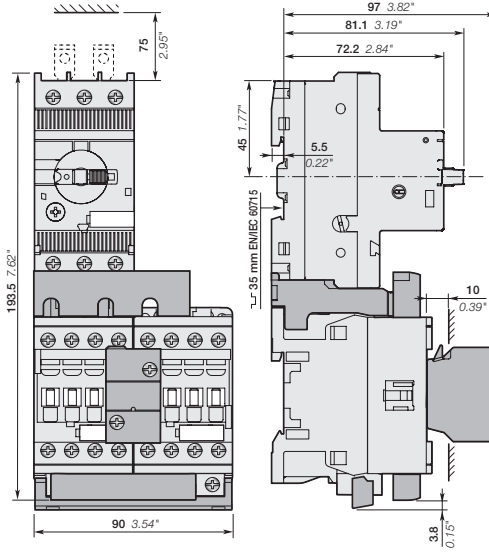

MS132-12 ... MS132-25
+ BEA16-4, BER16-4, VEM4
+ AF09, AF12, AF16

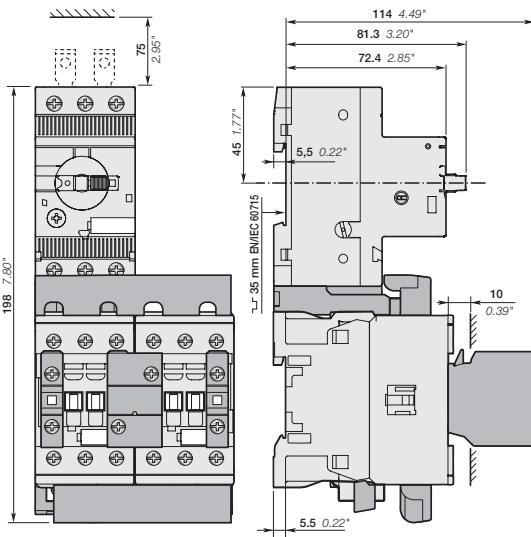

MS132-0.16 ... MS132-10
+ BEA26-4, BER38-4, VEM4, CA4-10
+ AF26, AF30, AF38

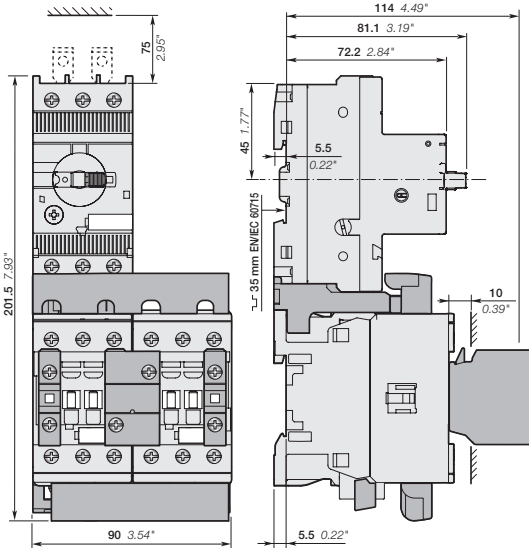

MS132-12 ... MS132-32
+ BEA38-4, BER38-4, VEM4, CA4-10
+ AF26, AF30, AF38

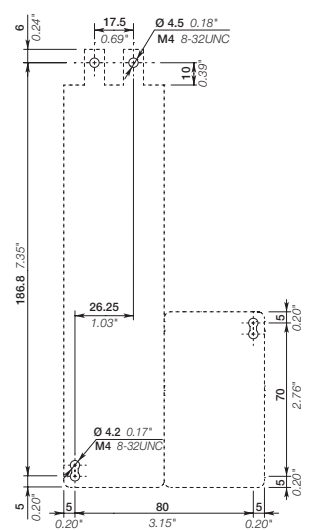

Note: contactor lateral distance to grounded component 2 mm 0.08" min.

DOL & Reversing Starters Protected by Thermal Overload Relay With AF Contactors - Open Type Version in Kit Form



AF16-30-10 + TF42

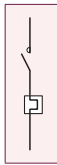

Application

Full voltage direct-on-line and reversing starting for controlling three-phase asynchronous motors is a simple and economic solution characterised by a high starting torque (1.9 to 2.1 times full-speed torque) and a starting current 5.5 to 7 times nominal current.

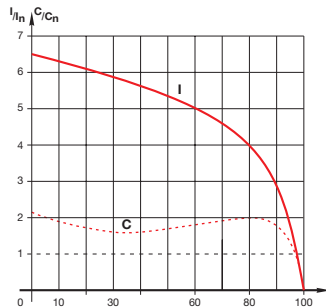

I = current
C = torque
 I_n = nominal current
 C_n = nominal torque

Coordination Types

The contactor, the short-circuit protection device and the thermal overload relay control and protect motors against overload and short-circuits according to coordination types 1 and 2 (IEC 60947-4-1 / EN 60947-4-1) defining the anticipated level of service continuity as follow:

Type 1: In short-circuit conditions, the contactor or starter does not endanger persons or installations and will not be able to then operate without being repaired or having parts replaced.

Type 2: In short-circuit conditions, the contactor or starter does not endanger persons or installations and will be able to operate afterwards. The risk of contacts light welding is acceptable.

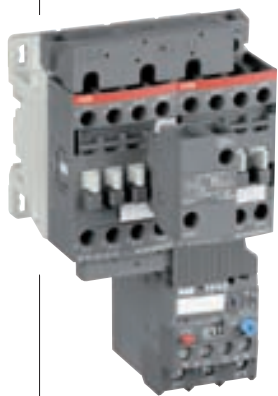

AF16-30-10 + BER16-4 + VEM4 + TF42



Main Technical Data

Standards	IEC 60947-4-1 / EN 60947-4-1
Rated operational voltage U_o max.	690 V - 50/60 Hz
Rated insulation voltage U_i according to IEC 60947-4-1	690 V
Air temperature close to the device	≤ 60 °C (above 38 A ≤ 50 °C)
Degree of protection	IP 20

Switching Frequency

Thermal overload relays cannot be operated at any arbitrary switching frequency in order to avoid tripping. Applications involving up to 15 operations per hour are acceptable. Higher switching frequencies are permitted if the duty ratio and the motor's making current does not appreciably exceed 6 times the rated operating current. Please refer to the adjacent diagram for guideline values for the permitted switching frequency.

Example:

Starting time of the motor: 1 second Duty ratio: 40 % means a permitted switching frequency of max. 60 operating cycles per hour.

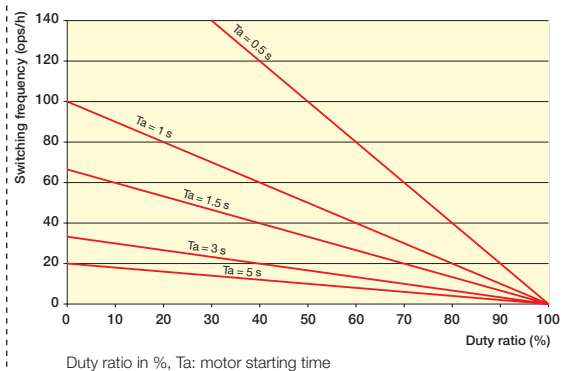

Mounting positions

Direct-on-line

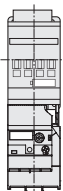

Pos. 1

Reversing

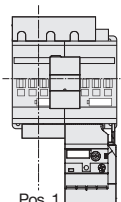

Pos. 1

DOL & Reversing Starters Protected by Thermal Overload Relay With AF Contactors - Open Type Version in Kit Form

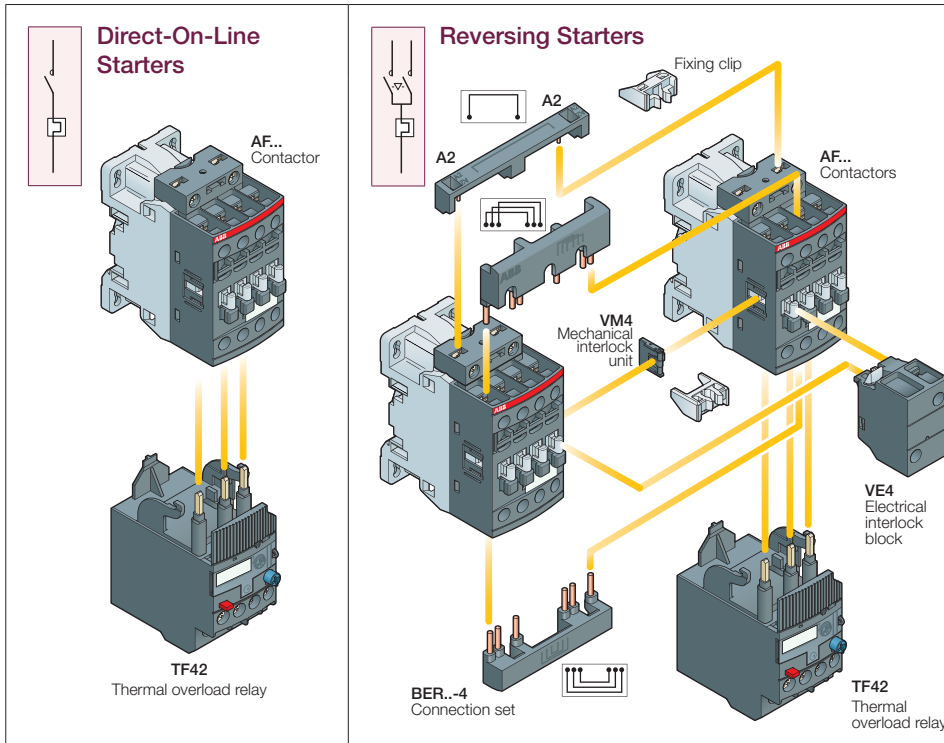

Description

You can easily assemble a direct-on-line starter by connecting AF contactor and TF42 thermal overload relay.

You can easily assemble reversing starter thanks to our complete range of accessories:

- VEM4 mechanical and electrical interlock set for reversing starter in 90 mm width.

It includes:

- VM4 mechanical interlock unit including 2 fixing clips
- VE4 electrical interlock block with A2-A2 connection.
- BER..-4 connection set: it assures a safe and simple reversing connection between both contactor main terminals.

Select now easily and quickly your starter in the following pages at 400 V, up to 18.5 kW.

For complete coordination tables, please contact your ABB local sales organization.

Wiring Diagrams

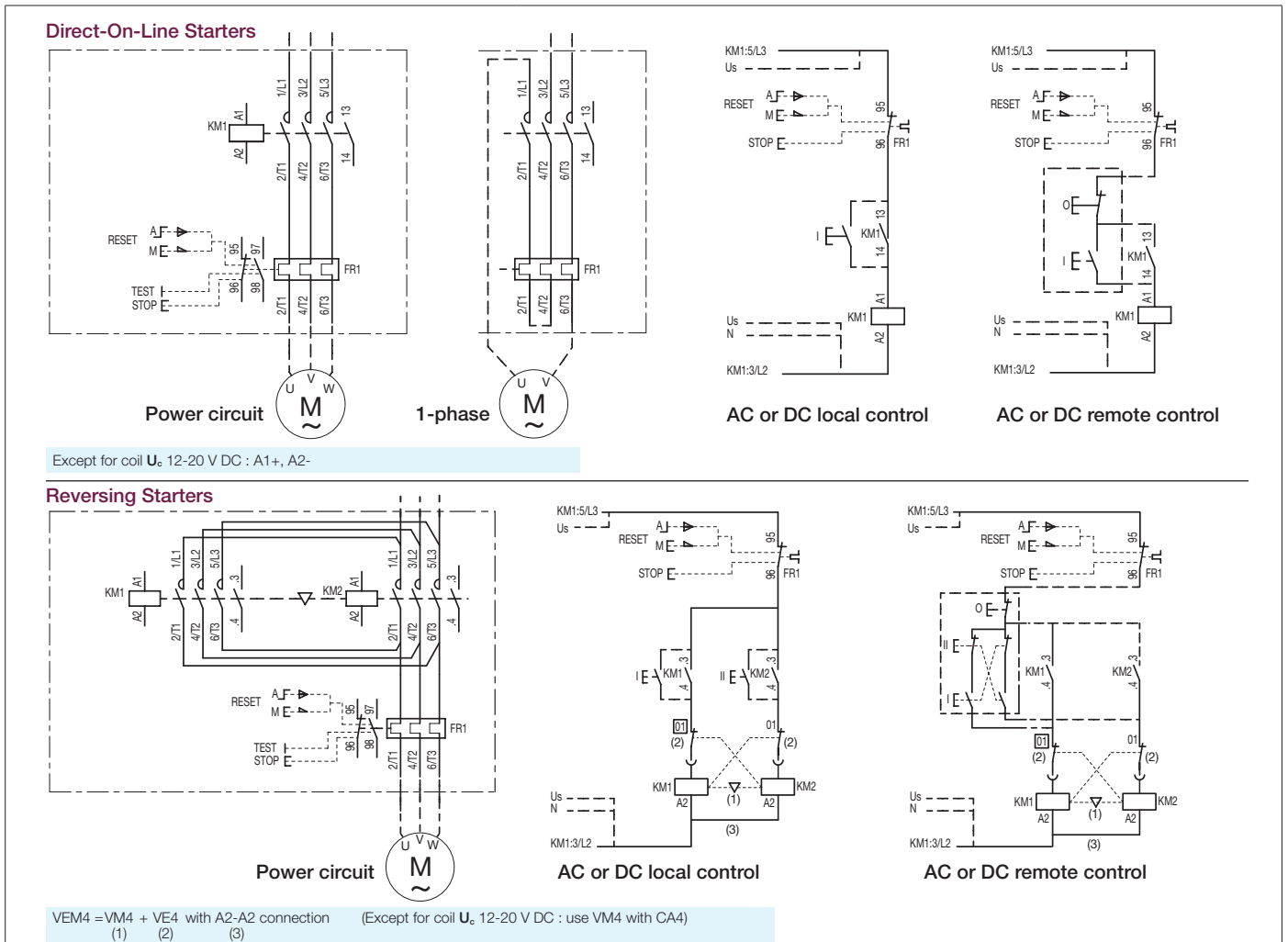

Direct-On-Line Starters Protected by Thermal Overload Relay With AF Contactors - Open Type Version in Kit Form

Catalogue Page 1SBC 101 262 S0201



Contactors				Thermal overload relays			Accessories	
IEC	Control voltage U_c min. ... U_c max. (1)		Type	Order code	Setting ranges	Type	Order code	
Rated power kW	Rated current A	V 50/60 Hz	V DC		A ... A			
4	8.5	24...60	20...60	AF09Z-30-10-21	1SBL 136 001 R2110	7.60 ... 10.0	TF42-10	1SAZ 721 201 R1043
		48...130	48...130	AF09-30-10-12	1SBL 137 001 R1210			
		100...250	100...250	AF09-30-10-13	1SBL 137 001 R1310			
		250...500	250...500	AF09-30-10-14	1SBL 137 001 R1410			
5.5	11.5	24...60	20...60	AF12Z-30-10-21	1SBL 156 001 R2110	10.0 ... 13.0	TF42-13	1SAZ 721 201 R1045
		48...130	48...130	AF12-30-10-12	1SBL 157 001 R1210			
		100...250	100...250	AF12-30-10-13	1SBL 157 001 R1310			
		250...500	250...500	AF12-30-10-14	1SBL 157 001 R1410			
7.5	15.5	24...60	20...60	AF16Z-30-10-21	1SBL 176 001 R2110	13.0 ... 16.0	TF42-16	1SAZ 721 201 R1047
		48...130	48...130	AF16-30-10-12	1SBL 177 001 R1210			
		100...250	100...250	AF16-30-10-13	1SBL 177 001 R1310			
		250...500	250...500	AF16-30-10-14	1SBL 177 001 R1410			
11	22	24...60	20...60	AF26Z-30-00-21	1SBL 236 001 R2100	20.0 ... 24.0	TF42-24	1SAZ 721 201 R1051
		48...130	48...130	AF26-30-00-12	1SBL 237 001 R1200			
		100...250	100...250	AF26-30-00-13	1SBL 237 001 R1300			
		250...500	250...500	AF26-30-00-14	1SBL 237 001 R1400			
15	29	24...60	20...60	AF30Z-30-00-21	1SBL 276 001 R2100	29.0 ... 35.0	TF42-35	1SAZ 721 201 R1053
		48...130	48...130	AF30-30-00-12	1SBL 277 001 R1200			
		100...250	100...250	AF30-30-00-13	1SBL 277 001 R1300			
		250...500	250...500	AF30-30-00-14	1SBL 277 001 R1400			
18.5	35	24...60	20...60	AF38Z-30-00-21	1SBL 296 001 R2100	35.0 ... 38.0/40.0	TF42-38	1SAZ 721 201 R1055
		48...130	48...130	AF38-30-00-12	1SBL 297 001 R1200			
		100...250	100...250	AF38-30-00-13	1SBL 297 001 R1300			
		250...500	250...500	AF38-30-00-14	1SBL 297 001 R1400			

(1) For other control voltages, see "3-pole contactors - Ordering details" pages.

see table below for all setting ranges

Setting ranges	Type	Order code
A ... A		
0.10 ... 0.13	TF42-0.13	1SAZ 721 201 R1005
0.13 ... 0.17	TF42-0.17	1SAZ 721 201 R1008
0.17 ... 0.23	TF42-0.23	1SAZ 721 201 R1009
0.23 ... 0.31	TF42-0.31	1SAZ 721 201 R1013
0.31 ... 0.41	TF42-0.41	1SAZ 721 201 R1014
0.41 ... 0.55	TF42-0.55	1SAZ 721 201 R1017
0.55 ... 0.74	TF42-0.74	1SAZ 721 201 R1021
0.74 ... 1.00	TF42-1.0	1SAZ 721 201 R1023
1.00 ... 1.30	TF42-1.3	1SAZ 721 201 R1025
1.30 ... 1.70	TF42-1.7	1SAZ 721 201 R1028
1.70 ... 2.30	TF42-2.3	1SAZ 721 201 R1031
2.30 ... 3.10	TF42-3.1	1SAZ 721 201 R1033
3.10 ... 4.20	TF42-4.2	1SAZ 721 201 R1035
4.20 ... 5.70	TF42-5.7	1SAZ 721 201 R1038
5.70 ... 7.60	TF42-7.6	1SAZ 721 201 R1040
7.60 ... 10.0	TF42-10	1SAZ 721 201 R1043
10.0 ... 13.0	TF42-13	1SAZ 721 201 R1045
13.0 ... 16.0	TF42-16	1SAZ 721 201 R1047
16.0 ... 20.0	TF42-20	1SAZ 721 201 R1049
20.0 ... 24.0	TF42-24	1SAZ 721 201 R1051
24.0 ... 29.0	TF42-29	1SAZ 721 201 R1052
29.0 ... 35.0	TF42-35	1SAZ 721 201 R1053
35.0 ... 38.0/40.0	TF42-38	1SAZ 721 201 R1055

Reversing Starters Protected by Thermal Overload Relay With AF Contactors - Open Type Version in Kit Form



Contactors				Thermal overload relays				Accessories			
IEC		Control voltage U_c min. ... U_c max. (1)		Type	Order code	Setting ranges	Type	Order code	Type	Order code	
Rated power kW	Rated current A	V 50/60 Hz				A ... A					
		V	VDC								
4	8.5	24...60	20...60	AF09Z-30-10-21	1SBL 136 001 R2110	7.60 ... 10.0	TF42-10	1SAZ 721 201 R1043	BER16-4 + VEM4	1SBN 081 311 R1000 + 1SBN 030 111 R1000	
		48...130	48...130	AF09-30-10-12	1SBL 137 001 R1210						
		100...250	100...250	AF09-30-10-13	1SBL 137 001 R1310						
		250...500	250...500	AF09-30-10-14	1SBL 137 001 R1410						
5.5	11.5	24...60	20...60	AF12Z-30-10-21	1SBL 156 001 R2110	10.0 ... 13.0	TF42-13	1SAZ 721 201 R1045	BER16-4 + VEM4	1SBN 081 311 R1000 + 1SBN 030 111 R1000	
		48...130	48...130	AF12-30-10-12	1SBL 157 001 R1210						
		100...250	100...250	AF12-30-10-13	1SBL 157 001 R1310						
		250...500	250...500	AF12-30-10-14	1SBL 157 001 R1410						
7.5	15.5	24...60	20...60	AF16Z-30-10-21	1SBL 176 001 R2110	13.0 ... 16.0	TF42-16	1SAZ 721 201 R1047	BER16-4 + VEM4	1SBN 081 311 R1000 + 1SBN 030 111 R1000	
		48...130	48...130	AF16-30-10-12	1SBL 177 001 R1210						
		100...250	100...250	AF16-30-10-13	1SBL 177 001 R1310						
		250...500	250...500	AF16-30-10-14	1SBL 177 001 R1410						
11	22	24...60	20...60	AF26Z-30-00-21	1SBL 236 001 R2100	20.0 ... 24.0	TF42-24	1SAZ 721 201 R1051	BER38-4 + VEM4 + 2x CA4-10	1SBN 082 311 R1000 + 1SBN 030 111 R1000 + 1SBN 010 110 R1010	
		48...130	48...130	AF26-30-00-12	1SBL 237 001 R1200						
		100...250	100...250	AF26-30-00-13	1SBL 237 001 R1300						
		250...500	250...500	AF26-30-00-14	1SBL 237 001 R1400						
15	29	24...60	20...60	AF30Z-30-00-21	1SBL 276 001 R2100	29.0 ... 35.0	TF42-35	1SAZ 721 201 R1053	BER38-4 + VEM4 + 2x CA4-10	1SBN 082 311 R1000 + 1SBN 030 111 R1000 + 1SBN 010 110 R1010	
		48...130	48...130	AF30-30-00-12	1SBL 277 001 R1200						
		100...250	100...250	AF30-30-00-13	1SBL 277 001 R1300						
		250...500	250...500	AF30-30-00-14	1SBL 277 001 R1400						
18.5	35	24...60	20...60	AF38Z-30-00-21	1SBL 296 001 R2100	35.0 ... 38.0/40.0	TF42-38	1SAZ 721 201 R1055	BER38-4 + VEM4 + 2x CA4-10	1SBN 082 311 R1000 + 1SBN 030 111 R1000 + 1SBN 010 110 R1010	
		48...130	48...130	AF38-30-00-12	1SBL 297 001 R1200						
		100...250	100...250	AF38-30-00-13	1SBL 297 001 R1300						
		250...500	250...500	AF38-30-00-14	1SBL 297 001 R1400						

(1) For other control voltages, see "3-pole contactors - Ordering details" pages.

see table below for all setting ranges

Setting ranges	Type	Order code
A ... A		
0.10 ... 0.13	TF42-0.13	1SAZ 721 201 R1005
0.13 ... 0.17	TF42-0.17	1SAZ 721 201 R1008
0.17 ... 0.23	TF42-0.23	1SAZ 721 201 R1009
0.23 ... 0.31	TF42-0.31	1SAZ 721 201 R1013
0.31 ... 0.41	TF42-0.41	1SAZ 721 201 R1014
0.41 ... 0.55	TF42-0.55	1SAZ 721 201 R1017
0.55 ... 0.74	TF42-0.74	1SAZ 721 201 R1021
0.74 ... 1.00	TF42-1.0	1SAZ 721 201 R1023
1.00 ... 1.30	TF42-1.3	1SAZ 721 201 R1025
1.30 ... 1.70	TF42-1.7	1SAZ 721 201 R1028
1.70 ... 2.30	TF42-2.3	1SAZ 721 201 R1031
2.30 ... 3.10	TF42-3.1	1SAZ 721 201 R1033
3.10 ... 4.20	TF42-4.2	1SAZ 721 201 R1035
4.20 ... 5.70	TF42-5.7	1SAZ 721 201 R1038
5.70 ... 7.60	TF42-7.6	1SAZ 721 201 R1040
7.60 ... 10.0	TF42-10	1SAZ 721 201 R1043
10.0 ... 13.0	TF42-13	1SAZ 721 201 R1045
13.0 ... 16.0	TF42-16	1SAZ 721 201 R1047
16.0 ... 20.0	TF42-20	1SAZ 721 201 R1049
20.0 ... 24.0	TF42-24	1SAZ 721 201 R1051
24.0 ... 29.0	TF42-29	1SAZ 721 201 R1052
29.0 ... 35.0	TF42-35	1SAZ 721 201 R1053
35.0 ... 38.0/40.0	TF42-38	1SAZ 721 201 R1055

Star-delta Starters Protected by Thermal Overload Relay With AF Contactors - Open Type Version in Kit Form

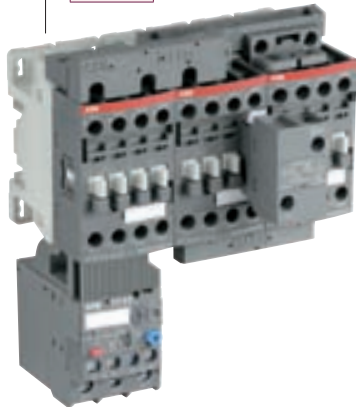
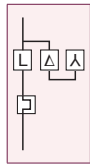

AF16-30-10 + AF16-30-10 + AF09-30-10
+ BEY16-4 + VEM4 + TF42

Application

Star-delta starting is the most common method to reduce the starting current of a motor. This system can be used on all the squirrel cage motors, which are normally used in delta connection. In this type of starting, it is recommended to choose motors having high starting torque i.e. much higher than the resistive torque in order to reach sufficient high speed when the motor is connected in star.

When Starting:

- Inrush current is reduced to a third of direct starting current
- Motor torque is reduced to a third or even less of direct starting torque.

Transient current is generated when switching from star to delta connection.

During the initial starting phase ("star" connection), the resistive torque of the driven load must remain, irrespective of speed, less than the "star" motor torque until "star-delta" switching occurs.

This starting mode is therefore ideal for machines having low starting torque such as pumps, centrifugal compressors, wood-working machines...

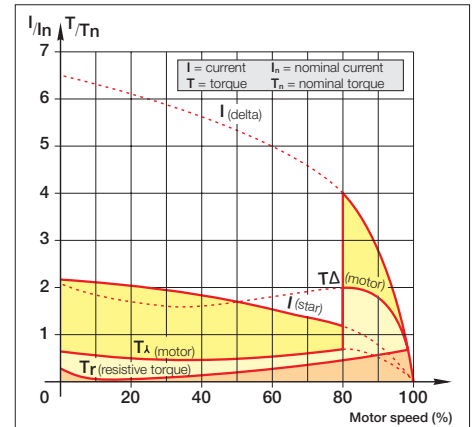

Precaution

- Motor nominal voltage in delta connection must be equal to that of the mains. Example: a motor for 400 V star-delta starting must be designed for 400 V in "delta" connection. Its usual designation is "400 V / 690 V motor". The motor must be constructed with 6 terminal windings
- In order to prevent a high current peak, at least 85 % of nominal speed must be reached before switching from star to delta

Sequence

Starting is a three-stage process:

- 1st stage:** "Star" connection - Press the "On" button on the control circuit to close the KM2 "Star" contactor. The KM1 "line" contactor then closes and the motor starts. Countdown of programmed starting time (6 to 10 s) then begins.
- 2nd stage:** "Star" to "Delta" switching - when programmed starting time is over, the KM2 "Star" contactor opens.
- 3rd stage:** "Delta" connection - Thanks to AF contactors, a transition time (or dwelling time) of 50 ms is already integrated between the opening of the "star" contactor and closing of the "delta" contactor.

Conclusion: An on-delay timer without dwelling time (e.g.: CT-ERS.21) is enough to countdown the programmed starting time (6 to 10 s) during "Star connection". The use of a star-delta timer including a dwelling time is not permitted.

Main Technical Data

Standards	IEC 60947-4-1 / EN 60947-4-1
Rated operational voltage U_n max.	690 V - 50/60 Hz
Rated insulation voltage U_i according to IEC 60947-4-1	690 V
Air temperature close to the device	$\leq 60^\circ\text{C}$ (above 38 A $\leq 50^\circ\text{C}$)
Degree of protection	IP 20

Switching frequency

Switching frequency/hour, according to acceleration time and load factor). Respect of the following conditions enables utilization of the starter without excessive overheating of the connections or nuisance tripping of the thermal overload relay.

Example:

- Switching frequency = 15 starts/hr
- Motor starting time "Ta" = 7 s (use 8 s curve)
- Maximum load factor = 63 %.

This corresponds to a 4-minute operating cycle (15 starts/hr) with 7 seconds acceleration, 2.5 minutes operation and 1.5 minutes rest.

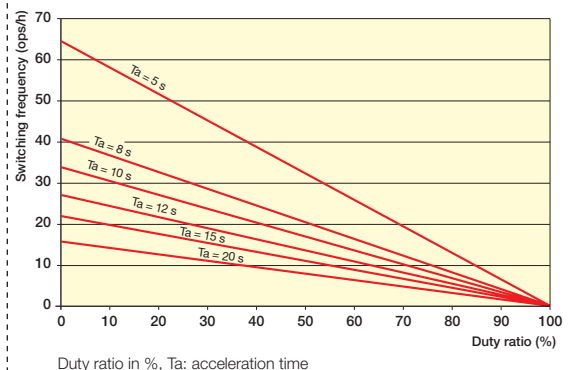

Mounting positions

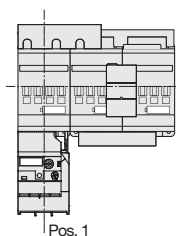

Star-delta Starters Protected by Thermal Overload Relay With AF Contactors - Open Type Version in Kit Form

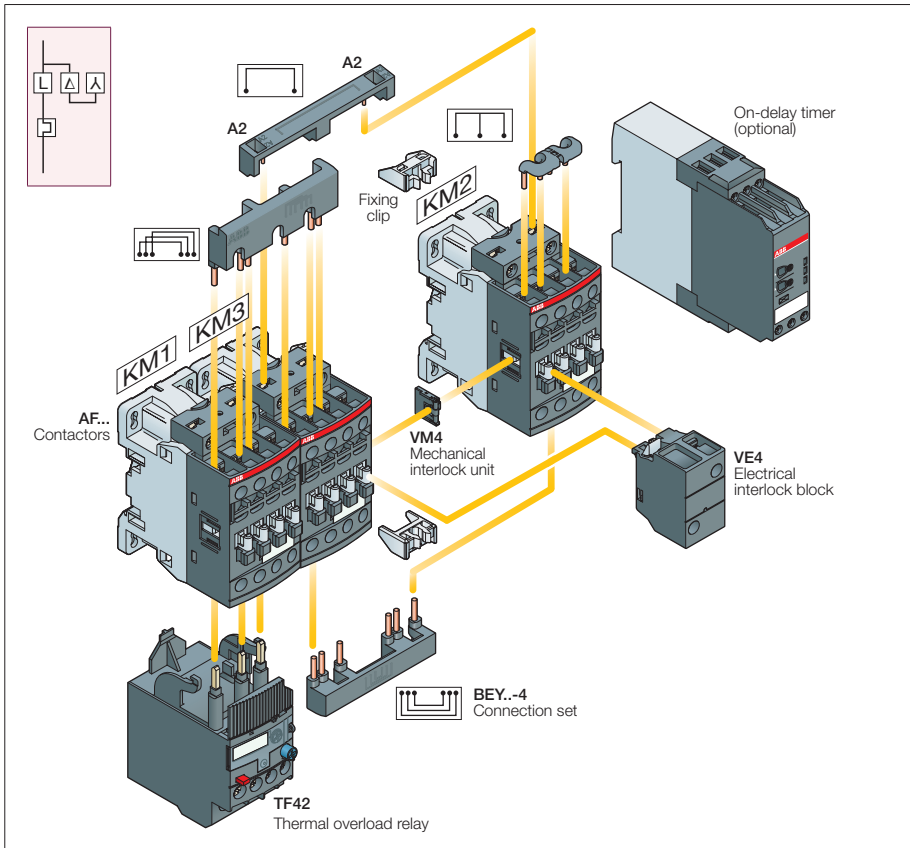

Description

You can easily assemble a star-delta starter thanks to our complete range of accessories:

- VEM4 mechanical and electrical interlock set without increasing starter width.

It includes:

- VM4 mechanical interlock unit and fixing clips
- VE4 electrical interlock block with A2-A2 connection.
- BEY...-4 connection set: it assures a safe and simple connection between contactors main terminals.

Select now easily and quickly your starter in the following pages at 400 V, up to 25 kW.

For complete coordination tables, please contact your ABB local sales organization.

Wiring Diagrams

Star-delta starter

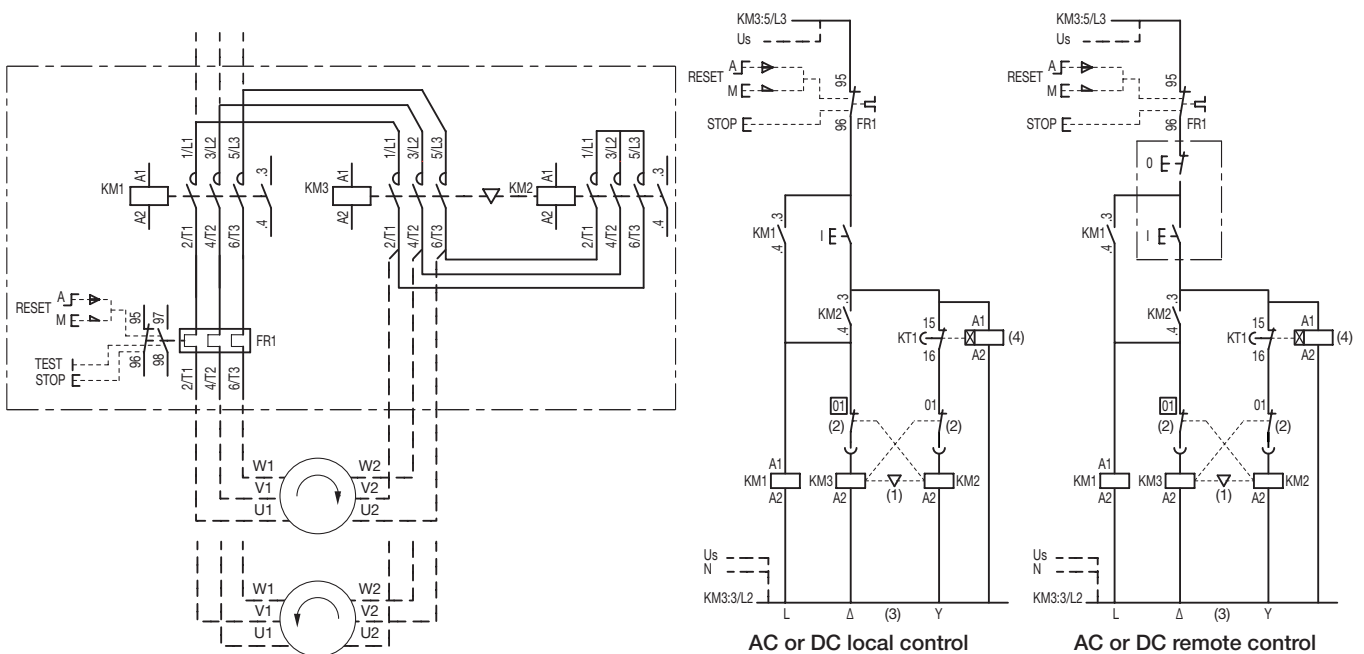

VEM4 = VM4 + VE4 with A2-A2 connection (1) (2) (3) (Except for coil U_c : 12-20 V DC : use VM4 with CA4)

(4) On-delay timer without dwelling time e.g. CT-ERS.21

Star-delta Starters Protected by Thermal Overload Relay With AF Contactors - Open Type Version in Kit Form

Catalogue Page 1SBC 101 264 S0201

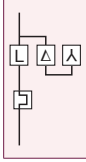

Line contactor KM1

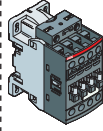

Delta contactor KM3

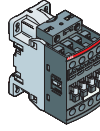

Star contactor KM2

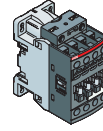

IEC		Control voltage		Type	Order code	Type	Order code	Type	Order code
AC-3, 400 V		U _c min. ... U _c max.							
Rated power	Rated current	(1)							
	kW	A	V 50/60 Hz	V DC					
7.5	15.5	24...60	20...60	AF09Z-30-10-21	1SBL 136 001 R2110	AF09Z-30-10-21	1SBL 136 001 R2110	AF09Z-30-10-21	1SBL 136 001 R2110
		48...130	48...130	AF09-30-10-12	1SBL 137 001 R1210	AF09-30-10-12	1SBL 137 001 R1210	AF09-30-10-12	1SBL 137 001 R1210
		100...250	100...250	AF09-30-10-13	1SBL 137 001 R1310	AF09-30-10-13	1SBL 137 001 R1310	AF09-30-10-13	1SBL 137 001 R1310
		250...500	250...500	AF09-30-10-14	1SBL 137 001 R1410	AF09-30-10-14	1SBL 137 001 R1410	AF09-30-10-14	1SBL 137 001 R1410
11	22	24...60	20...60	AF12Z-30-10-21	1SBL 156 001 R2110	AF12Z-30-10-21	1SBL 156 001 R2110	AF09Z-30-10-21	1SBL 136 001 R2110
		48...130	48...130	AF12-30-10-12	1SBL 157 001 R1210	AF12-30-10-12	1SBL 157 001 R1210	AF09-30-10-12	1SBL 137 001 R1210
		100...250	100...250	AF12-30-10-13	1SBL 157 001 R1310	AF12-30-10-13	1SBL 157 001 R1310	AF09-30-10-13	1SBL 137 001 R1310
		250...500	250...500	AF12-30-10-14	1SBL 157 001 R1410	AF12-30-10-14	1SBL 157 001 R1410	AF09-30-10-14	1SBL 137 001 R1410
15	29	24...60	20...60	AF16Z-30-10-21	1SBL 176 001 R2110	AF16Z-30-10-21	1SBL 176 001 R2110	AF09Z-30-10-21	1SBL 136 001 R2110
		48...130	48...130	AF16-30-10-12	1SBL 177 001 R1210	AF16-30-10-12	1SBL 177 001 R1210	AF09-30-10-12	1SBL 137 001 R1210
		100...250	100...250	AF16-30-10-13	1SBL 177 001 R1310	AF16-30-10-13	1SBL 177 001 R1310	AF09-30-10-13	1SBL 137 001 R1310
		250...500	250...500	AF16-30-10-14	1SBL 177 001 R1410	AF16-30-10-14	1SBL 177 001 R1410	AF09-30-10-14	1SBL 137 001 R1410
18.5	35	24...60	20...60	AF26Z-30-00-21	1SBL 236 001 R2100	AF26Z-30-00-21	1SBL 236 001 R2100	AF26Z-30-00-21	1SBL 236 001 R2100
		48...130	48...130	AF26-30-00-12	1SBL 237 001 R1200	AF26-30-00-12	1SBL 237 001 R1200	AF26-30-00-12	1SBL 237 001 R1200
		100...250	100...250	AF26-30-00-13	1SBL 237 001 R1300	AF26-30-00-13	1SBL 237 001 R1300	AF26-30-00-13	1SBL 237 001 R1300
		250...500	250...500	AF26-30-00-14	1SBL 237 001 R1400	AF26-30-00-14	1SBL 237 001 R1400	AF26-30-00-14	1SBL 237 001 R1400
22	41	24...60	20...60	AF26Z-30-00-21	1SBL 236 001 R2100	AF26Z-30-00-21	1SBL 236 001 R2100	AF26Z-30-00-21	1SBL 236 001 R2100
		48...130	48...130	AF26-30-00-12	1SBL 237 001 R1200	AF26-30-00-12	1SBL 237 001 R1200	AF26-30-00-12	1SBL 237 001 R1200
		100...250	100...250	AF26-30-00-13	1SBL 237 001 R1300	AF26-30-00-13	1SBL 237 001 R1300	AF26-30-00-13	1SBL 237 001 R1300
		250...500	250...500	AF26-30-00-14	1SBL 237 001 R1400	AF26-30-00-14	1SBL 237 001 R1400	AF26-30-00-14	1SBL 237 001 R1400
25	47	24...60	20...60	AF30Z-30-00-21	1SBL 276 001 R2100	AF30Z-30-00-21	1SBL 276 001 R2100	AF26Z-30-00-21	1SBL 236 001 R2100
		48...130	48...130	AF30-30-00-12	1SBL 277 001 R1200	AF30-30-00-12	1SBL 277 001 R1200	AF26-30-00-12	1SBL 237 001 R1200
		100...250	100...250	AF30-30-00-13	1SBL 277 001 R1300	AF30-30-00-13	1SBL 277 001 R1300	AF26-30-00-13	1SBL 237 001 R1300
		250...500	250...500	AF30-30-00-14	1SBL 277 001 R1400	AF30-30-00-14	1SBL 277 001 R1400	AF26-30-00-14	1SBL 237 001 R1400

(1) For other control voltages, see "3-pole contactors - Ordering details" pages.

Note: an on-delay timer without dwelling-time (e.g.: CT-ERS.21 1SVR 630 100 R0300) is enough to countdown the programmed starting time during "Star connection".

Star-delta Starters Protected by Thermal Overload Relay With AF Contactors - Open Type Version in Kit Form



Setting ranges	Thermal overload relays		Connection sets		Mechanical and electrical interlock set		Auxiliary contact block	
	Type	Order code	Type	Order code	Type	Order code	Type	Order code
A ... A								
7.60 ... 10.0	TF42-10	1SAZ 721 201 R1043	BEY16-4	1SBN 081 313 R2000	VEM4	1SBN 030 111 R1000		
10.0 ... 13.0	TF42-13	1SAZ 721 201 R1045	BEY16-4	1SBN 081 313 R2000	VEM4	1SBN 030 111 R1000		
16.0 ... 20.0	TF42-20	1SAZ 721 201 R1049	BEY16-4	1SBN 081 313 R2000	VEM4	1SBN 030 111 R1000		
20.0 ... 24.0	TF42-24	1SAZ 721 201 R1051	BEY38-4	1SBN 082 713 R2000	VEM4	1SBN 030 111 R1000	KM1: 1 x CA4-10 KM2: 1 x CA4-10	1SBN 010 110 R1010 1SBN 010 110 R1010
20.0 ... 24.0	TF42-24	1SAZ 721 201 R1051	BEY38-4	1SBN 082 713 R2000	VEM4	1SBN 030 111 R1000	KM1: 1 x CA4-10 KM2: 1 x CA4-10	1SBN 010 110 R1010 1SBN 010 110 R1010
24.0 ... 29.0	TF42-29	1SAZ 721 201 R1052	BEY38-4	1SBN 082 713 R2000	VEM4	1SBN 030 111 R1000	KM1: 1 x CA4-10 KM2: 1 x CA4-10	1SBN 010 110 R1010 1SBN 010 110 R1010

see table below for all setting ranges

Setting ranges	Type	Order code
A ... A		
0.10 ... 0.13	TF42-0.13	1SAZ 721 201 R1005
0.13 ... 0.17	TF42-0.17	1SAZ 721 201 R1008
0.17 ... 0.23	TF42-0.23	1SAZ 721 201 R1009
0.23 ... 0.31	TF42-0.31	1SAZ 721 201 R1013
0.31 ... 0.41	TF42-0.41	1SAZ 721 201 R1014
0.41 ... 0.55	TF42-0.55	1SAZ 721 201 R1017
0.55 ... 0.74	TF42-0.74	1SAZ 721 201 R1021
0.74 ... 1.00	TF42-1.0	1SAZ 721 201 R1023
1.00 ... 1.30	TF42-1.3	1SAZ 721 201 R1025
1.30 ... 1.70	TF42-1.7	1SAZ 721 201 R1028
1.70 ... 2.30	TF42-2.3	1SAZ 721 201 R1031
2.30 ... 3.10	TF42-3.1	1SAZ 721 201 R1033
3.10 ... 4.20	TF42-4.2	1SAZ 721 201 R1035
4.20 ... 5.70	TF42-5.7	1SAZ 721 201 R1038
5.70 ... 7.60	TF42-7.6	1SAZ 721 201 R1040
7.60 ... 10.0	TF42-10	1SAZ 721 201 R1043
10.0 ... 13.0	TF42-13	1SAZ 721 201 R1045
13.0 ... 16.0	TF42-16	1SAZ 721 201 R1047
16.0 ... 20.0	TF42-20	1SAZ 721 201 R1049
20.0 ... 24.0	TF42-24	1SAZ 721 201 R1051
24.0 ... 29.0	TF42-29	1SAZ 721 201 R1052
29.0 ... 35.0	TF42-35	1SAZ 721 201 R1053
35.0 ... 38.0/40.0	TF42-38	1SAZ 721 201 R1055

DOL & Reversing Starters Protected by Thermal Overload Relay With AF Contactors - Open Type Version in Kit Form



Dimensions (mm, inches)

Direct-on-line Starters

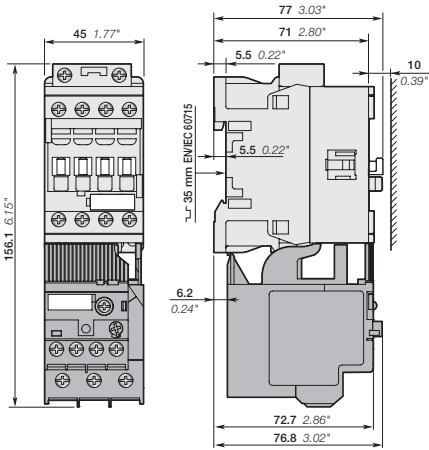

AF09, AF12, AF16
+ TF42

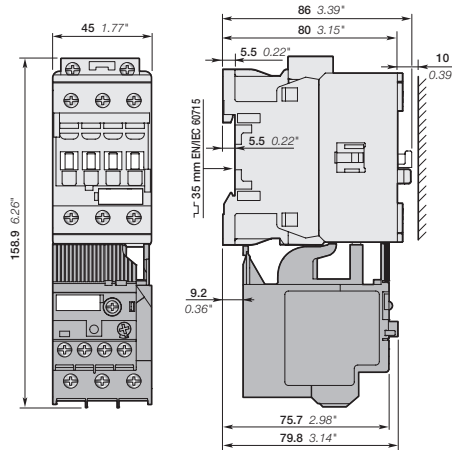

AF26, AF30, AF38
+ TF42

Reversing Starters

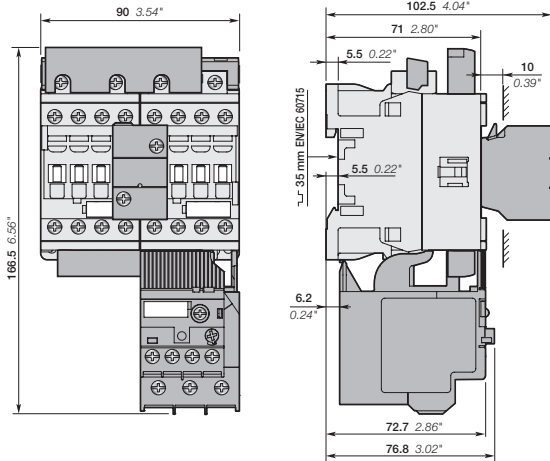

AF09, AF12, AF16
+ BER16-4, VEM4
+ TF42

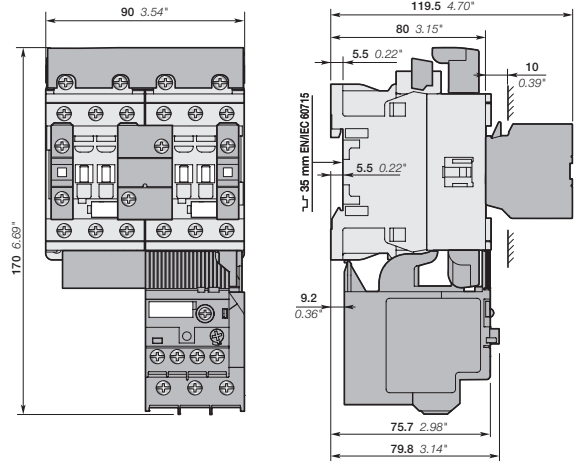

AF26, AF30, AF38
+ BER38-4, VEM4, CA4-10
+ TF42

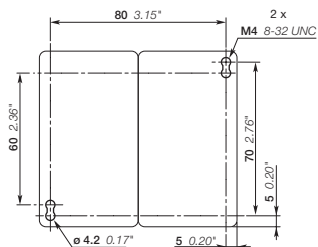

Note: contactor lateral distance to grounded component 2 mm 0.08" min.

Star-Delta Starters Protected by Thermal Overload Relay With AF Contactors - Open Type Version in Kit Form



Dimensions (mm, inches)

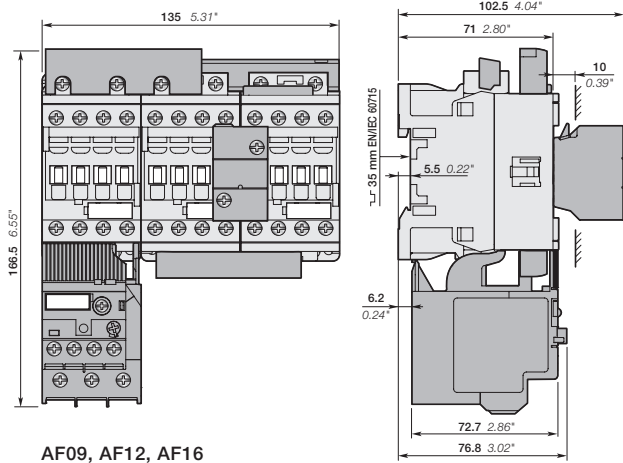

AF09, AF12, AF16
+ BEY16-4, VEM4
+ TF42

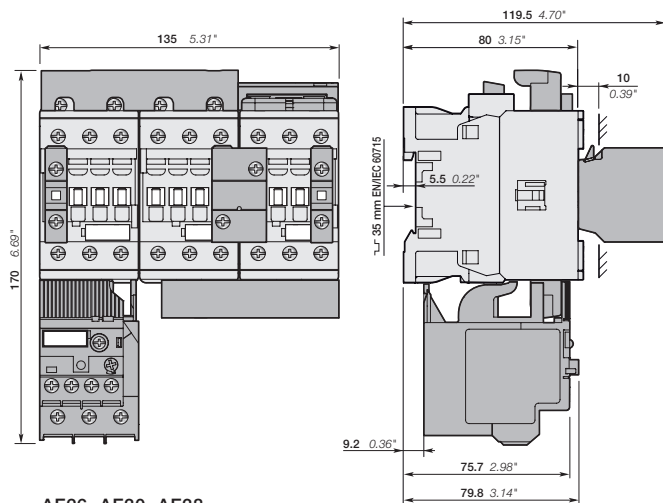

AF26, AF30, AF38
+ BEY38-4, VEM4, CA4-10
+ TF42

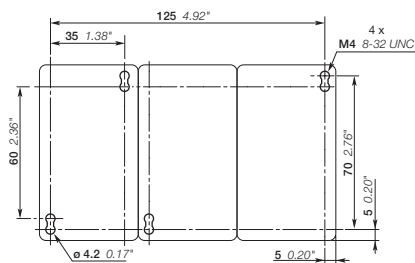

Note: contactor lateral distance to grounded component 2 mm 0.08" min.

Motor Starting Solutions Open Type Version, in Kit Form

Softstarter Protected by Manual Motor Starters



Switching of 3-phase Cage Motors

Rated power - AC-53a, 400 V		0.25 ... 15 kW
Short-circuit current I_k		16 kA - 50 kA
Coordination type		Type 1
Manual motor starters		MS116 ... MS132
Softstarters	AC / DC Operated	PSR3 ... PSR30

Softstarter Protected by Manual Motor Starters

Open Type Version in Kit Form

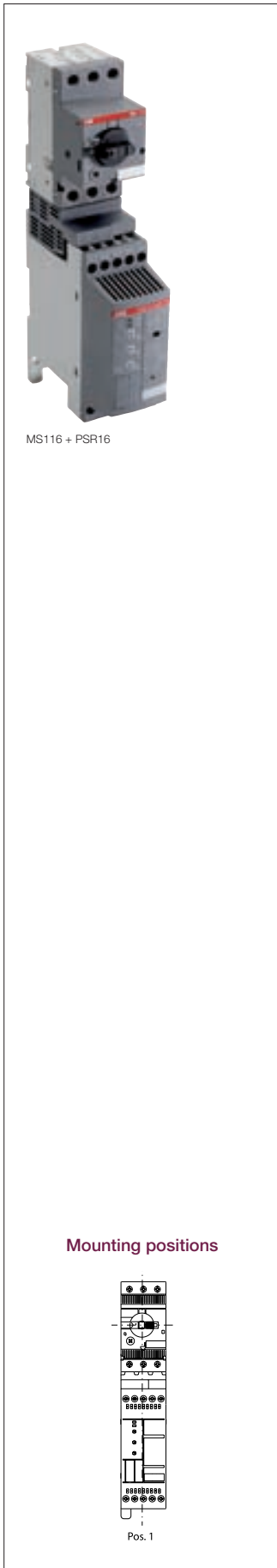

Application

Softstarters from **PSR3** up to **PSR30** are used for starting and stopping normal standard three phase motors. All applications benefit from soft starting as it reduces the starting current and limits the mechanical stresses when starting, giving the equipment a long life.

One of the most common applications is for the operation of pumps, where soft stopping can be used to avoid water hammering and damage to pipes.

Other common applications are for starting fans, compressors, conveyors, mixers and tooling machines.

Description

PSR softstarters reduce the main voltage during-start using electronically-controlled semiconductors. The **PSR** softstarters offer a very compact design thanks to the built-in by-pass contacts in the main circuit. Wide main voltage range from 208 to 600 V limits the need of variants as well as being very robust and insensitive for voltage variations. The range from 3 A up to 37 A is designed in three frame sizes. The compact design, clear marking and limited need for control wiring makes it easy to install.

Types

The **PSR** range offers types with 24 V DC as well as a 100...240 V AC supply voltage.

The complete range has a run signal contact, while sizes **PSR25 ... PSR30** also have a top of ramp signal (T.O.R.) indicating the end of the start run. Each size of the **PSR** softstarters can be combined with our manual motor starters (MMS) using the connection kits. This will result in a very compact starter combination.

Wiring Diagrams

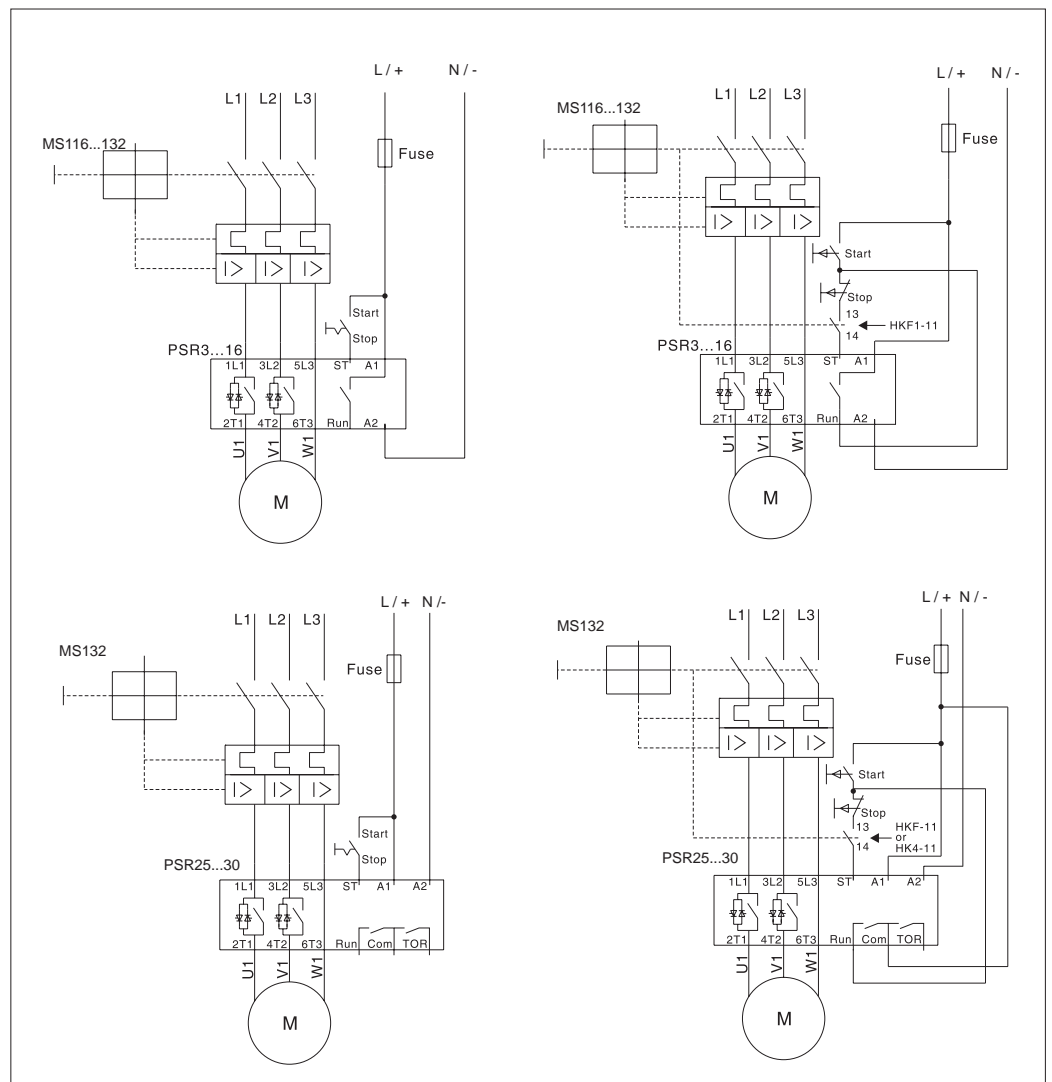

Softstarter Protected by Manual Motor Starter

Coordination type 1

Catalogue Page 1SBC 101 266 S0201

		AC-53a
		400 V

Coordination Type 1, AC-53a, 16 kA, 400 V, 50/60 Hz, IEC/EN 60947-4-2

		Manual Motor Starters				Connection Kit		Softstarter				
		Type	Order code	Current setting range	Magnetic tripping current	Type	Order code	Aux. Con./ToR	Control voltage	Type	Order code	
IEC AC-53a, 400 V Rated power kW	Rated current A			A	A				V AC 50/60 Hz	V DC		
									—	—		
0.25	0.85	MS116-1.0	1SAM 250 000 R1005	0.63...1.00	11.5	PSR16-MS116	1SFA 896 211 R1001	1	100...240	—	PSR3-600-70	1SFA 896 103 R7000
									—	24	PSR3-600-81	1SFA 896 103 R8100
0.37	1.1	MS116-1.6	1SAM 250 000 R1006	1.00...1.60	18.4	PSR16-MS116	1SFA 896 211 R1001	1	100...240	—	PSR3-600-70	1SFA 896 103 R7000
									—	24	PSR3-600-81	1SFA 896 103 R8100
0.55	1.5	MS116-1.6	1SAM 250 000 R1006	1.00...1.60	18.4	PSR16-MS116	1SFA 896 211 R1001	1	100...240	—	PSR3-600-70	1SFA 896 103 R7000
									—	24	PSR3-600-81	1SFA 896 103 R8100
0.75	1.9	MS116-2.5	1SAM 250 000 R1007	1.60...2.50	28.75	PSR16-MS116	1SFA 896 211 R1001	1	100...240	—	PSR3-600-70	1SFA 896 103 R7000
									—	24	PSR3-600-81	1SFA 896 103 R8100
1.1	2.7	MS116-4.0	1SAM 250 000 R1008	2.50...4.00	50	PSR16-MS116	1SFA 896 211 R1001	1	100...240	—	PSR3-600-70	1SFA 896 103 R7000
									—	24	PSR3-600-81	1SFA 896 103 R8100
1.5	3.6	MS116-4.0	1SAM 250 000 R1008	2.50...4.00	50	PSR16-MS116	1SFA 896 211 R1001	1	100...240	—	PSR3-600-70	1SFA 896 103 R7000
									—	24	PSR3-600-81	1SFA 896 103 R8100
2.2	4.9	MS116-6.3	1SAM 250 000 R1009	4.00...6.30	78.75	PSR16-MS116	1SFA 896 211 R1001	1	100...240	—	PSR6-600-70	1SFA 896 104 R7000
									—	24	PSR6-600-81	1SFA 896 104 R8100
3	6.5	MS116-10	1SAM 250 000 R1010	6.30...10.00	150	PSR16-MS116	1SFA 896 211 R1001	1	100...240	—	PSR6-600-70	1SFA 896 104 R7000
									—	24	PSR6-600-81	1SFA 896 104 R8100
4	8.5	MS116-10	1SAM 250 000 R1010	6.30...10.00	150	PSR16-MS116	1SFA 896 211 R1001	1	100...240	—	PSR9-600-70	1SFA 896 105 R7000
									—	24	PSR9-600-81	1SFA 896 105 R8100
5.5	11.5	MS116-12	1SAM 250 000 R1012	8.00...12.00	180	PSR16-MS116	1SFA 896 211 R1001	1	100...240	—	PSR12-600-70	1SFA 896 106 R7000
									—	24	PSR12-600-81	1SFA 896 106 R8100
7.5	15.5	MS116-16	1SAM 250 000 R1011	10.00...16.00	240	PSR16-MS116	1SFA 896 211 R1001	1	100...240	—	PSR16-600-70	1SFA 896 107 R7000
									—	24	PSR16-600-81	1SFA 896 107 R8100
11	22	MS132-25	1SAM 350 000 R1014	20...25	375	PSR30-MS132	1SFA 896 212 R1001	1 / 1	100...240	—	PSR25-600-70	1SFA 896 108 R7000
									—	24	PSR25-600-81	1SFA 896 108 R8100
15	29	MS132-32	1SAM 350 000 R1015	25...32	480	PSR30-MS132	1SFA 896 212 R1001	1 / 1	100...240	—	PSR30-600-70	1SFA 896 109 R7000
									—	24	PSR30-600-81	1SFA 896 109 R8100

Main Accessories

	Type	Order code
Fieldbus Plug connection AccessoryThe same accessory for all sizes	PS-FBPA	1SFA 896 312 R1002
Connection kit for PSR3-16 and MS116	PSR16-MS116	1SFA 896 211 R1001
Connection kit for PSR30-16 and MS132	PSR30-MS132	1SFA 896 212 R1001
Fan for PSR3-45	PSR-FAN3-45A	1SFA 896 311 R1001

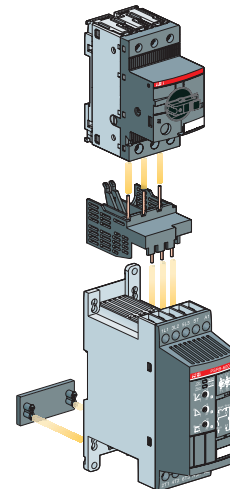

Softstarter Protected by Manual Motor Starter

Coordination type 1



Coordination Type 1, AC-53a, 50 kA, 400 V, 50/60 Hz, IEC/EN 60947-4-2

		Manual Motor Starters				Connection Kit		Softstarter				
IEC	Type	Order code	Current setting range	Magnetic tripping current	Type	Order code	Aux. Con./ToR	Control voltage		Type	Order code	
								V AC 50/60 Hz	V DC			
Rated power kW	Rated current A		A	A								
0.25	0.85	MS116-1.0	1SAM 250 000 R1005	0.63...1.00	11.5	PSR16-MS116	1SFA 896 211 R1001	1	100...240	—	PSR3-600-70	1SFA 896 103 R7000
									—	24	PSR3-600-81	1SFA 896 103 R8100
0.37	1.1	MS116-1.6	1SAM 250 000 R1006	1.00...1.60	18.4	PSR16-MS116	1SFA 896 211 R1001	1	100...240	—	PSR3-600-70	1SFA 896 103 R7000
									—	24	PSR3-600-81	1SFA 896 103 R8100
0.55	1.5	MS116-1.6	1SAM 250 000 R1006	1.00...1.60	18.4	PSR16-MS116	1SFA 896 211 R1001	1	100...240	—	PSR3-600-70	1SFA 896 103 R7000
									—	24	PSR3-600-81	1SFA 896 103 R8100
0.75	1.9	MS116-2.5	1SAM 250 000 R1007	1.60...2.50	28.75	PSR16-MS116	1SFA 896 211 R1001	1	100...240	—	PSR3-600-70	1SFA 896 103 R7000
									—	24	PSR3-600-81	1SFA 896 103 R8100
1.1	2.7	MS116-4.0	1SAM 250 000 R1008	2.50...4.00	50	PSR16-MS116	1SFA 896 211 R1001	1	100...240	—	PSR3-600-70	1SFA 896 103 R7000
									—	24	PSR3-600-81	1SFA 896 103 R8100
1.5	3.6	MS116-4.0	1SAM 250 000 R1008	2.50...4.00	50	PSR16-MS116	1SFA 896 211 R1001	1	100...240	—	PSR3-600-70	1SFA 896 103 R7000
									—	24	PSR3-600-81	1SFA 896 103 R8100
2.2	4.9	MS116-6.3	1SAM 250 000 R1009	4.00...6.30	78.75	PSR16-MS116	1SFA 896 211 R1001	1	100...240	—	PSR6-600-70	1SFA 896 104 R7000
									—	24	PSR6-600-81	1SFA 896 104 R8100
3	6.5	MS116-10	1SAM 250 000 R1010	6.30...10.00	150	PSR16-MS116	1SFA 896 211 R1001	1	100...240	—	PSR6-600-70	1SFA 896 104 R7000
									—	24	PSR6-600-81	1SFA 896 104 R8100
4	8.5	MS116-10	1SAM 250 000 R1010	6.30...10.00	150	PSR16-MS116	1SFA 896 211 R1001	1	100...240	—	PSR9-600-70	1SFA 896 105 R7000
									—	24	PSR9-600-81	1SFA 896 105 R8100
5.5	11.5	MS132-12	1SAM 350 000 R1012	8.00...12.00	180	PSR16-MS116	1SFA 896 211 R1001	1	100...240	—	PSR12-600-70	1SFA 896 106 R7000
									—	24	PSR12-600-81	1SFA 896 106 R8100
7.5	15.5	MS132-16	1SAM 350 000 R1011	10.00...16.00	240	PSR16-MS116	1SFA 896 211 R1001	1	100...240	—	PSR16-600-70	1SFA 896 107 R7000
									—	24	PSR16-600-81	1SFA 896 107 R8100
11	22	MS132-25	1SAM 350 000 R1014	20...25	375	PSR30-MS132	1SFA 896 212 R1001	1/1	100...240	—	PSR25-600-70	1SFA 896 108 R7000
									—	24	PSR25-600-81	1SFA 896 108 R8100
15	29	MS132-32	1SAM 350 000 R1015	25...32	480	PSR30-MS132	1SFA 896 212 R1001	1/1	100...240	—	PSR30-600-70	1SFA 896 109 R7000
									—	24	PSR30-600-81	1SFA 896 109 R8100

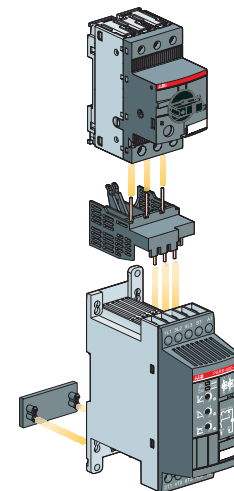

Softstarter Protected by Manual Motor Starter

Open Type Version in Kit Form



Dimensions mm, inches

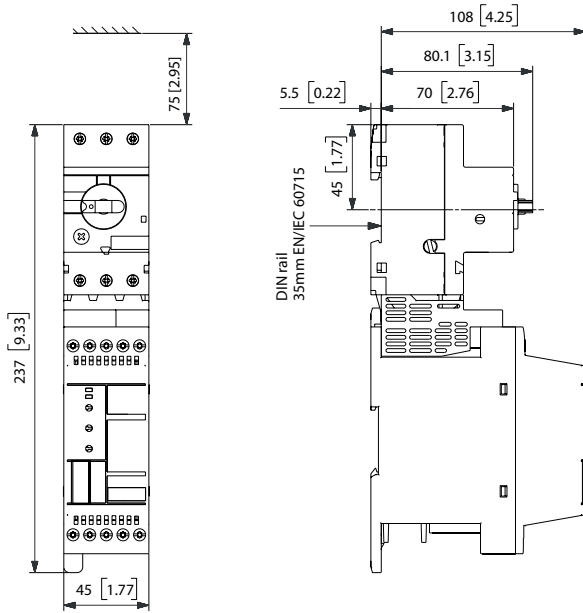

MS116 + PSR16-MS116 + PSR3 ... PSR16

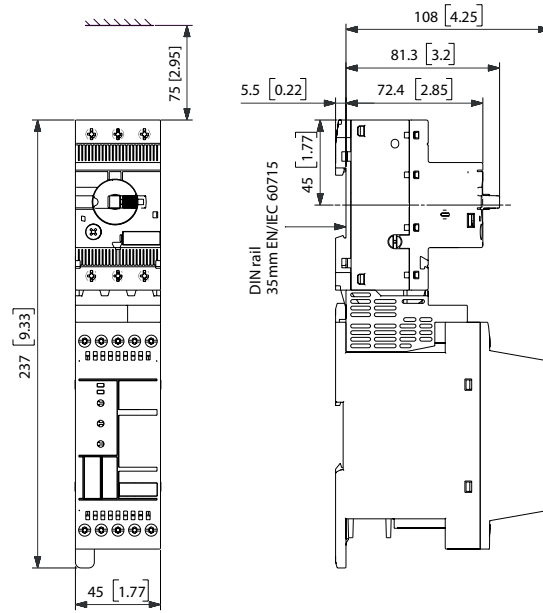

MS132-0.16 ... MS132-10 + PSR16-MS116 + PSR3 ... PSR16

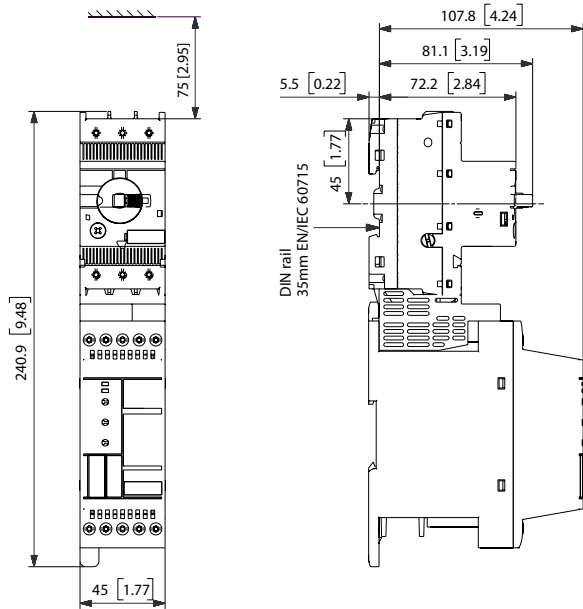

MS132-12 ... MS132-32 + PSR16-MS116 + PSR3 ... PSR16

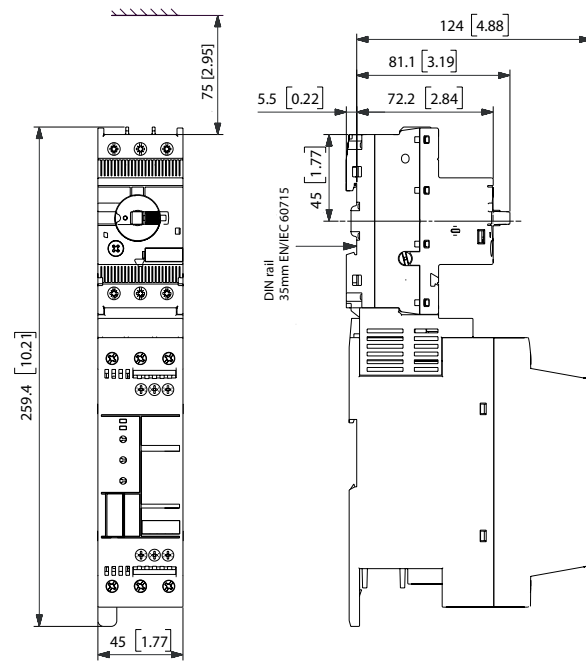

MS132-12 ... MS132-32 + PSR30-MS132 + PSR25 ... PSR30

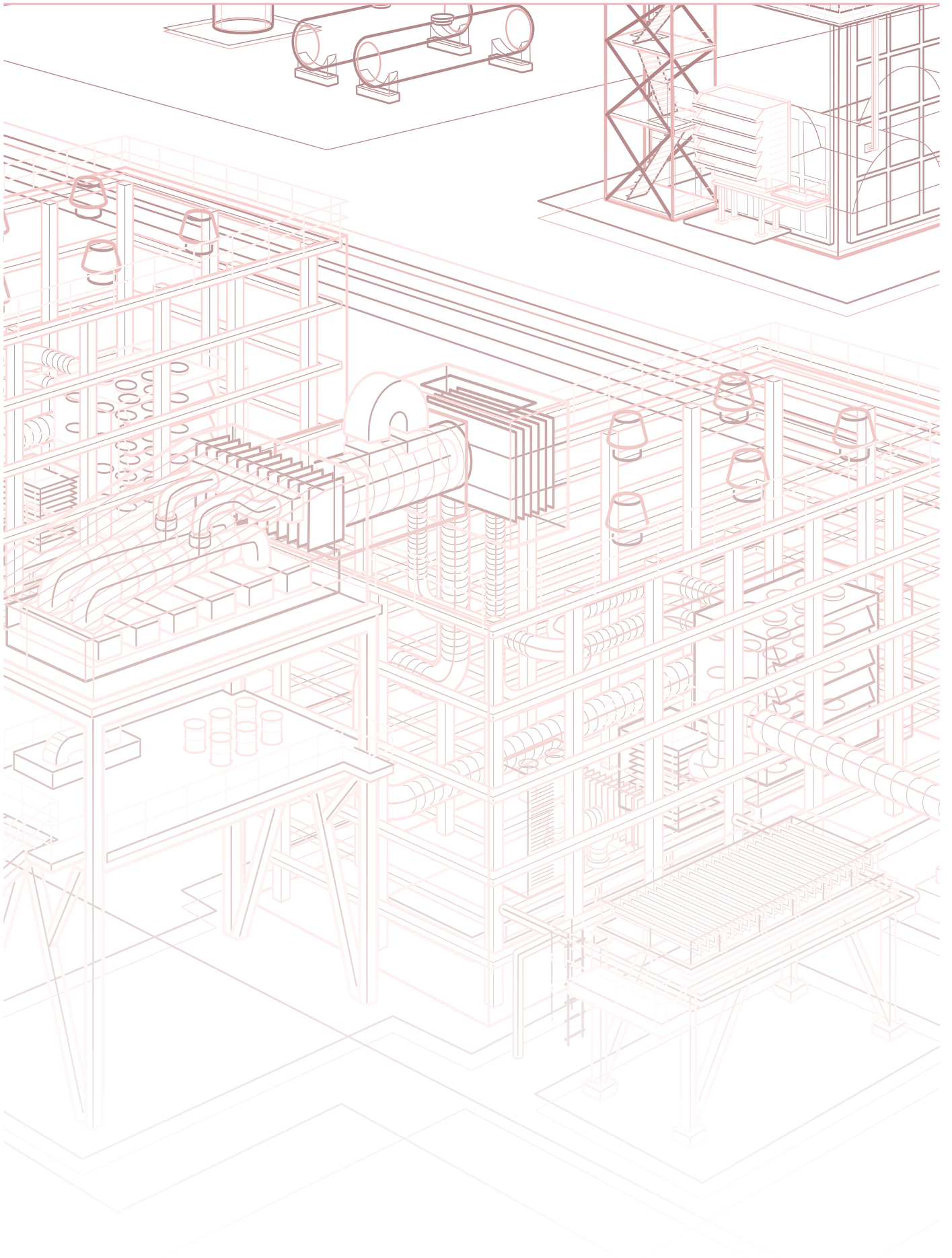

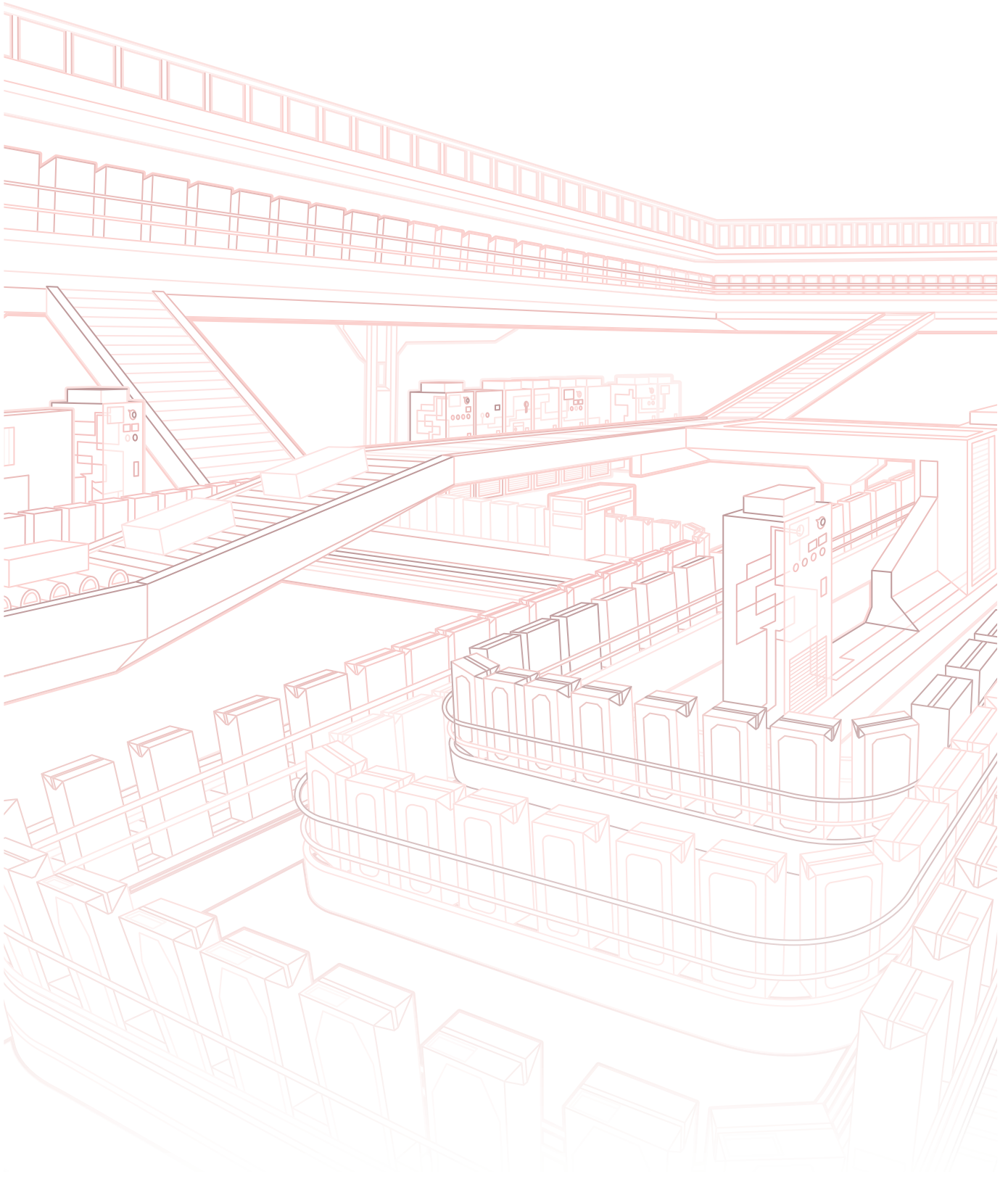

Motor Protection and Control up to 18.5 kW / 20 hp

Manual Motor Starters

Overview	44
-----------------------	----

MS116 Manual Motor Starter - up to 16 A

Ordering Details	46
------------------------	----

Main Technical Data	47
---------------------------	----

MS132 Manual Motor Starter - up to 32 A

Ordering Details	48
------------------------	----

Main Technical Data	49
---------------------------	----

Main Accessory Ordering Details	50
---------------------------------------	----

Dimensions	54
------------------	----

Contactors and Overload Relays

AF09 ... AF38 3-pole Contactors

Overview	56
-----------------------	----

Ordering Details	58
------------------------	----

Main Technical Data	59
---------------------------	----

Main Accessory Fitting Details	60
--------------------------------------	----

Main Accessory Ordering Details	61
---------------------------------------	----

Dimensions	62
------------------	----

TF42 Thermal Overload Relays

Ordering Details	64
------------------------	----

Main Technical Data	65
---------------------------	----

Dimensions	64
------------------	----

EF19 and EF45 Electronic Overload Relays

Ordering Details	66
------------------------	----

Main Technical Data	67
---------------------------	----

Dimensions	66
------------------	----

AF09 ... AF38 4-pole Contactors

Overview	69
-----------------------	----

Ordering Details	70
------------------------	----

Main Technical Data	71
---------------------------	----

Main Accessory Fitting Details	72
--------------------------------------	----

Main Accessory Ordering Details	73
---------------------------------------	----

Dimensions	74
------------------	----

NF Contactor Relays

Overview	77
-----------------------	----

Ordering Details	78
------------------------	----

Main Technical Data	79
---------------------------	----

Main Accessory Fitting Details	80
--------------------------------------	----

Main Accessory Ordering Details	81
---------------------------------------	----

Dimensions	82
------------------	----

PSR Softstarters

Ordering Details	84
------------------------	----

Main Technical Data	85
---------------------------	----

Main Accessory Ordering Details	86
---------------------------------------	----

Dimensions	87
------------------	----



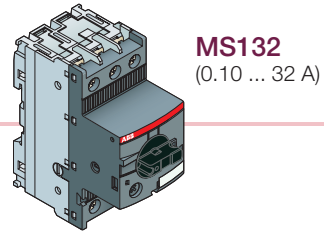
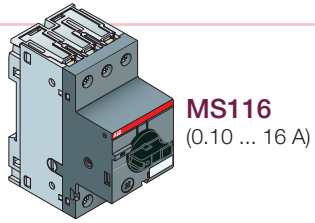

for **Manual Motor Starters**

Main Accessories

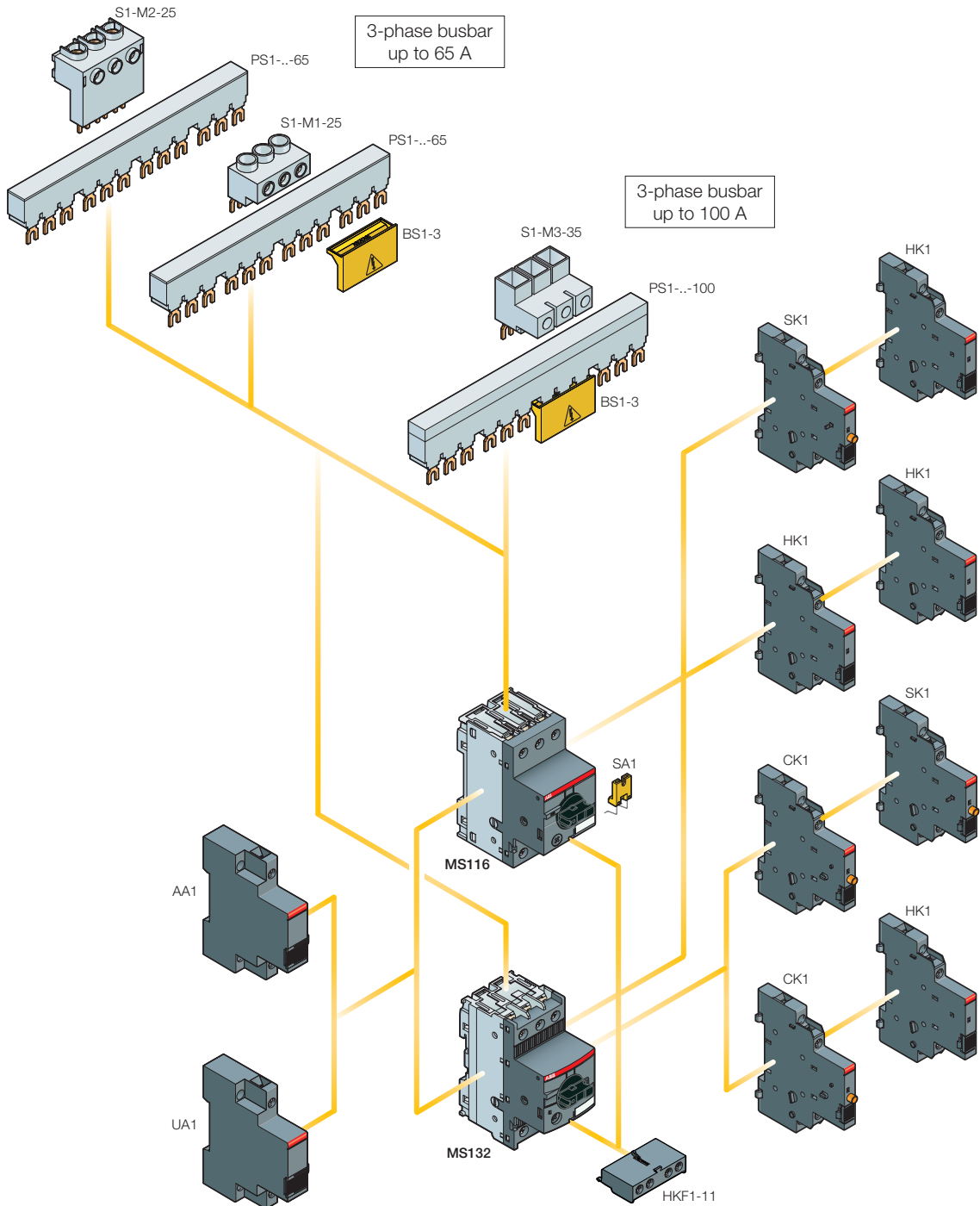

Manual Motor Starters



Certifications and approvals

Electromagnetic trip a multiple of the rated current	
Phase loss sensitivity	
Switch position	
Magnetic trip indication	
Lockable handle without accessories	
Disconnecting feature	
Width	
Setting range	
Rated operational voltage U_e	
Rated frequency	
Trip class	
Short-circuit breaking capacity I_{cs}	400 V
Ambient air temperature open compensated	

MS116	
9.75 ... 15 x I_n	
yes	
ON/OFF	
-	
-	
yes	
45 mm	
0.1 ... 16 A	
690 V AC	
50 Hz / 60 Hz	
10A	
up to 50 kA	
-25 ... +55 °C	

MS132	
9.75 ... 15 x I_n	
yes	
ON/OFF/TRIP	
yes	
yes	
yes	
45 mm	
0.1 ... 32 A	
690 V AC	
50 Hz / 60 Hz	
10	
up to 100 kA	
-25 ... +60 °C	

Main Accessories

Auxiliary contacts	Front mounting		HKF1
	Side mounting		HK1
Signaling contacts	Tripped alarm		SK1
	Short-circuit alarm		CK1
Auxiliary trip units	Shunt trip		AA1
	Undervoltage release		UA1
Busbar systems	3-phase busbar		PS1
	Feeder terminals		S1

MS116 Manual Motor Starter

With Thermal and Electromagnetic Protection

Catalogue Page 1SBC 101 079 S0201



0.10 ... 16.0 A
Class 10A

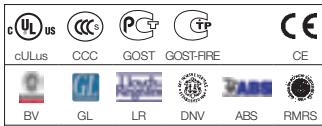

MS116

Application

- Short-circuit protection
- Overload protection
- Trip class 10A
- Phase loss sensitivity
- ON/OFF switching functionality
- Disconnecting feature
- Suitable for three- and single phase applications

Description

- 45 mm width
- One range of common accessories for MS116 & MS132

Ordering Details

Rated power 400 V AC-3 kW	Setting ranges A ... A	Type	Order code	Short-circuit breaking capacity I_{cs} at 400 V AC kA	Rated instantaneous short-circuit current setting A	Pack ^(mg) pieces	Weight kg (1 pce)
0.03	0.10 ... 0.16	MS116-0.16	1SAM 250 000 R1001	50	1.25 ... 1.87	1	0.225
0.06	0.16 ... 0.25	MS116-0.25	1SAM 250 000 R1002	50	1.95 ... 2.92	1	0.225
0.09	0.25 ... 0.40	MS116-0.4	1SAM 250 000 R1003	50	3.12 ... 4.68	1	0.225
0.12	0.40 ... 0.63	MS116-0.63	1SAM 250 000 R1004	50	4.91 ... 7.37	1	0.225
0.25	0.63 ... 1.00	MS116-1.0	1SAM 250 000 R1005	50	9.20 ... 13.8	1	0.225
0.55	1.00 ... 1.60	MS116-1.6	1SAM 250 000 R1006	50	14.7 ... 22.1	1	0.265
0.75	1.60 ... 2.50	MS116-2.5	1SAM 250 000 R1007	50	23.0 ... 34.5	1	0.265
1.5	2.50 ... 4.00	MS116-4.0	1SAM 250 000 R1008	50	40.0 ... 60.0	1	0.265
2.2	4.00 ... 6.30	MS116-6.3	1SAM 250 000 R1009	50	63.0 ... 94.5	1	0.265
4	6.30 ... 10.0	MS116-10	1SAM 250 000 R1010	50	120 ... 180	1	0.265
5.5	8.00 ... 12.0	MS116-12	1SAM 250 000 R1012	25	144 ... 216	1	0.265
7.5	10.0 ... 16.0	MS116-16	1SAM 250 000 R1011	16	192 ... 288	1	0.265

Short-circuit protection MS116

Setting ranges, short-circuit breaking capacity and max. back-up fuses

Maximum rated current of the back-up fuses if $I_{cc} > I_{cs}$ (1)

Setting ranges A ... A	230 V AC			400 V AC			440 V AC			500 V AC			690 V AC		
	I_{cu} kA	I_{cs} kA	gG, aM A	I_{cu} kA	I_{cs} kA	gG, aM A	I_{cu} kA	I_{cs} kA	gG, aM A	I_{cu} kA	I_{cs} kA	gG, aM A	I_{cu} kA	I_{cs} kA	gG, aM A
0.10 ... 0.16	No back-up fuse required up to $I_{cc} = 50$ kA						No back-up fuse required up to $I_{cc} = 30$ kA								
0.16 ... 0.25															
0.25 ... 0.40															
0.40 ... 0.63															
0.63 ... 1.00															
1.00 ... 1.60															
1.60 ... 2.50						10	10	25	10	10	25	5	5	25	
2.50 ... 4.00						6	6	25	6	6	25	2	2	25	
4.00 ... 6.30						6	6	63	6	6	63	2	2	40	
6.30 ... 10.0						6	6	63	6	6	63	2	2	50	
8.00 ... 12.0	25	25	80	25	25	80	6	6	63	6	6	63	2	2	50
10.0 ... 16.0	16	16	80	16	16	80	4	4	63	4	4	63	2	2	63

(1) I_{cs} = Rated service short-circuit breaking capacity,
 I_{cu} = Rated ultimate short-circuit breaking capacity,
 I_{cc} = Prospective short-circuit current at installation location,
 $I_{cu} = I_{cs}$ in the case of MS116.



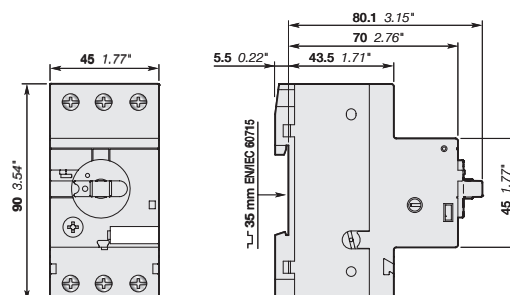

Main Dimensions mm, inches



Technical Data

	0.10 ... 16.0 A
	Class 10A

Main Technical Data

Manual Motor Starter Types		MS116		
Standards	Conformity to standards	IEC/EN60947-1, IEC/EN60947-2, IEC/EN60947-4-1, UL 508, CSA C22.2 No. 14		
	Phase loss sensitivity (acc. to IEC/EN 60947-4-1)	yes		
	Disconnecting feature (acc. to IEC/EN 60947-2)	yes		
General data	Mounting position	Position 1-6		
	Degree of protection (acc. to IEC 60947-1)	IP 20		
	Mechanical durability	100000 cycles		
	Electrical durability	100000 cycles		
	Utilization category	A		
IEC				
Main circuit	Rated operational voltage U_e	690 V AC		
	Rated operational current I_e	up to 16 A		
	Rated frequency	50 / 60 Hz		
	Trip class	10A		
Isolation data (acc. to IEC/EN 60947-1)	Rated impulse withstand voltage U_{imp}	6 kV		
	Rated insulation voltage U_i	690 V		
Environmental data	Ambient air temperature			
	Operation	Open - compensated	-25 ... +55 °C	
		Open	-25 ... +70 °C	
		Enclosed (IB132)	0 ... +40 °C	
	Storage	-50 ... +80 °C		
	Vibration (acc. to IEC/EN 60068-2-6)	5 g / 3-150 Hz		
Shock (acc. to IEC/EN 60068-2-27)	25 g / 11 ms			
Connecting capacity	 Rigid	1 or 2 x	1 ... 4 mm ²	
	 Flexible with ferrule	1 or 2 x	0.75 ... 2.5 mm ²	
	 Flexible without ferrule	1 or 2 x	0.75 ... 2.5 mm ²	
	Stripping length	9 mm		
	Tightening torque	0.8 ... 1.2 Nm		
UL/CSA				
Main circuit	Max. operational voltage	600 V AC		
	Short-circuit rating	480 V AC	0.16 A ≤ I_e ≤ 2.5 A	30 kA
		600 V AC	2.5 A < I_e ≤ 16 A	18 kA
Connecting capacity	 Stranded	1 or 2 x	AWG 16 ... 12	
	 Flexible without ferrule	1 or 2 x	AWG 16 ... 12	
	Stripping length	9 mm		
	Tightening torque	10 lb.in		

MS132 Manual Motor Starter

With Thermal and Electromagnetic Protection

Catalogue Page 1SBC 101 090 S0202



0.10 ... 32.0 A
Class 10

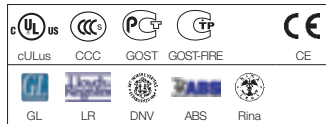

MS132-10



MS132-32

Application

- Short-circuit protection
- Overload protection
- Trip class 10
- Phase loss sensitivity
- ON/OFF switching functionality
- Disconnecting feature
- Suitable for three- and single phase applications

Description

- 45 mm width
- Lockable handle
- Clear position of the handle ON/OFF/TRIP
- Magnetic tripping optically signalled in the front
- One range of common accessories for MS116 & MS132

Ordering Details

Rated power 400 V AC-3 kW	Setting ranges A ... A	Type	Order code	Short-circuit breaking capacity I_{cs} at 400 V AC kA	Rated instantaneous short-circuit current setting A	Pack ^(mg) pieces	Weight kg (1 pce)
0.03	0.10 ... 0.16	MS132-0.16	1SAM 350 000 R1001	100	1.25 ... 1.87	1	0.215
0.06	0.16 ... 0.25	MS132-0.25	1SAM 350 000 R1002	100	1.95 ... 2.92	1	0.215
0.09	0.25 ... 0.40	MS132-0.4	1SAM 350 000 R1003	100	3.12 ... 4.68	1	0.215
0.12	0.40 ... 0.63	MS132-0.63	1SAM 350 000 R1004	100	4.91 ... 7.37	1	0.215
0.25	0.63 ... 1.00	MS132-1.0	1SAM 350 000 R1005	100	9.20 ... 13.8	1	0.215
0.55	1.00 ... 1.60	MS132-1.6	1SAM 350 000 R1006	100	14.7 ... 22.1	1	0.265
0.75	1.60 ... 2.50	MS132-2.5	1SAM 350 000 R1007	100	23.0 ... 34.5	1	0.265
1.5	2.50 ... 4.00	MS132-4.0	1SAM 350 000 R1008	100	40.0 ... 60.0	1	0.265
2.2	4.00 ... 6.30	MS132-6.3	1SAM 350 000 R1009	100	63.0 ... 94.5	1	0.265
4	6.30 ... 10.0	MS132-10	1SAM 350 000 R1010	100	120 ... 180	1	0.265
5.5	8.00 ... 12.0	MS132-12	1SAM 350 000 R1012	100	144 ... 216	1	0.310
7.5	10.0 ... 16.0	MS132-16	1SAM 350 000 R1011	100	192 ... 288	1	0.310
9	16.0 ... 20.0	MS132-20	1SAM 350 000 R1013	100	240 ... 360	1	0.310
12.5	20.0 ... 25.0	MS132-25	1SAM 350 000 R1014	50	300 ... 450	1	0.310
15	25.0 ... 32.0	MS132-32	1SAM 350 000 R1015	25	384 ... 576	1	0.310

Short-circuit protection MS132

Setting ranges, short-circuit breaking capacity and max. back-up fuses

Maximum rated current of the back-up fuses if $I_{cc} > I_{cs}$ (1)

Setting ranges A ... A	230 V AC			400 V AC			690 V AC		
	I_{cu} kA	I_{cs} kA	gG, aM A	I_{cu} kA	I_{cs} kA	gG, aM A	I_{cu} kA	I_{cs} kA	gG, aM A
0.10 ... 0.16									
0.16 ... 0.25									
0.25 ... 0.40									
0.40 ... 0.63									
0.63 ... 1.00									
1.00 ... 1.60									
1.60 ... 2.50									
2.50 ... 4.00							3	3	(2)
4.00 ... 6.30							3	3	(2)
6.30 ... 10.0							3	3	(2)
8.00 ... 12.0							3	3	(2)
10.0 ... 16.0							3	3	(2)
16.0 ... 20.0							3	3	(2)
20.0 ... 25.0	50	50	100	50	50	100	3	3	(2)
25.0 ... 32.0	50	25	125	50	25	125	3	3	(2)

No back-up fuse required up to $I_{cc} = 100$ kA

- (1) I_{cs} = Rated service short-circuit breaking capacity,
 I_{cu} = Rated ultimate short-circuit breaking capacity,
 I_{cc} = Prospective short-circuit current at installation location.
- (2) On request.

Main Dimensions mm, inches

MS132-0.16 ... MS132-10

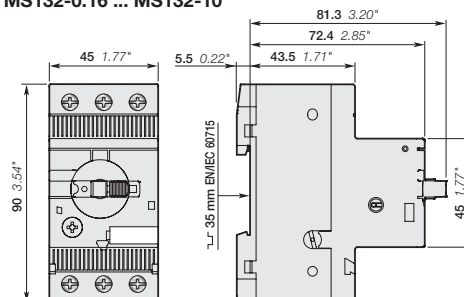



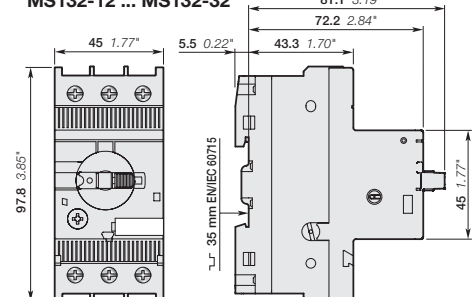

MS132-12 ... MS132-32



Technical Data

	0.10 ... 32.0 A
	Class 10

Main Technical Data

Manual Motor Starter Types		MS132			
		up to 10 A	up to 16 A	up to 32 A	
Standards	Conformity to standards	IEC/EN60947-1, IEC/EN60947-2, IEC/EN60947-4-1, UL 508, CSA C22.2 No. 14			
	Phase loss sensitivity (acc. to IEC/EN 60947-4-1)	yes			
	Disconnecting feature (acc. to IEC/EN 60947-2)	yes			
General data	Mounting position	Position 1-6			
	Degree of protection (acc. to IEC 60947-1)	IP 20			
	Mechanical durability	100000 cycles			
	Electrical durability	50000 cycles			
	Utilization category	A			
IEC					
Main circuit	Rated operational voltage U_e (acc. to IEC/EN 60947-1)	AC	690 V AC		
		DC	250 V DC		
	Rated operational current I_e	up to 10 A	up to 16 A	up to 32 A	
	Rated operational current DC-5 I_e 3 conducting paths in series up to 250 V	see "Rated operational current"			
	Rated service short-circuit breaking capacity DC I_{cs} 3 conducting paths in series up to 250 V	10 kA			
	Rated frequency	DC, 50 / 60 Hz			
	Trip class	10 (10A for MS132-0.16)	10	10	
	Isolation data (acc. to IEC/EN 60947-1)	Rated impulse withstand voltage U_{imp}	6 kV		
Rated insulation voltage U_i		690 V			
Environmental data	Ambient air temperature				
	Operation	Open - compensated	-25 ... +60 °C		
		Open	-25 ... +70 °C		
		Enclosed (IB132)	0 ... +40 °C		
	Storage		-50 ... +80 °C		
	Vibration (acc. to IEC/EN 60068-2-6)	5 g / 3-150 Hz			
Shock (acc. to IEC/EN 60068-2-27)	25 g / 11 ms				
Connecting capacity	 Rigid	1 or 2 x	1 ... 4 mm ²	1 ... 4 mm ²	2.5 ... 6 mm ²
	 Flexible with ferrule	1 or 2 x	0.75 ... 2.5 mm ²	0.75 ... 2.5 mm ²	1 ... 6 mm ²
	 Flexible without ferrule	1 or 2 x	0.75 ... 2.5 mm ²	0.75 ... 2.5 mm ²	1 ... 6 mm ²
	Stripping length		9 mm	10 mm	10 mm
	Tightening torque		0.8 ... 1.2 Nm	1.5 Nm	2.0 Nm
UL/CSA					
Main circuit	Max. operational voltage		600 V AC		
	Short-circuit rating	480 V AC	30 kA		
		600 V AC	18 kA		
Connecting capacity	 Stranded	1 or 2 x	AWG 16 ... 12	AWG 16 ... 12	AWG 12 ... 8
	 Flexible without ferrule	1 or 2 x	AWG 16 ... 12	AWG 16 ... 12	AWG 12 ... 8
	Stripping length		9 mm	10 mm	10 mm
	Tightening torque		10 ... 12 lb.in	14 lb.in	18 lb.in

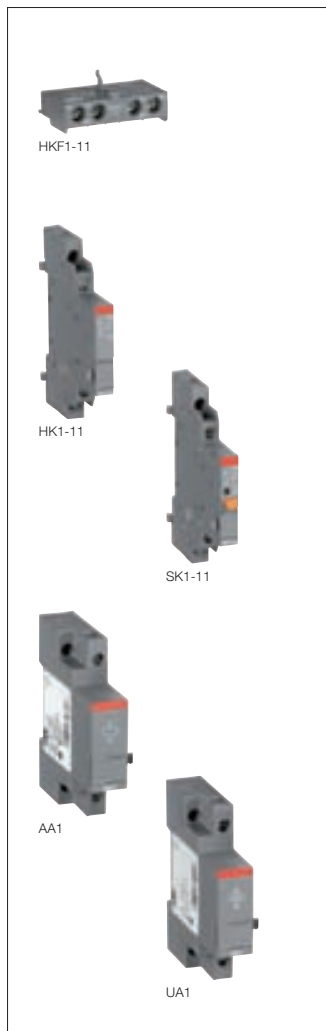

Auxiliary contacts

Manual Motor Starters		Aux. contacts		Type	Order code	Pack ^(ing) pieces	Weight kg (1 pce)
MS116	MS132	N.O.	N.C.				
Auxiliary contacts, mountable on front							
•	•	1	1	HKF1-11	1SAM 201 901 R1001	10	0.016
Auxiliary contacts, mountable on the right, max. 2 pieces							
•	•	1	1	HK1-11	1SAM 201 902 R1001	2	0.035
•	•	2	0	HK1-20	1SAM 201 902 R1002	2	0.035
•	•	0	2	HK1-02	1SAM 201 902 R1003	2	0.035
Auxiliary contacts with lead contacts, mountable on the right, also to use with undervoltage release							
•	•	2	0	HK1-20L	1SAM 201 902 R1004	2	0.035

Signaling contacts

Signaling contacts for tripped alarm, mountable on the right							
•	•	1	1	SK1-11	1SAM 201 903 R1001	2	0.035
•	•	2	0	SK1-20	1SAM 201 903 R1002	2	0.035
•	•	0	2	SK1-02	1SAM 201 903 R1003	2	0.035
Signaling contacts for short-circuit alarm, mountable on the right							
-	•	1	1	CK1-11	1SAM 301 901 R1001	2	0.035
-	•	2	0	CK1-20	1SAM 301 901 R1002	2	0.035
-	•	0	2	CK1-02	1SAM 301 901 R1003	2	0.035

Auxiliary trip units

Manual Motor Starters		Rated control supply voltage	Type	Order code	Pack ^(ing) pieces	Weight kg (1 pce)
MS116	MS132					
Shunt trip, mountable on the left						
•	•	24 V 50/60 Hz	AA1-24	1SAM 201 910 R1001	1	0.100
•	•	110 V 50/60 Hz	AA1-110	1SAM 201 910 R1002	1	0.100
•	•	200 ... 240 V 50/60 Hz	AA1-230	1SAM 201 910 R1003	1	0.100
•	•	350 ... 415 V 50/60 Hz	AA1-400	1SAM 201 910 R1004	1	0.100
Undervoltage release, mountable on the left						
•	•	24 V 50 Hz	UA1-24	1SAM 201 904 R1001	1	0.100
•	•	48 V 50 Hz	UA1-48	1SAM 201 904 R1002	1	0.100
•	•	60 V 50 Hz	UA1-60	1SAM 201 904 R1003	1	0.100
•	•	110 V 50 Hz - 120 V 60 Hz	UA1-120	1SAM 201 904 R1004	1	0.100
•	•	208 V 60 Hz	UA1-208	1SAM 201 904 R1008	1	0.100
•	•	230 V 50 Hz - 240 V 60 Hz	UA1-230	1SAM 201 904 R1005	1	0.100
•	•	400 V 50 Hz	UA1-400	1SAM 201 904 R1006	1	0.100
•	•	415 V 50 Hz - 480 V 60 Hz	UA1-415	1SAM 201 904 R1007	1	0.100

Manual motor starter with accessories

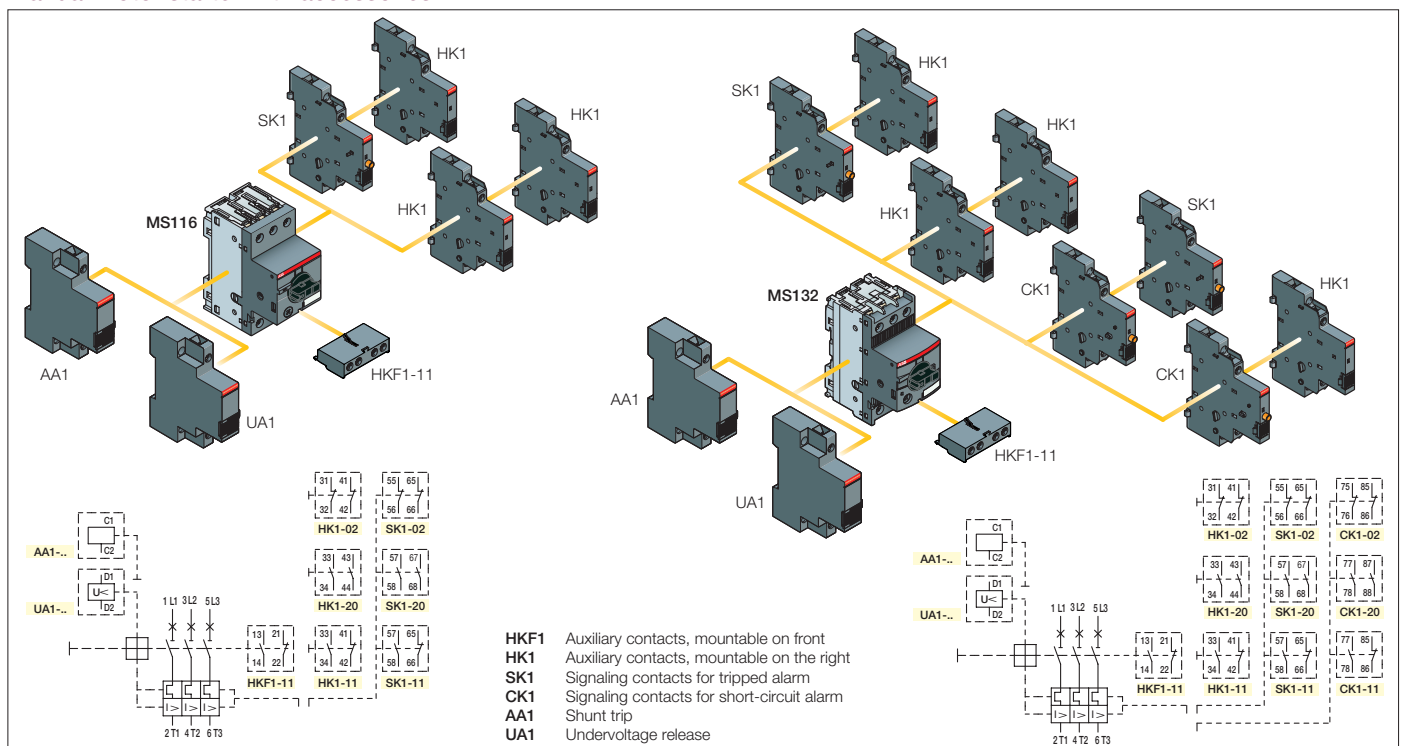

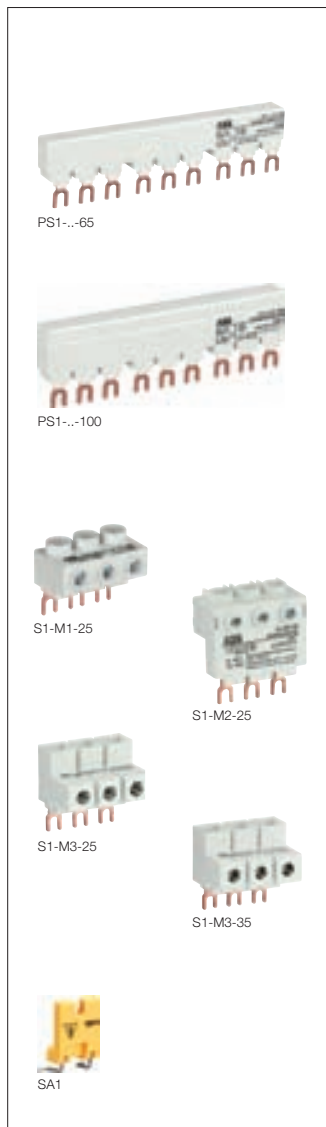

3-phase busbar systems

Manual Motor Starters	Number of MMS	Number of aux. contacts	Type	Order code	Pack ^(ing) pieces	Weight kg (1 pce)
MS116	MS132					
3-phase busbar up to 65 A						
•	•	2	0	PS1-2-0-65	1SAM 201 906 R1102	10 0.034
•	•	3	0	PS1-3-0-65	1SAM 201 906 R1103	10 0.055
•	•	4	0	PS1-4-0-65	1SAM 201 906 R1104	10 0.077
•	•	5	0	PS1-5-0-65	1SAM 201 906 R1105	10 0.098
•	•	2	1	PS1-2-1-65	1SAM 201 906 R1112	10 0.036
•	•	3	1	PS1-3-1-65	1SAM 201 906 R1113	10 0.060
•	•	4	1	PS1-4-1-65	1SAM 201 906 R1114	10 0.087
•	•	5	1	PS1-5-1-65	1SAM 201 906 R1115	10 0.108
•	•	2	2	PS1-2-2-65	1SAM 201 906 R1122	10 0.040
•	•	3	2	PS1-3-2-65	1SAM 201 906 R1123	10 0.067
•	•	4	2	PS1-4-2-65	1SAM 201 906 R1124	10 0.095
•	•	5	2	PS1-5-2-65	1SAM 201 906 R1125	10 0.122
3-phase busbar up to 100 A						
•	•	3	0	PS1-3-0-100	1SAM 201 916 R1103	10 0.084
•	•	4	0	PS1-4-0-100	1SAM 201 916 R1104	10 0.117
•	•	5	0	PS1-5-0-100	1SAM 201 916 R1105	10 0.154
•	•	3	1	PS1-3-1-100	1SAM 201 916 R1113	10 0.094
•	•	4	1	PS1-4-1-100	1SAM 201 916 R1114	10 0.134
•	•	5	1	PS1-5-1-100	1SAM 201 916 R1115	10 0.172
•	•	3	2	PS1-3-2-100	1SAM 201 916 R1123	10 0.105

3-phase feeder terminals

Busbar types	Remarks	Rated cross section	Type	Order code	Pack ^(ing) pieces	Weight kg (1 pce)
65 A	100 A					
3-phase feeder terminals						
65 A	-	Flat	25 mm ²	S1-M1-25	1SAM 201 907 R1101	10 0.038
65 A	-	High	25 mm ²	S1-M2-25	1SAM 201 907 R1102	10 0.051
3-phase feeder terminals (suitable for UL type E and IEC)						
65 A	-		25 mm ²	S1-M3-25	1SAM 201 907 R1103	10 0.042
-	100 A		35 mm ²	S1-M3-35	1SAM 201 913 R1103	10 0.060

Cover for 3-phase busbars

	BS1-3	1SAM 201 908 R1001	50	0.003
--	-------	--------------------	----	-------

Locking

Manual Motor Starters	Type	Order code	Pack ^(ing) pieces	Weight kg (1 pce)	
MS116	MS132				
Locking device					
•	-	Lock adapter	SA1	GJF1 101 903 R0001	10 0.003
•	•	Padlock + 2 keys	SA2	GJF1 101 903 R0002	10 0.020
•	-	Lock adapter + padlock + 2 keys	SA3	GJF1 101 903 R0003	10 0.050

3-phase busbar up to 65 A

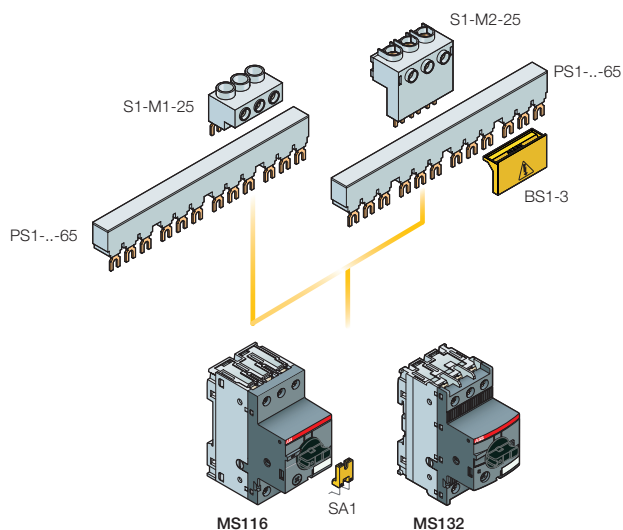

3-phase busbar up to 100 A

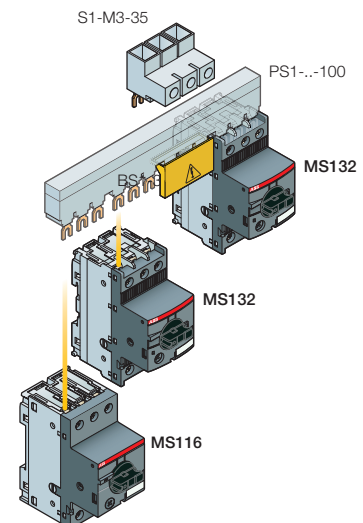

Main Accessories



IB132-Y



IB132-G



DMS132-Y



DMS132-G



Enclosures IP65

Padlockable max. 3 padlocks with bail diameter 4...6.5

Manual Motor Starters		Color	Type	Order code	Pack ^(ing) pieces	Weight kg (1 pce)
MS116	MS132	Yellow/red	IB132-Y	1SAM 201 911 R1011	1	0.370
•	•	Grey/black	IB132-G	1SAM 201 911 R1010	1	0.370

Indication I-O-T and ON-OFF-T

Door mounting kit IP65

Padlockable max. 3 padlocks with bail diameter 4...6.5

Manual Motor Starters		Color	Type	Order code	Pack ^(ing) pieces	Weight kg (1 pce)
MS116	MS132	Yellow/red	DMS132-Y	1SAM 201 912 R1011	1	0.170
•	•	Grey/black	DMS132-G	1SAM 201 912 R1010	1	0.170

Indication I-O-T and ON-OFF-T

Main Dimensions mm, inches

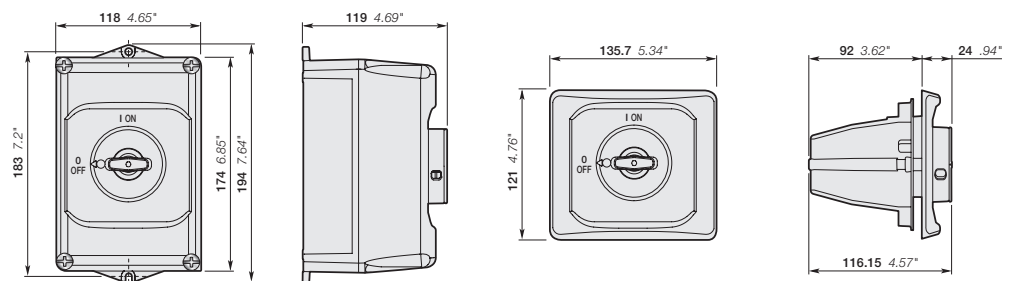

Main Accessories

Shafts

For selector type handles. Shaft diameter 6 mm. Shaft extension for door coupling driver.

Manual Motor Starters		Shaft length	Type	Order code	Pack ^(ing) pieces	Weight kg (1 pce)
MS116	MS132	mm				
•	•	85	OXS6X85	1SCA 101 647 R1001	1	0.020
•	•	105	OXS6X105	1SCA 108 043 R1001	1	0.020
•	•	130	OXS6X130	1SCA 101 655 R1001	1	0.030
•	•	180	OXS6X180	1SCA 101 659 R1001	1	0.040

Selector type handles IP64

Padlockable max. 3 padlocks with bail diameter 5...8, door interlock in ON position defeatable, for use with 6 mm OXS6... types up to 180 mm or driver shafts MSOX.

Manual Motor Starters		Color	Type	Order code	Pack ^(ing) pieces	Weight kg (1 pce)
MS116	MS132					
•	•	Black	MSHD-LB ⁽¹⁾	1SAM 201 920 R1001	1	0.065
•	•	Yellow	MSHD-LY ⁽¹⁾	1SAM 201 920 R1002	1	0.065
•	•	Black	MSHD-LTB ⁽²⁾	1SAM 201 920 R1011	1	0.065
•	•	Yellow	MSHD-LTY ⁽²⁾	1SAM 201 920 R1012	1	0.065

(1) Indication I-O and ON-OFF

(2) Indication I-O-T and ON-OFF-T

Driver

Coupling driver for use with 6 mm OXS6... types up to 180 mm.

Manual Motor Starters		Type	Order code	Pack ^(ing) pieces	Weight kg (1 pce)
MS116	MS132				
•	•	MSMN ⁽¹⁾	1SAM 101 923 R0002	1	0.002
•	•	MSMNO ⁽²⁾	1SAM 101 923 R0012	1	0.002

(1) Coded - Positioning of ON indication dependent from mounting orientation of the MS

(2) Uncoded - Positioning of ON indication independent from mounting orientation of the MS

Driver shafts

Driver shaft - combination driver & shaft. Shaft diameter 6 mm.

Manual Motor Starters		Shaft length	Type	Order code	Pack ^(ing) pieces	Weight kg (1 pce)
MS116	MS132	mm				
•	•	32	MSOX-32	1SAM 101 924 R0003	1	0.010
•	•	30	MSOX-30	1SAM 101 924 R0013	1	0.010



MSHD-LB



MSHD-LY



MSMN



MSOX-30

MS116 Manual Motor Starter

With Thermal and Electromagnetic Protection



Dimensions mm, inches

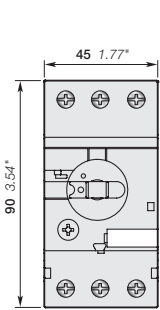

MS116

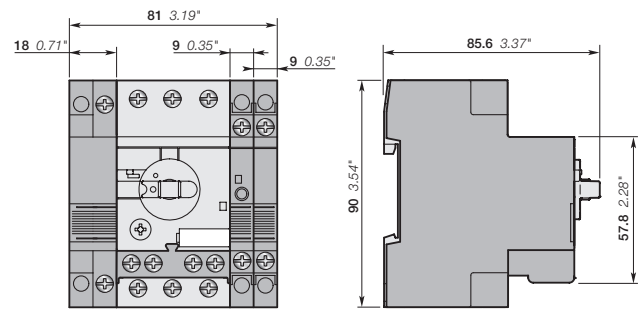
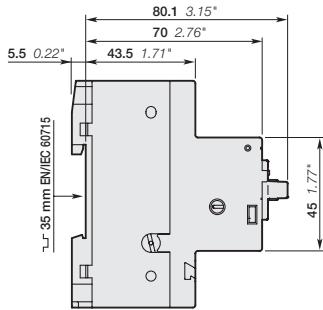

MS116
+ UA1, AA1, SK1, HK1, HKF1-11

MS132 Manual Motor Starter

With Thermal and Electromagnetic Protection



Dimensions mm, inches

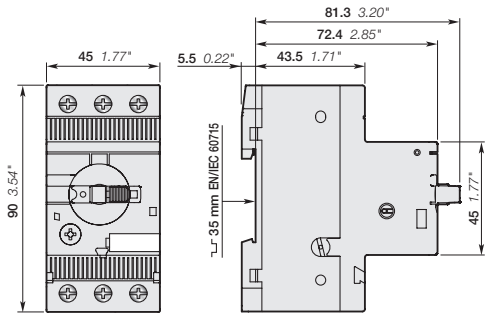

MS132-0.16 ... MS132-10

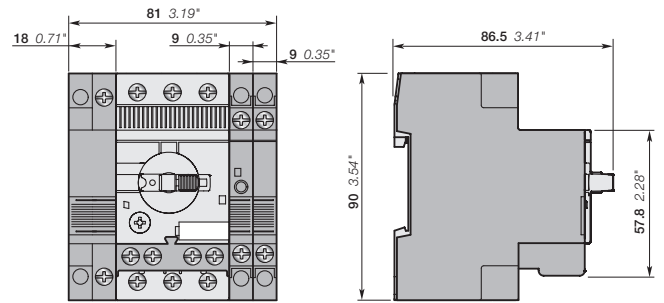

MS132-0.16 ... MS132-10
+ UA1, AA1, SK1, HK1, CK1, HKF1-11

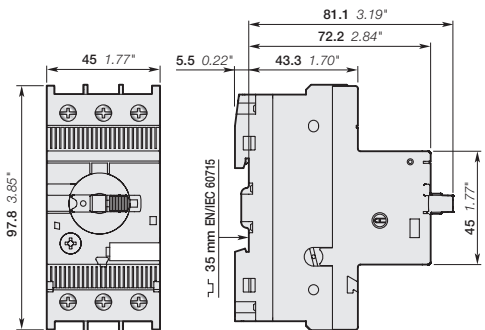

MS132-12 ... MS132-32

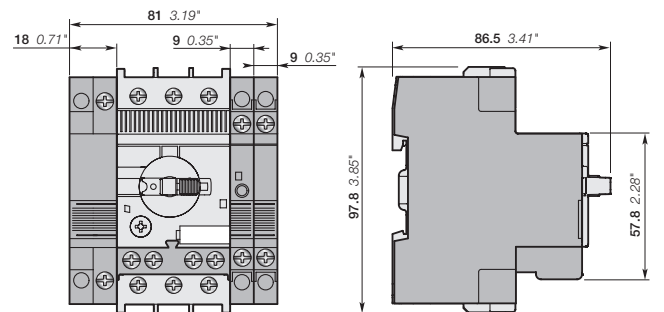

MS132-12 ... MS132-32
+ UA1, AA1, SK1, HK1, CK1, HKF1-11

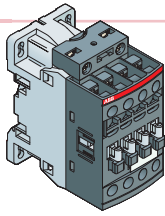

AF09 ... AF16
3-pole contactors

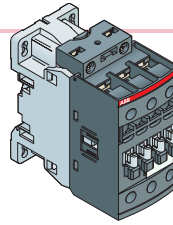

AF26 ... AF38
3-pole contactors

for Contactors

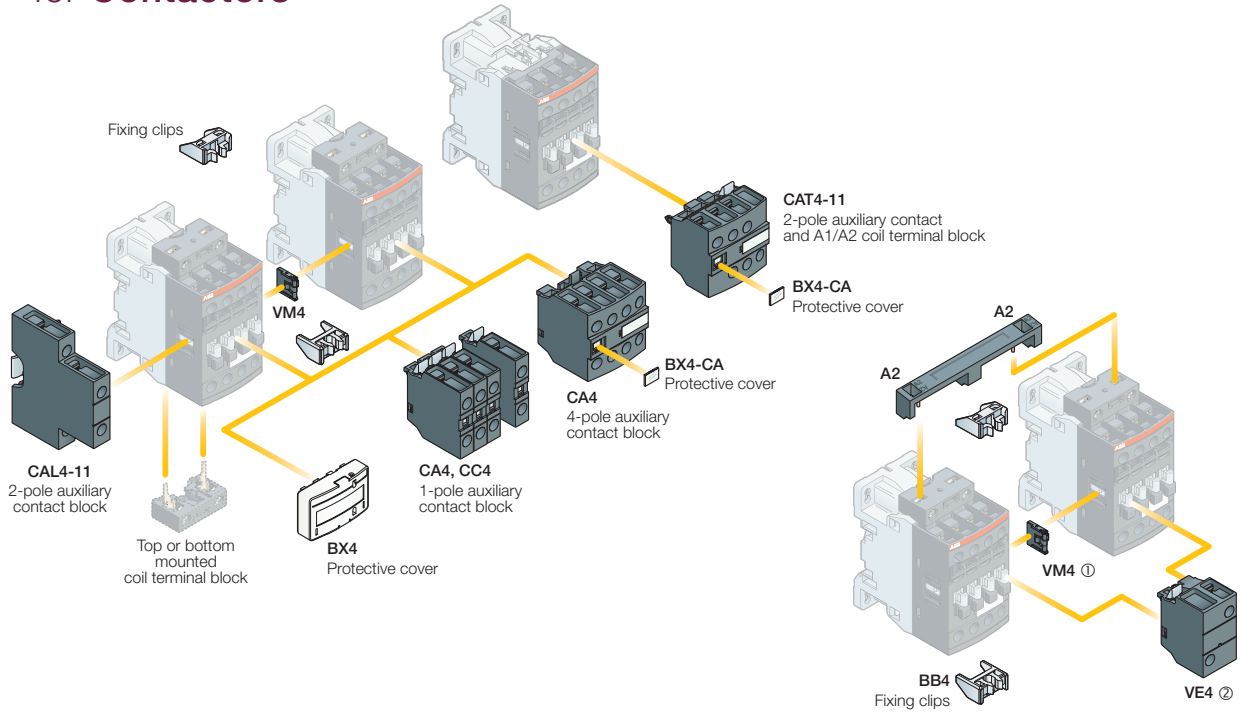

VEM4 mechanical and electrical interlock set including:
 ① VM4 mechanical interlock unit including 2 fixing clips (BB4)
 ② VE4 electrical interlock block with A2-A2 connection

for Starting Solutions

Direct-On-Line Starter

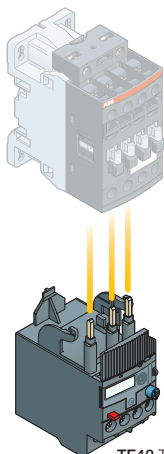

TF42 Thermal overload relay
EF.. Electronic overload relay

Reversing Starter

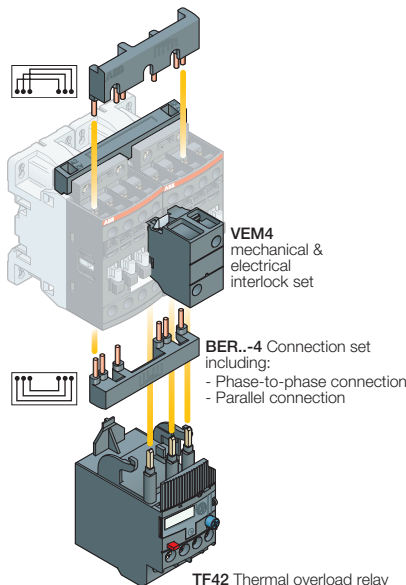

Star-Delta Starter

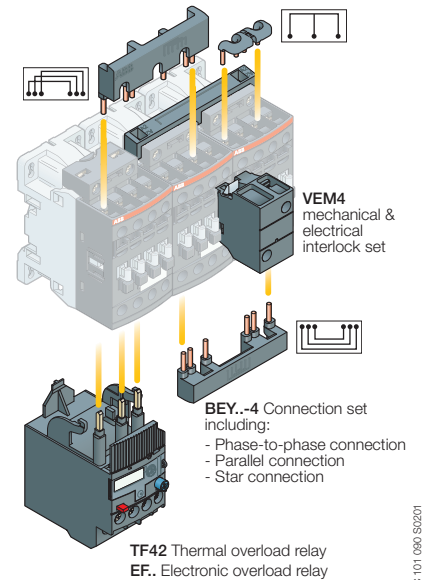

3-pole Contactors

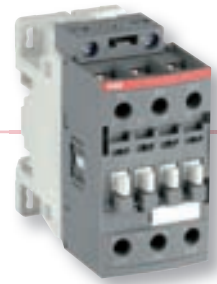

AC / DC control voltage

AF09	AF12	AF16
AF09-30-10	AF12-30-10	AF16-30-10
AF09-30-01	AF12-30-01	AF16-30-01

AF26	AF30	AF38
AF26-30-00	AF30-30-00	AF38-30-00

Switching of 3-phase Cage Motors

	IEC	AC-3	Rated power	400 V
			Rated operational current	$\theta \leq 60^\circ\text{C}$ 400 V $\theta \leq 60^\circ\text{C}$ 415 V $\theta \leq 60^\circ\text{C}$ 690 V
	UL/CSA	Motor rating	480 V	
		NEMA size		

4 kW	5.5 kW	7.5 kW
9 A	12 A	18 A
9 A	12 A	18 A
7 A	9 A	10.5 A
5 hp	7.5 hp	10 hp
00	0	-

11 kW	15 kW	18.5 kW
26 A	32 A	38 A
26 A	32 A	38 A
17 A	21 A	24 A
15 hp	20 hp	20 hp
1	-	-

Protection of 3-phase motors

Thermal overload relays



Electronic overload relays

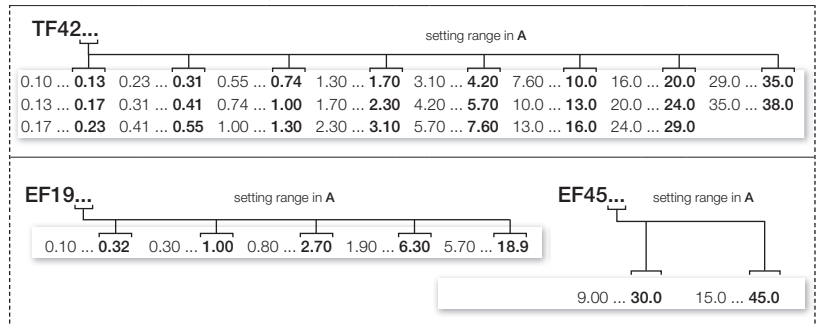
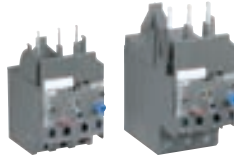

Switching of Resistive Circuits

	IEC	AC-1	Rated operational current	$\theta \leq 40^\circ\text{C}$ 690 V $\theta \leq 60^\circ\text{C}$ 690 V $\theta \leq 70^\circ\text{C}$ 690 V
			With conductor cross-sectional area	
	UL/CSA	General use rating	600 V AC	
		With conductor cross-sectional area		

25 A	28 A	30 A
25 A	28 A	30 A
22 A	24 A	26 A
4 mm ²	6 mm ²	6 mm ²
25 A	28 A	30 A
AWG 10	AWG 10	AWG 10

45 A	50 A	50 A
40 A	42 A	42 A
32 A	37 A	37 A
10 mm ²	10 mm ²	10 mm ²
45 A	50 A	50 A
AWG 8	AWG 8	AWG 8

Main Accessories

Auxiliary contact blocks	Front mounting	
	Side mounting	
Interlocks	Mechanical / electrical	
	Mechanical	
Connection sets	Reversing Starters	
	Star-Delta Starters	

1-pole CA4-10 or CA4-01, CC4-10 or CC4-01	
4-pole CA4	
2-pole CAT4-11 (with coil front connection)	
2-pole CAL4-11	
VEM4 including VM4 mechanical interlock unit and VE4 electrical interlock block with A2-A2 connection	
VM4 including 2 fixing clips	
BER16-4	BER38-4
BEY16-4	BEY38-4

1853C 101 000 5/2020

AF09 ... AF38 3-pole Contactors

AC / DC Operated - with Screw Terminals

Catalogue Page 1SBC 101 060 S0202



AF09-30-10



AF26-30-00

Application

AF09 ... AF38 contactors are used for controlling power circuits up to 690 V AC and 220 V DC. They are mainly used for controlling 3-phase motors, non-inductive or slightly inductive loads.

Description

- **AF09 ... AF38** contactors include an electronic coil interface accepting a wide control voltage U_c min. ... U_c max. Only four coils cover control voltages between 24...500 V 50/60 Hz or 20...500 V DC
- **AF** contactors can manage large control voltage variations. One coil (e.g. 100...250 V 50/60 Hz - DC) can be used for different control voltages used worldwide without any coil change
- **AF..Z** contactors equipped with a **Z** coil type allow direct control by 24 V DC 500 mA PLC-output and obtain a reduced holding coil consumption.
AF..Z contactors withstand short voltage dips and voltage sags (SEMI F47-0706 compliance)
- **AF** contactors have built-in surge protection and do not require additional surge suppressors
- The built-in N.C. auxiliary contact is a mirror contact in compliance with annex F of IEC 60947-4-1.

Ordering Details

IEC	UL/CSA	Control voltage		Auxiliary contacts fitted	Type	Order code	Weight		
		U_c min. ... U_c max.							
		V 50/60 Hz	V DC						
4	5	24...60	20...60	1 0	AF09Z-30-10-21	1SBL 136 001 R2110	0.310		
		24...60	20...60	0 1	AF09Z-30-01-21	1SBL 136 001 R2101	0.310		
		48...130	48...130	1 0	AF09-30-10-12	1SBL 137 001 R1210	0.270		
		48...130	48...130	0 1	AF09-30-01-12	1SBL 137 001 R1201	0.270		
		100...250	100...250	1 0	AF09-30-10-13	1SBL 137 001 R1310	0.270		
		100...250	100...250	0 1	AF09-30-01-13	1SBL 137 001 R1301	0.270		
		250...500	250...500	1 0	AF09-30-10-14	1SBL 137 001 R1410	0.310		
		250...500	250...500	0 1	AF09-30-01-14	1SBL 137 001 R1401	0.310		
		5.5	7.5	24...60	20...60	1 0	AF12Z-30-10-21	1SBL 156 001 R2110	0.310
				24...60	20...60	0 1	AF12Z-30-01-21	1SBL 156 001 R2101	0.310
				48...130	48...130	1 0	AF12-30-10-12	1SBL 157 001 R1210	0.270
				48...130	48...130	0 1	AF12-30-01-12	1SBL 157 001 R1201	0.270
				100...250	100...250	1 0	AF12-30-10-13	1SBL 157 001 R1310	0.270
				100...250	100...250	0 1	AF12-30-01-13	1SBL 157 001 R1301	0.270
250...500	250...500			1 0	AF12-30-10-14	1SBL 157 001 R1410	0.310		
250...500	250...500			0 1	AF12-30-01-14	1SBL 157 001 R1401	0.310		
7.5	10			24...60	20...60	1 0	AF16Z-30-10-21	1SBL 176 001 R2110	0.310
				24...60	20...60	0 1	AF16Z-30-01-21	1SBL 176 001 R2101	0.310
		48...130	48...130	1 0	AF16-30-10-12	1SBL 177 001 R1210	0.270		
		48...130	48...130	0 1	AF16-30-01-12	1SBL 177 001 R1201	0.270		
		100...250	100...250	1 0	AF16-30-10-13	1SBL 177 001 R1310	0.270		
		100...250	100...250	0 1	AF16-30-01-13	1SBL 177 001 R1301	0.270		
		250...500	250...500	1 0	AF16-30-10-14	1SBL 177 001 R1410	0.310		
		250...500	250...500	0 1	AF16-30-01-14	1SBL 177 001 R1401	0.310		
		11	15	24...60	20...60	0 0	AF26Z-30-00-21	1SBL 236 001 R2100	0.350
				48...130	48...130	0 0	AF26-30-00-12	1SBL 237 001 R1200	0.310
100...250	100...250			0 0	AF26-30-00-13	1SBL 237 001 R1300	0.310		
250...500	250...500			0 0	AF26-30-00-14	1SBL 237 001 R1400	0.350		
15	20			24...60	20...60	0 0	AF30Z-30-00-21	1SBL 276 001 R2100	0.350
		48...130	48...130	0 0	AF30-30-00-12	1SBL 277 001 R1200	0.310		
		100...250	100...250	0 0	AF30-30-00-13	1SBL 277 001 R1300	0.310		
		250...500	250...500	0 0	AF30-30-00-14	1SBL 277 001 R1400	0.350		
		18.5	20	24...60	20...60	0 0	AF38Z-30-00-21	1SBL 296 001 R2100	0.350
48...130	48...130			0 0	AF38-30-00-12	1SBL 297 001 R1200	0.310		
100...250	100...250			0 0	AF38-30-00-13	1SBL 297 001 R1300	0.310		
250...500	250...500			0 0	AF38-30-00-14	1SBL 297 001 R1400	0.350		

Main Dimensions mm, inches

AF09, AF12, AF16

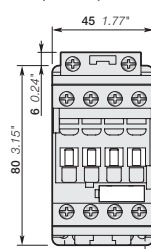

AF26, AF30, AF38

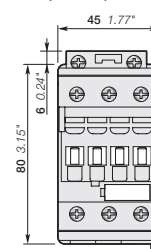

AF09 ... AF38 3-pole Contactors

AC / DC Operated - with Screw Terminals

Catalogue Page 1SBC 101 063 S0201



4 to 18.5 kW
5 to 20 hp

Main Technical Data

Contactor types		AF09	AF12	AF16	AF26	AF30	AF38	
Standards		IEC 60947-1 / 60947-4-1 and EN 60947-1 / 60947-4-1, UL 508, CSA C22.2 N°14						
Main poles	Rated operational voltage U_o max.	690 V						
	Rated frequency limits	25 ... 400 Hz						
IEC	AC-3 Utilization category for air temperature close to contactor $\theta \leq 60^\circ\text{C}$ (for 1500 r.p.m., 50 Hz or 1800 r.p.m., 60 Hz, 3-phase motors)							
	I_o / AC-3 max. rated operational current	380-400 V	9 A	12 A	18 A	26 A	32 A	38 A
	AC-3 rated operational power	220-230-240 V	2.2 kW	3 kW	4 kW	6.5 kW	9 kW	11 kW
		380-400 V	4 kW	5.5 kW	7.5 kW	11 kW	15 kW	18.5 kW
		415 V	4 kW	5.5 kW	9 kW	11 kW	15 kW	18.5 kW
		440 V	4 kW	5.5 kW	9 kW	15 kW	18.5 kW	22 kW
		500 V	5.5 kW	7.5 kW	9 kW	15 kW	18.5 kW	22 kW
		690 V	5.5 kW	7.5 kW	9 kW	15 kW	18.5 kW	22 kW
	I_o / AC-1 rated operational current	$\theta \leq 40^\circ\text{C}$	25 A	28 A	30 A	45 A	50 A	50 A
	U_o max. $\leq 690\text{ V}, 50/60\text{ Hz}$	$\theta \leq 60^\circ\text{C}$	25 A	28 A	30 A	40 A	42 A	42 A
	$\theta \leq 70^\circ\text{C}$	22 A	24 A	26 A	32 A	37 A	37 A	
with conductor cross-sectional area		4 mm ²	6 mm ²	6 mm ²	10 mm ²	10 mm ²	10 mm ²	
I_o / AC-8a rated operational current (without thermal overload relay - U_o 400 V - $\theta \leq 40^\circ\text{C}$)		12 A	16 A	22 A	30 A	40 A	50 A	
UL/CSA	Rated operational voltage U_o max.	600 V						
	3-phase motor power (for 1500 r.p.m., 50 Hz or 1800 r.p.m., 60 Hz 3-phase motors)	440-480 V	5 hp	7.5 hp	10 hp	15 hp	20 hp	20 hp
	General use Amp rating with conductor cross-sectional area	600 V AC	25 A AWG 10	28 A AWG 10	30 A AWG 10	45 A AWG 8	50 A AWG 8	50 A AWG 8
Ambient air temperature close to contactor	Operation - fitted with thermal overload relay	-25 ... +60 °C						
	Storage - without thermal overload relay	-40 ... +70 °C						
Magnet system	Coil operating limits (acc. to IEC 60947-4-1)	AC supply	at $\theta \leq 60^\circ\text{C}$ $0.85 \times U_c$ min ... $1.1 \times U_c$ max at $\theta \leq 70^\circ\text{C}$ $0.85 \times U_c$ min ... U_c max					
		DC supply	at $\theta \leq 60^\circ\text{C}$ $0.85 \times U_c$ min ... $1.1 \times U_c$ max at $\theta \leq 70^\circ\text{C}$ (AF) $0.85 \times U_c$ min ... U_c max - (AF.Z) $0.85 \times U_c$ min ... $1.1 \times U_c$ max					
AC control voltage 50/60 Hz	Rated control circuit voltage U_c	24 ... 500 V AC						
	Coil consumption	Average pull-in value	(AF) 50 VA - (AF.Z) 16 VA					
		Average holding value	(AF) 2.2 VA / 2 W - (AF.Z) 1.7 VA / 1.5 W					
DC control voltage	Rated control circuit voltage U_c	20 ... 500 V DC						
	PLC-output control	(AF.Z) $\geq 500\text{ mA}$ 24 V DC						
	Coil consumption	Average pull-in value	(AF) 50 W - (AF.Z) 12 ... 16 W					
	Average holding value	(AF) 2 W - (AF.Z) 1.7 W						
Electromagnetic compatibility		Devices complying with IEC 60947-1 / EN 60947-1 - Environment A						
Built-in auxiliary contacts								
IEC acc. to IEC 60947-5-1	Rated operational voltage U_o max.	690 V						
	I_o / AC-15 rated operational current	400-440 V	3 A					
	I_o / DC-13 rated operational current	24 V DC	6 A / 144 W					
UL/CSA	Pilot duty	A600, Q600						
Connecting capacity	Main pole terminals	Rigid	1 or 2 x	1 ... 6 mm ²		2.5 ... 10 mm ²		
		Flexible with ferrule	1 or 2 x	0.75 ... 6 mm ²		1.5 ... 10 mm ²		
		Capacity acc. to UL/CSA	1 or 2 x	AWG 16 ... 10		AWG 14 ... 8		
		Tightening torque		1.5 Nm / 13 lb.in		2.5 Nm / 22 lb.in		
		Stripping length		10 mm		14 mm		
	Coil or built-in auxiliary contact terminals	Rigid	1 or 2 x	1 ... 2.5 mm ²				
		Flexible with ferrule	1 or 2 x	0.75 ... 2.5 mm ²				
		Capacity acc. to UL/CSA	1 or 2 x	AWG 18 ... 14				
		Tightening torque		1.2 Nm / 11 lb.in				
		Stripping length		10 mm				
Degree of protection	acc. to IEC 60947-1 / EN 60947-1 and IEC 60529 / EN 60529	IP20						

AF09 ... AF38 3-pole Contactors

Main Accessories



Accessory fitting details for a 3-pole contactor AF09 ... AF38

Many configurations of accessories are possible depending on whether these are front-mounted or side-mounted.

Contactor types	Main poles	Built-in auxiliary contacts	Front-mounted accessories				Side-mounted accessories	
			Auxiliary contact blocks			Electrical and mechanical interlock set (between 2 contactors)	Auxiliary contact blocks	
			1-pole CA4	2-pole CAT4-11	4-pole CA4	VEM4	Left side 2-pole CAL4-11	Right side
			Max. N.C. built-in and add-on N.C. auxiliary contacts: 4 N.C. max. on positions 1, 2, 3, 4 and 3 N.C. max. on positions 1 ±30°, 5					
AF09 ... AF16	3	0 0 1	4 max.	or 1	or 1	-	+ 1	-
			2 max.	-	-	-	+ 1	+ 1
			3 max.	-	-	+ 1	+ 1	or 1
AF09 ... AF16	3	0 1 0	4 max.	or 1	or 1	-	+ 1	-
			2 max.	or 1	-	-	+ 1	+ 1
AF26 ... AF38	3	0 0 0	4 max.	or 1	-	-	+ 1	+ 1
			3 max.	-	-	+ 1	+ 1	or 1

Mounting positions



Protection against overloads with thermal or electronic overload relays

The addition of an overload relay on the contactor does not prevent fitting of many other accessories as shown below.

Contactor types	Overload relays - direct mounting - no kit required
AF09 ... AF38	TF42 thermal overload relay
AF09 ... AF38	EF19 electronic overload relay
AF26 ... AF38	EF45 electronic overload relay

Contactors and main accessories (other accessories available)

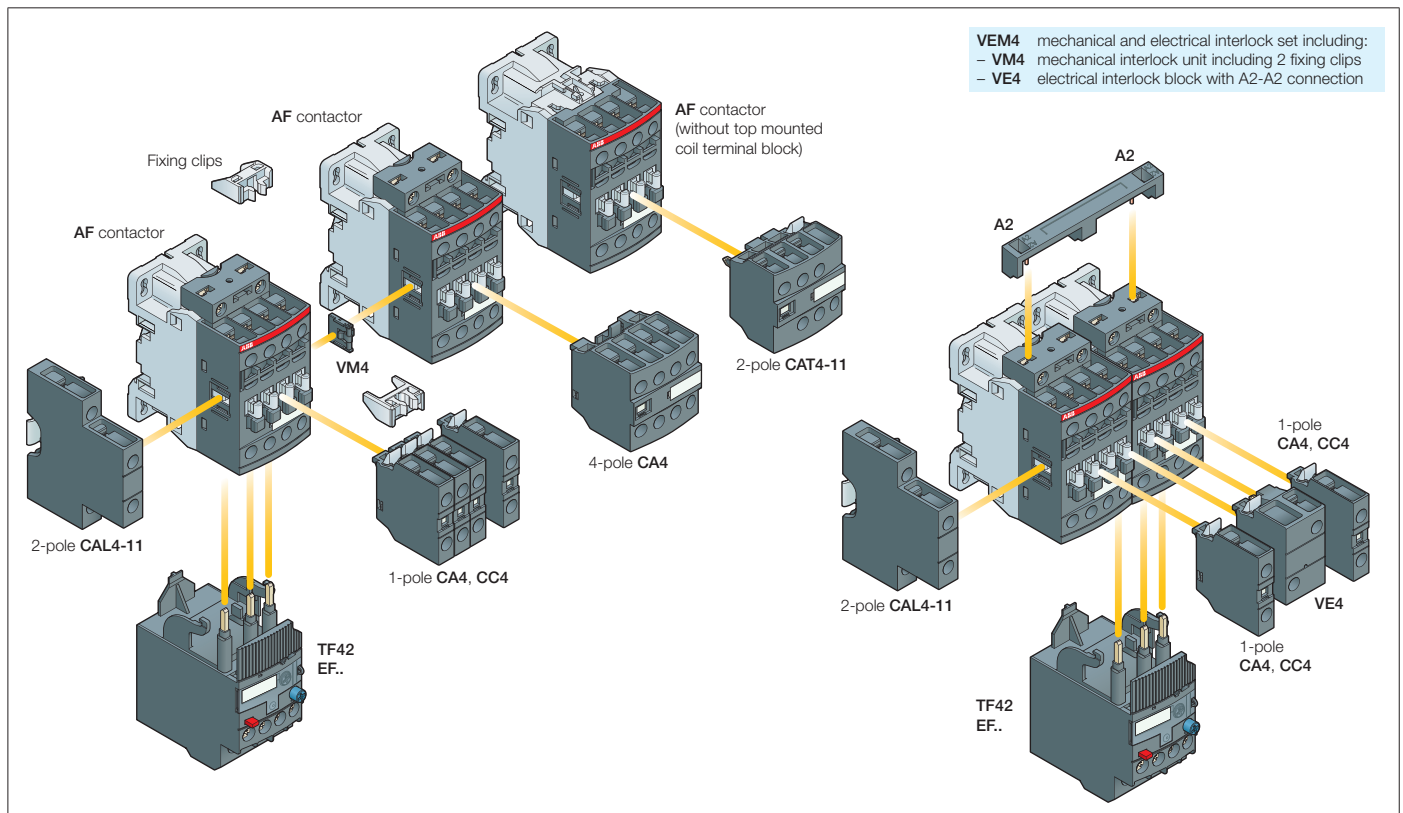

AF09 ... AF38 3-pole Contactors

Main Accessories

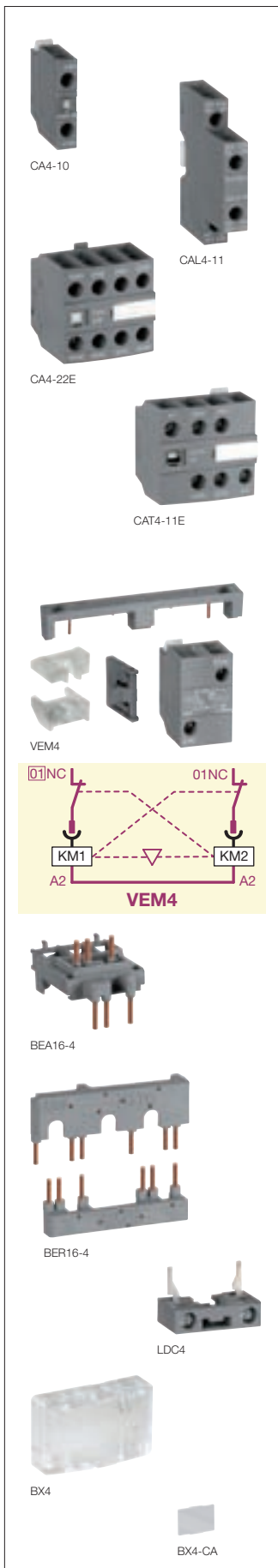

Ordering Details

For contactors	Auxiliary contacts	Type	Order code	Pack ^(ing) pieces	Weight kg (1 poe)

Additional auxiliary contact blocks

Front-mounted instantaneous auxiliary contact blocks

AF09 ... AF38	1 0 - -	CA4-10	1SBN 010 110 R1010	1	0.014
	1 0 - -	CA4-10-T	1SBN 010 110 T1010	10	0.014
	0 1 - -	CA4-01	1SBN 010 110 R1001	1	0.014
	0 1 - -	CA4-01-T	1SBN 010 110 T1001	10	0.014
AF09 ... AF16...-30-10	2 2 - -	CA4-22M	1SBN 010 140 R1122	1	0.055
	3 1 - -	CA4-31M	1SBN 010 140 R1131	1	0.055
	1 3 - -	CA4-13M	1SBN 010 140 R1113	1	0.055
	0 4 - -	CA4-04M	1SBN 010 140 R1104	1	0.055
	AF26 ... AF38...-30-00	2 2 - -	CA4-22E	1SBN 010 140 R1022	1
3 1 - -		CA4-31E	1SBN 010 140 R1031	1	0.055
4 0 - -		CA4-40E	1SBN 010 140 R1040	1	0.055
0 4 - -		CA4-04E	1SBN 010 140 R1004	1	0.055
AF09 ... AF16...-30-01	4 0 - -	CA4-40U	1SBN 010 140 R1340	1	0.055
	3 1 - -	CA4-31U	1SBN 010 140 R1331	1	0.055
	2 2 - -	CA4-22U	1SBN 010 140 R1322	1	0.055

Front-mounted auxiliary contact blocks with N.O. leading contact and N.C. lagging contact

AF09 ... AF38	- - 1 0	CC4-10	1SBN 010 111 R1010	1	0.014
	- - 0 1	CC4-01	1SBN 010 111 R1001	1	0.014

Side-mounted instantaneous auxiliary contact blocks

AF09 ... AF38	1 1 - -	CAL4-11	1SBN 010 120 R1011	1	0.040
	1 1 - -	CAL4-11-T	1SBN 010 120 T1011	10	0.040

Front-mounted instantaneous auxiliary contact and A1/A2 coil terminal blocks

AF09 ... AF16...-30-10	1 1 - -	CAT4-11M	1SBN 010 151 R1111	1	0.040
AF26 ... AF38...-30-00	1 1 - -	CAT4-11E	1SBN 010 151 R1011	1	0.040
AF09 ... AF16...-30-01	1 1 - -	CAT4-11U	1SBN 010 151 R1311	1	0.040

Interlocks

Mechanical interlock unit

AF09 ... AF38		VM4	1SBN 030 105 T1000	10	0.005
---------------	--	-----	--------------------	----	-------

Note: VM4 includes 2 fixing clips (BB4) to maintain together both contactors.

Mechanical and electrical interlock set

AF09 ... AF16	1 1 - -	VEM4	1SBN 030 111 R1000	1	0.035
AF26 ... AF38					

Note: VEM4 includes a VM4 mechanical interlock unit with 2 fixing clips (BB4), a VE4 electrical interlock block. VE4 block must be used with A2-A2 connection to respect the electrical connection diagram.

Fixing clips

AF09 ... AF38		BB4	1SBN 110 120 W1000	50	0.002
---------------	--	-----	--------------------	----	-------

Connection accessories for starting

Connecting links with manual motor starters

AF09 ... AF16 with MS116 and MS132		BEA16-4	1SBN 081 306 T1000	10	0.025
AF26 ... AF38 with MS116 and MS132-0.16 ... MS132-10		BEA26-4	1SBN 082 306 T1000	10	0.025
AF26 ... AF38 with MS132-12 ... MS132-32		BEA38-4	1SBN 082 306 T2000	10	0.030

Connection sets for reversing contactors

AF09 ... AF16		BER16-4	1SBN 081 311 R1000	1	0.045
AF26 ... AF38		BER38-4	1SBN 082 311 R1000	1	0.100

Connection sets for Star-Delta starting

AF09 ... AF16		BEY16-4	1SBN 081 313 R2000	1	0.050
AF26 ... AF38		BEY38-4	1SBN 082 713 R2000	1	0.110

Additional coil terminal block

AF09 ... AF38		LDC4	1SBN 070 156 T1000	10	0.010
---------------	--	------	--------------------	----	-------

Protective covers

All 1-stack contactors		BX4	1SBN 110 108 T1000	10	0.006
For 4-pole CA4 and 2-pole CAT4 auxiliary contact blocks		BX4-CA	1SBN 110 109 W1000	50	0.001

AF09 ... AF16 3-pole Contactors

AC / DC Operated - with Screw Terminals



Dimensions mm, inches

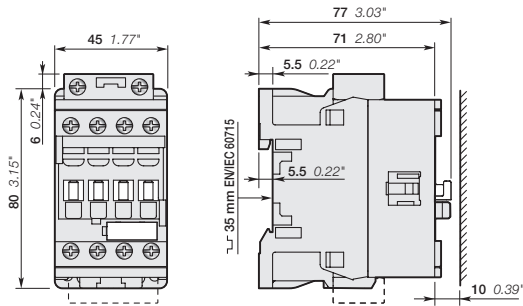

AF09, AF12, AF16

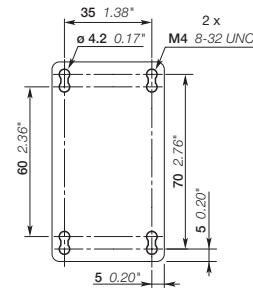

AF09, AF12, AF16

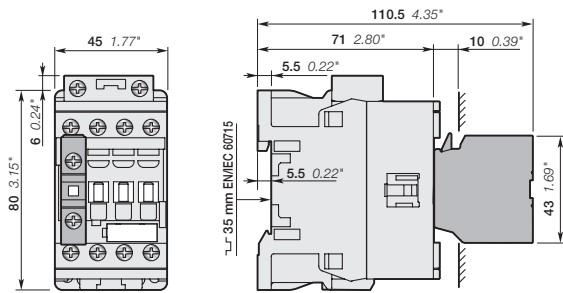

AF09, AF12, AF16
+ CA4, CC4 1-pole auxiliary contact block

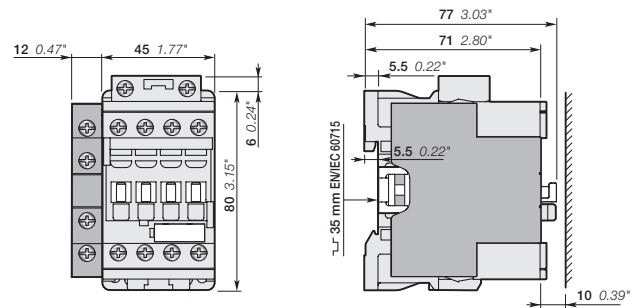

AF09, AF12, AF16
+ CAL4-11 2-pole auxiliary contact block

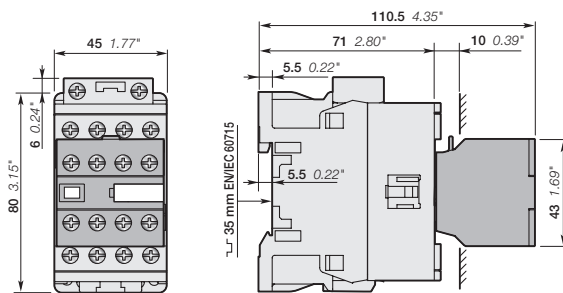

AF09, AF12, AF16
+ CA4 4-pole auxiliary contact block

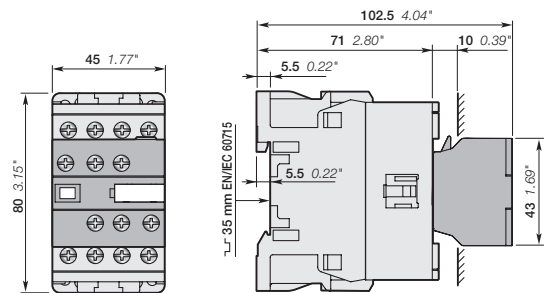

AF09, AF12, AF16
+ CAT4 2-pole auxiliary contact and coil terminal block

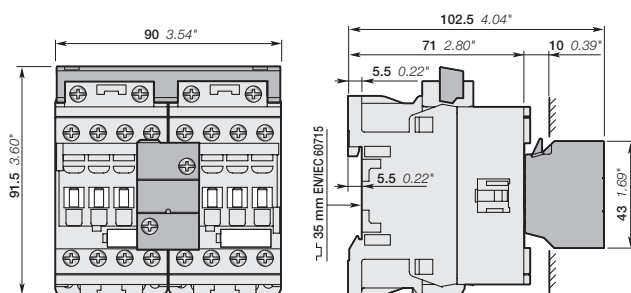

AF09, AF12, AF16
+ VEM4 mechanical and electrical interlock set

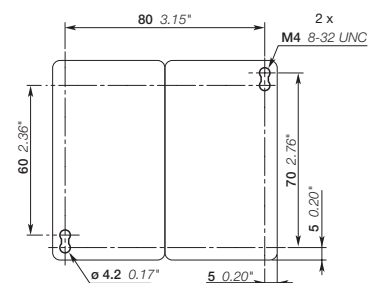

AF09, AF12, AF16
+ VEM4 mechanical and electrical interlock set

Note: contactor lateral distance to grounded component 2 mm 0.08" min.

AF26 ... AF38 3-pole Contactors

AC / DC Operated - with Screw Terminals



Dimensions mm, inches

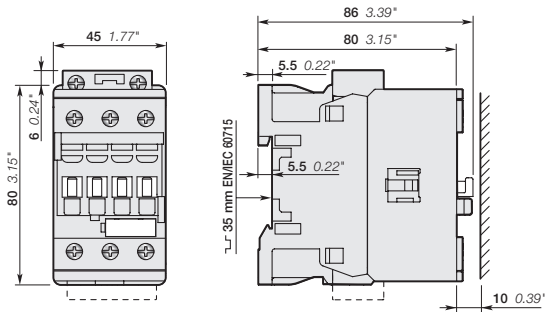

AF26, AF30, AF38

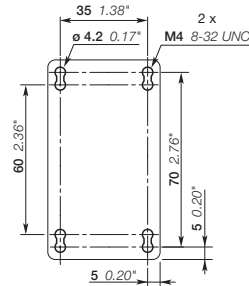

AF26, AF30, AF38

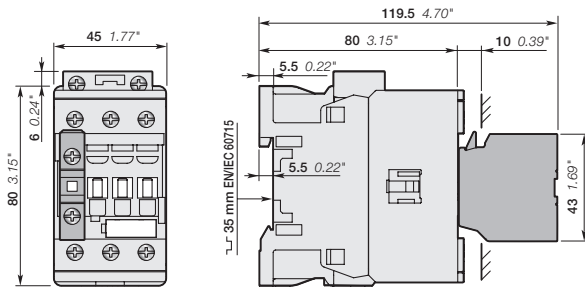

AF26, AF30, AF38
+ CA4, CC4 1-pole auxiliary contact block

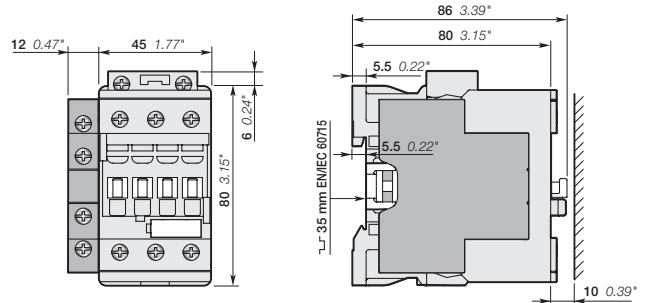

AF26, AF30, AF38
+ CAL4-11 2-pole auxiliary contact block

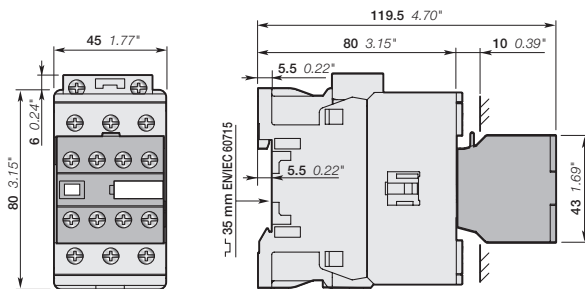

AF26, AF30, AF38
+ CA4 4-pole auxiliary contact block

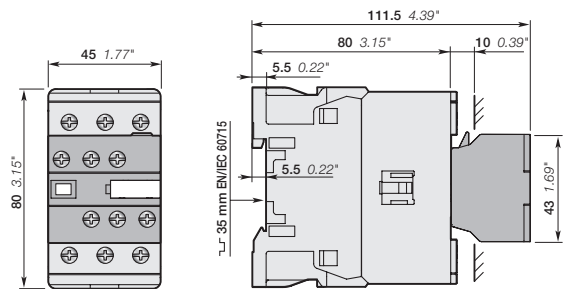

AF26, AF30, AF38
+ CAT4 2-pole auxiliary contact and coil terminal block

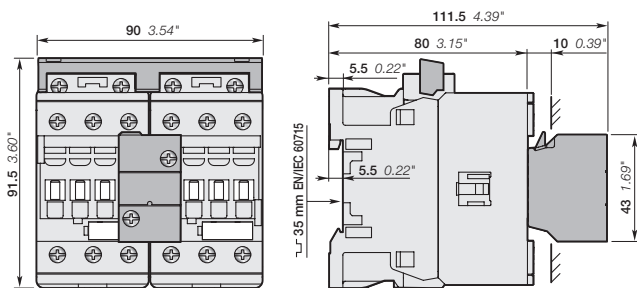

AF26, AF30, AF38
+ VEM4 mechanical and electrical interlock set

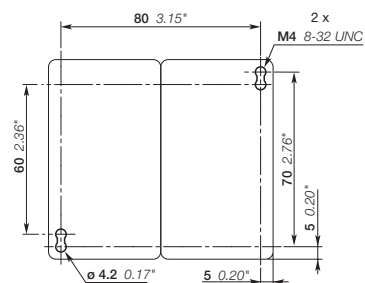

AF26, AF30, AF38
+ VEM4 mechanical and electrical interlock set

Note: contactor lateral distance to grounded component 2 mm 0.08" min.

0.10 ... 38.0 A
Class 10

TF42

Application

- Overload protection
- Trip class 10
- Phase loss sensitivity
- Manual/automatic reset selectable

Description

- 45 mm width
- Suitable for contactor **AF09 ... AF38**
- Sealable operating elements

Ordering Details





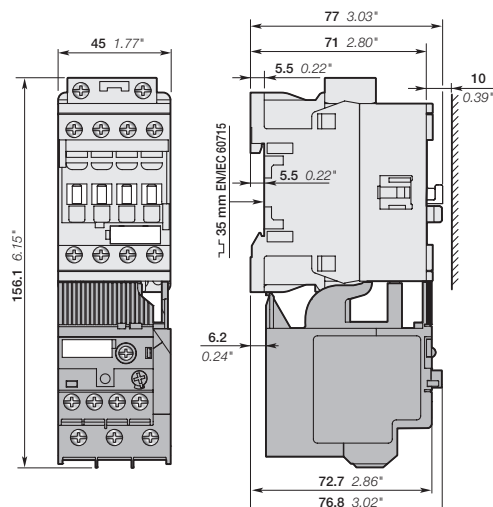
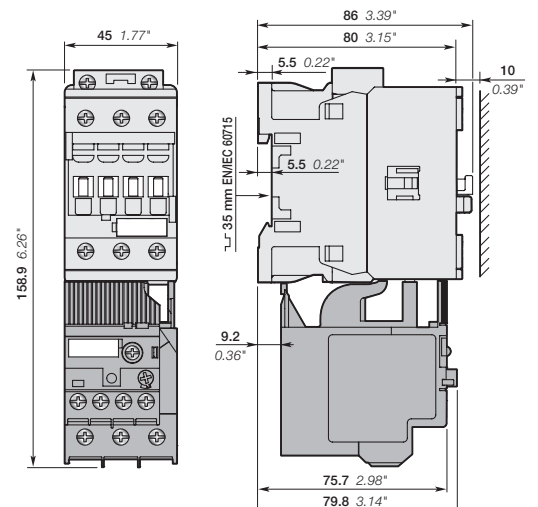





Setting ranges	Type	Order code	Max. fuse	Suitable for contactors	Pack ^(ing) pieces	Weight kg (1 pce)
A ... A			A			kg (1 pce)
0.10 ... 0.13	TF42-0.13	1SAZ 721 201 R1005	0.5 T	AF09 ... AF38	1	0.130
0.13 ... 0.17	TF42-0.17	1SAZ 721 201 R1008	1 T	AF09 ... AF38	1	0.130
0.17 ... 0.23	TF42-0.23	1SAZ 721 201 R1009	1 T	AF09 ... AF38	1	0.130
0.23 ... 0.31	TF42-0.31	1SAZ 721 201 R1013	1 T	AF09 ... AF38	1	0.130
0.31 ... 0.41	TF42-0.41	1SAZ 721 201 R1014	2 gG	AF09 ... AF38	1	0.130
0.41 ... 0.55	TF42-0.55	1SAZ 721 201 R1017	2 gG	AF09 ... AF38	1	0.130
0.55 ... 0.74	TF42-0.74	1SAZ 721 201 R1021	4 gG	AF09 ... AF38	1	0.130
0.74 ... 1.00	TF42-1.0	1SAZ 721 201 R1023	6 gG	AF09 ... AF38	1	0.130
1.00 ... 1.30	TF42-1.3	1SAZ 721 201 R1025	6 gG	AF09 ... AF38	1	0.130
1.30 ... 1.70	TF42-1.7	1SAZ 721 201 R1028	10 gG	AF09 ... AF38	1	0.130
1.70 ... 2.30	TF42-2.3	1SAZ 721 201 R1031	10 gG	AF09 ... AF38	1	0.130
2.30 ... 3.10	TF42-3.1	1SAZ 721 201 R1033	10 gG	AF09 ... AF38	1	0.130
3.10 ... 4.20	TF42-4.2	1SAZ 721 201 R1035	20 gG	AF09 ... AF38	1	0.130
4.20 ... 5.70	TF42-5.7	1SAZ 721 201 R1038	20 gG	AF09 ... AF38	1	0.130
5.70 ... 7.60	TF42-7.6	1SAZ 721 201 R1040	35 gG	AF09 ... AF38	1	0.130
7.60 ... 10.0	TF42-10	1SAZ 721 201 R1043	35 gG	AF09 ... AF38	1	0.130
10.0 ... 13.0	TF42-13	1SAZ 721 201 R1045	40 gG	AF09 ... AF38	1	0.130
13.0 ... 16.0	TF42-16	1SAZ 721 201 R1047	40 gG	AF09 ... AF38	1	0.130
16.0 ... 20.0	TF42-20	1SAZ 721 201 R1049	63 gG	AF09 ... AF38	1	0.130
20.0 ... 24.0	TF42-24	1SAZ 721 201 R1051	63 gG	AF09 ... AF38	1	0.145
24.0 ... 29.0	TF42-29	1SAZ 721 201 R1052	63 gG	AF09 ... AF38	1	0.145
29.0 ... 35.0	TF42-35	1SAZ 721 201 R1053	80 gG	AF09 ... AF38	1	0.145
35.0 ... 38.0/40.0	TF42-38	1SAZ 721 201 R1055	80 gG	AF09 ... AF38	1	0.145

Main Dimensions (mm, inches)

 AF09, AF12, AF16 3-pole contactors
 + TF42 thermal overload relay

 AF26, AF30, AF38 3-pole contactors
 + TF42 thermal overload relay

	0.10 ... 38.0 A
	Class 10

Main Technical Data

Overload Relay Type		TF42	
		up to 20.0 A	up to 38.0/40.0 A
Standards	Conformity to standards	IEC/EN60947-1, IEC/EN60947-4-1, IEC/EN60947-5-1, UL 508, CSA C22.2 No. 14	
	Phase loss sensitivity (acc. to IEC/EN 60947-4-1)	Yes	
General data	Mounting position	Position 1	
	Degree of protection (acc. to IEC 60947-1)	IP 20	
IEC			
Main circuit	Rated operational voltage U_e	690 V AC	
	Rated operational current AC-3 I_e	up to 20.0 A	up to 38.0/40.0 A (50 °C)
	Rated frequency	50 / 60 Hz	
	Trip class	10	
Isolation data	Rated impulse withstand voltage U_{imp}	6 kV	
(acc. to IEC/EN 60947-1)	Rated insulation voltage U_i	690 V	
Environmental data	Ambient air temperature range		
	Operation	Open - compensated	-25 ... +60 °C
		Open	-25 ... +60 °C
	Storage		-50 ... +80 °C
	Altitude		≤ 2000 m
	Vibration (acc. to IEC/EN 60068-2-6)		5 g / 3-150 Hz
	Shock (acc. to IEC/EN 60068-2-27)		25 g / 11 ms
Auxiliary circuit	Rated operational voltage U_e (acc. to IEC/EN 60947-5-1)	600 V	
	Rated operational current I_e (acc. to IEC/EN 60947-5-1 utilization category)		
	AC-15	110-120 V	N.C. 3 A N.O. 0.75 A
		220-230-240 V	N.C. 3 A N.O. 0.75 A
		400 V	N.C. 0.75 A N.O. 0.75 A
		480-500 V	N.C. 0.75 A N.O. 0.75 A
		600 V	N.C. 0.6 A N.O. -
	DC-13	24 V	N.C. 1.25 A N.O. 1.25 A
		110-120-125 V	N.C. 0.55 A N.O. 0.55 A
		250 V	N.C. 0.27 A N.O. 0.27 A
		500 V	N.C. 0.15 A N.O. 0.15 A
	Minimum switching capacity		17 V / 3 mA
	Short-circuit protection device		N.C. 6 N.O. 4
Connecting capacity	Main circuit	 Rigid	1 or 2 x 0.75 ... 4 mm ² 1.5 ... 2.5 mm ² - 2.5 ... 10 mm ²
		 Flexible with ferrule	1 or 2 x 0.75 ... 4 mm ² 1.5 ... 6 mm ²
		 Flexible without ferrule	1 or 2 x 0.75 ... 4 mm ² 2.5 ... 4 mm ² - 4 ... 6 mm ²
		Stripping length	12 mm
		Tightening torque	1.5 ... 2.5 Nm 2.5 ... 2.7 Nm
	Auxiliary circuit	 Rigid	1 or 2 x 0.75 ... 4 mm ²
		 Flexible with ferrule	1 or 2 x 0.75 ... 2.5 mm ²
		 Flexible without ferrule	1 or 2 x 0.75 ... 1 mm ² - 1 ... 2.5 mm ²
		Stripping length	9 mm
		Tightening torque	1.0 ... 1.5 Nm
UL/CSA			
Main circuit	Max. operational voltage	600 V AC	
	Trip rating	125 % of FLA	
Connecting capacity	Main circuit	 Stranded	1 or 2 x AWG 18 ... 10 AWG 14 ... 6
		 Flexible without ferrule	1 or 2 x AWG 18 ... 10 AWG 14 ... 6
		Stripping length	12 mm
		Tightening torque	13 ... 22 lb.in 22 lb.in
	Auxiliary circuit	 Stranded	1 or 2 x AWG 18 ... 12
		 Flexible without ferrule	1 or 2 x AWG 18 ... 12
		Stripping length	9 mm
		Tightening torque	9 ... 13 lb.in



0.10 ... 45.0 A
Class 10E, 20E, 30E



EF19



EF45

Application

- Overload protection
- Trip class 10E, 20E, 30E
- Phase loss sensitivity
- Manual/automatic reset selectable

Description

- 45 mm width
- Suitable for contactor **AF09 ... AF38**

Ordering Details

Setting ranges	Type	Order code	Max. fuse gG A	Suitable for contactors	Pack ^(mg) pieces	Weight kg (1 pce)
A ... A						

EF19 Electronic Overload Relay

0.10 ... 0.32	EF19-0.32	1SAX 121 001 R1101	1	AF09 ... AF26	1	0.158
0.30 ... 1.00	EF19-1.0	1SAX 121 001 R1102	4	AF09 ... AF26	1	0.158
0.80 ... 2.70	EF19-2.7	1SAX 121 001 R1103	10	AF09 ... AF26	1	0.158
1.90 ... 6.30	EF19-6.3	1SAX 121 001 R1104	20	AF09 ... AF26	1	0.158
5.70 ... 18.9	EF19-18.9	1SAX 121 001 R1105	50	AF09 ... AF26	1	0.158

EF45 Electronic Overload Relay

9.00 ... 30.0	EF45-30	1SAX 221 001 R1101	160	AF26 ... AF38	1	0.362
15.0 ... 45.0	EF45-45	1SAX 221 001 R1102	160	AF26 ... AF38	1	0.362

Main Dimensions mm, inches

AF09, AF12, AF16 3-pole contactors
+ EF19 electronic overload relay

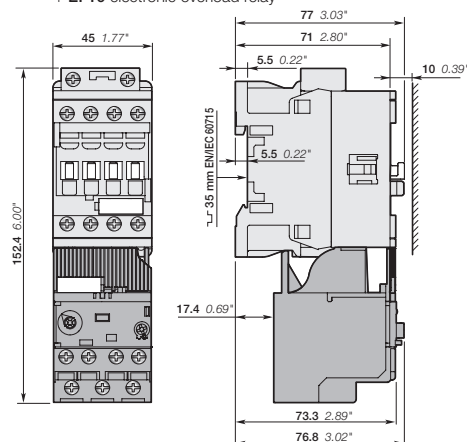

AF26 3-pole contactors
+ EF19 electronic overload relay

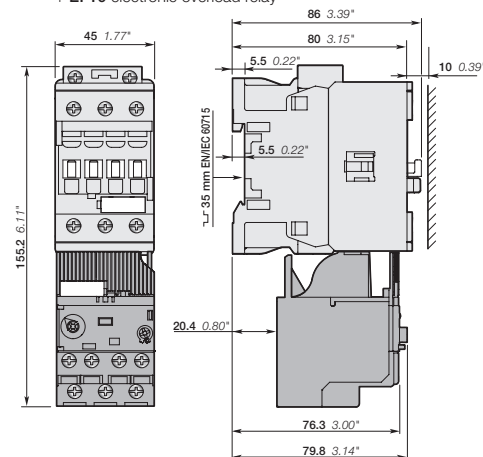

AF26, AF30, AF38 3-pole contactors
+ EF45 electronic overload relay

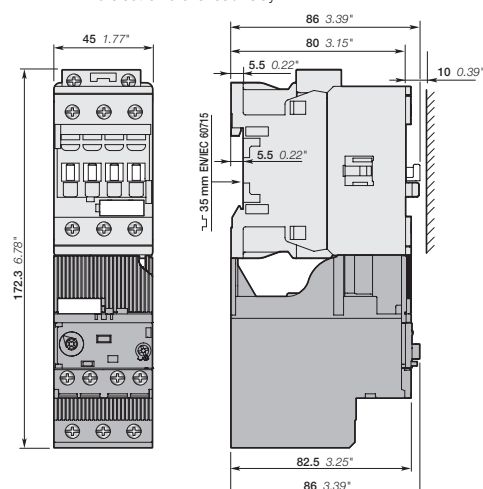

EF19 and EF45 Electronic Overload Relays

Catalogue Page 1SBC 101 096 S0201



0.10 ... 45.0 A
Class 10E, 20E, 30E

Main Technical Data

Overload Relay Types		EF19	EF45		
		up to 18.9 A	up to 45.0 A		
Standards	Conformity to standards	IEC/EN60947-1, IEC/EN60947-4-1, IEC/EN60947-5-1, UL 508, CSA C22.2 No. 14			
	Phase loss sensitivity (acc. to IEC/EN 60947-4-1)	Yes			
General data	Mounting position	any			
	Degree of protection (acc. to IEC 60947-1)	IP 20			
IEC					
Main circuit	Rated operational voltage U_o	690 V AC			
	Rated operational current AC-3 I_o	up to 18.9 A	up to 45.0 A		
	Rated frequency	50 / 60 Hz			
	Trip class	10E, 20E, 30E			
Isolation data (acc. to IEC/EN 60947-1)	Rated impulse withstand voltage U_{imp}	6 kV			
	Rated insulation voltage U_i	690 V			
Environmental data	Ambient air temperature range				
	Operation	Open - compensated	-25 ... +70 °C		
		Open	-25 ... +70 °C		
	Storage		-50 ... +85 °C		
	Vibration (acc. to IEC/EN 60068-2-6)		1 g / 3-150 Hz		
	Shock (acc. to IEC/EN 60068-2-27)		15 g / 11 ms		
Auxiliary circuit	Rated operational voltage U_o (acc. to IEC/EN 60947-5-1)		600 V		
	Rated operational current I_o (acc. to IEC/EN 60947-5-1 utilization category)				
	AC-15	110-120 V	N.C.	3 A	
			N.O.	3 A	
		220-230-240 V	N.C.	3 A	
			N.O.	3 A	
		400 V	N.C.	1.1 A	
			N.O.	1.1 A	
	DC-13	24 V	N.C.	0.75 A	
			N.O.	0.75 A	
		110-120-125 V	N.C.	0.55 A	
			N.O.	0.55 A	
	250 V	N.C.	0.27 A		
		N.O.	0.27 A		
Connecting capacity	Main circuit	Rigid	1 or 2 x 1.0 ... 4 mm ²	2.5 ... 16 mm ²	
		Flexible with ferrule	1 or 2 x 0.75 ... 2.5 mm ²	2.5 ... 10 mm ²	
		Flexible without ferrule	1 or 2 x 0.75 ... 2.5 mm ²	2.5 ... 10 mm ²	
		Stripping length		9 mm	13 mm
		Tightening torque		0.8 ... 1.5 Nm	2.3... 2.5 Nm
		Auxiliary circuit	Rigid	1 or 2 x 0.75 ... 2.5 mm ²	
	Flexible with ferrule		1 or 2 x 0.75 ... 2.5 mm ²		
	Flexible without ferrule		1 or 2 x 0.75 ... 2.5 mm ²		
	Stripping length			9 mm	
	Tightening torque		0.8 ... 1.2 Nm		
UL/CSA					
Main circuit	Max. operational voltage		600 V AC		
Connecting capacity	Main circuit	Stranded	1 or 2 x AWG 16 ... 10	AWG 16 ... 6	
		Flexible without ferrule	1 or 2 x AWG 16 ... 10	AWG 16 ... 6	
		Stripping length		9 mm	13 mm
	Tightening torque		7 ... 13 lb.in	20 ... 22 lb.in	
	Auxiliary circuit	Stranded	1 or 2 x AWG 18 ... 10		
		Flexible without ferrule	1 or 2 x AWG 18 ... 10		
Stripping length			9 mm		
Tightening torque		7 ... 11 lb.in			

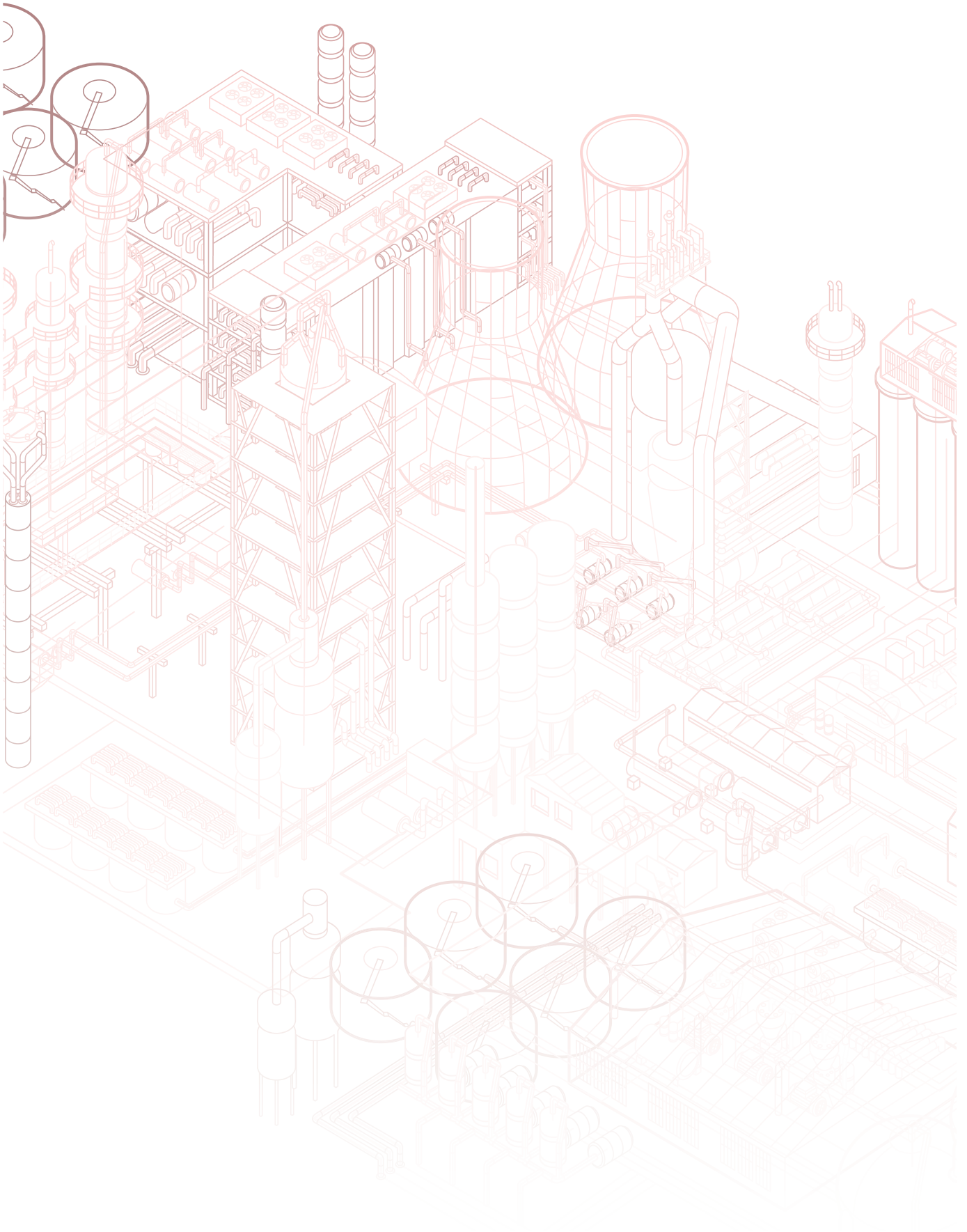

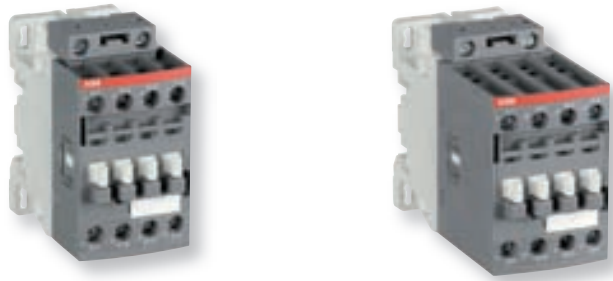

4-pole Contactors



 AC / DC control voltage

AF09	AF16	AF26	AF38
AF09-40-00	AF16-40-00	AF26-40-00	AF38-40-00
AF09-22-00	AF16-22-00	AF26-22-00	AF38-22-00

Switching of Resistive Circuits

	IEC	AC-1	Rated operational current	$\theta \leq 40^\circ\text{C}$	690 V
				$\theta \leq 60^\circ\text{C}$	690 V
With conductor cross-sectional area				$\theta \leq 70^\circ\text{C}$	690 V
	UL/CSA	General use rating		600 V AC	
		With conductor cross-sectional area			

25 A	30 A	45 A	55 A
25 A	30 A	40 A	45 A
22 A	26 A	32 A	37 A
4 mm ²	6 mm ²	10 mm ²	16 mm ²
25 A	30 A	45 A	55 A
AWG 10	AWG 10	AWG 8	AWG 6

Main Accessories

Auxiliary contact blocks

Front mounting 

Side mounting 

Interlocks

Mechanical / electrical 

Mechanical 

1-pole CA4-10 or CA4-01, CC4-10 or CC4-01
4-pole CA4
2-pole CAT4-11 (with coil front connection)
2-pole CAL4-11
VEM4 including VM4 mechanical interlock unit and VE4 electrical interlock block with A2-A2 connection
VM4 including 2 fixing clips

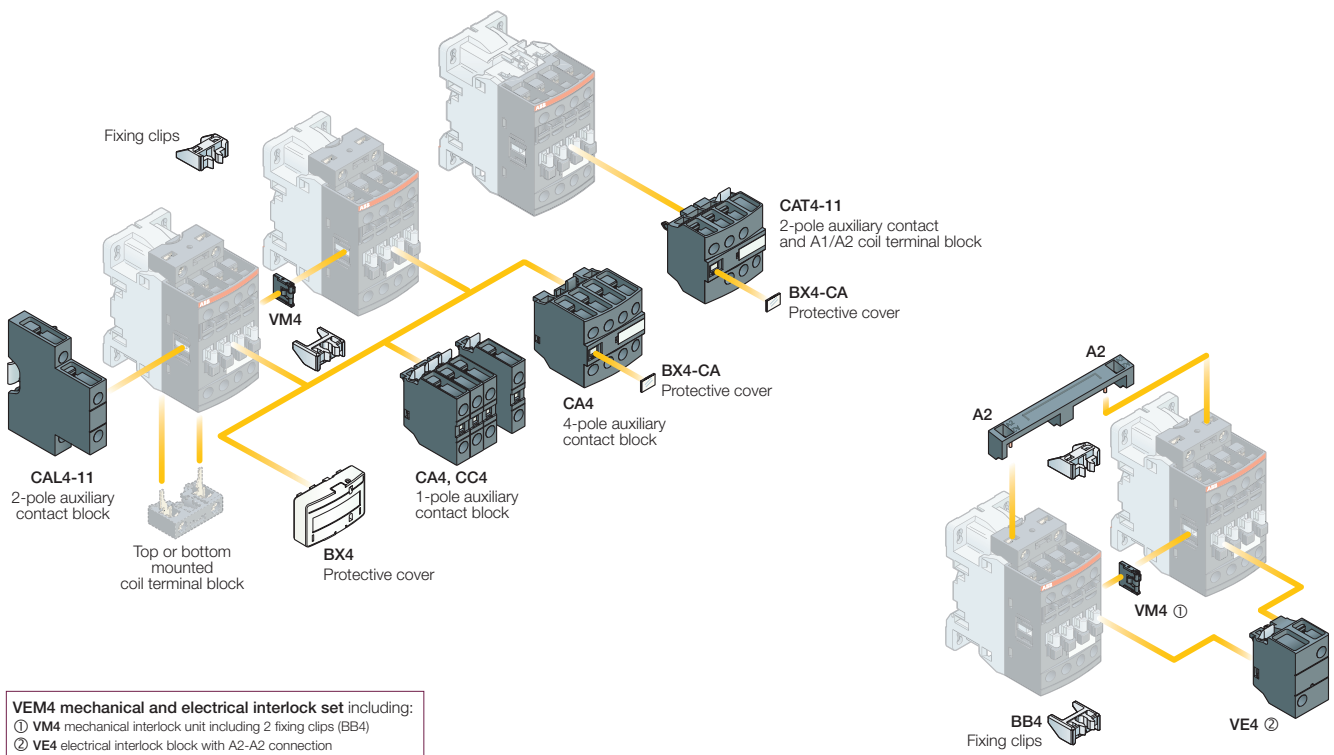

VEM4 mechanical and electrical interlock set including:

- VM4 mechanical interlock unit including 2 fixing clips (BB4)
- VE4 electrical interlock block with A2-A2 connection

AF09 ... AF38 4-pole Contactors

AC / DC Operated - with Screw Terminals



AF09-40-00



AF26-40-00

Application

AF09 ... AF38 4-pole contactors are used for controlling power circuits up to 690 V AC and 440 V DC. They are mainly used for controlling non-inductive or slightly inductive loads (i.e. resistance furnaces...).

Description

- **AF09 ... AF38** contactors include an electronic coil interface accepting a wide control voltage U_c min. ... U_c max. Only four coils cover control voltages between 24...500 V 50/60 Hz or 20...500 V DC
- **AF** contactors can manage large control voltage variations. One coil (e.g. 100...250 V 50/60 Hz - DC) can be used for different control voltages used worldwide without any coil change
- **AF.Z** contactors equipped with a **Z** coil type allow direct control by 24 V DC 500 mA PLC-output and obtain a reduced holding coil consumption. **AF.Z** contactors withstand short voltage dips and voltage sags (SEMI F47-0706 compliance)
- **AF** contactors have built-in surge protection and do not require additional surge suppressors.

Ordering Details

IEC	UL/CSA	Control voltage		Auxiliary contacts fitted	Type	Order code	Weight
AC-1	General use	U_c min. ... U_c max.					Pack ^(ing) 1 piece kg
Rated current $\theta \leq 40^\circ\text{C}$ A	rating 600 V AC A	V 50/60 Hz	V DC				

4 N.O. Main Poles

25	25	24...60	20...60	0 0	AF09Z-40-00-21	1SBL 136 201 R2100	0.310
		48...130	48...130	0 0	AF09-40-00-12	1SBL 137 201 R1200	0.270
		100...250	100...250	0 0	AF09-40-00-13	1SBL 137 201 R1300	0.270
		250...500	250...500	0 0	AF09-40-00-14	1SBL 137 201 R1400	0.310
30	30	24...60	20...60	0 0	AF16Z-40-00-21	1SBL 176 201 R2100	0.310
		48...130	48...130	0 0	AF16-40-00-12	1SBL 177 201 R1200	0.270
		100...250	100...250	0 0	AF16-40-00-13	1SBL 177 201 R1300	0.270
		250...500	250...500	0 0	AF16-40-00-14	1SBL 177 201 R1400	0.310
45	45	24...60	20...60	0 0	AF26Z-40-00-21	1SBL 236 201 R2100	0.400
		48...130	48...130	0 0	AF26-40-00-12	1SBL 237 201 R1200	0.360
		100...250	100...250	0 0	AF26-40-00-13	1SBL 237 201 R1300	0.360
		250...500	250...500	0 0	AF26-40-00-14	1SBL 237 201 R1400	0.400
55	55	24...60	20...60	0 0	AF38Z-40-00-21	1SBL 296 201 R2100	0.400
		48...130	48...130	0 0	AF38-40-00-12	1SBL 297 201 R1200	0.360
		100...250	100...250	0 0	AF38-40-00-13	1SBL 297 201 R1300	0.360
		250...500	250...500	0 0	AF38-40-00-14	1SBL 297 201 R1400	0.400

2 N.O. + 2 N.C. Main Poles

25	25	24...60	20...60	0 0	AF09Z-22-00-21	1SBL 136 501 R2100	0.310
		48...130	48...130	0 0	AF09-22-00-12	1SBL 137 501 R1200	0.270
		100...250	100...250	0 0	AF09-22-00-13	1SBL 137 501 R1300	0.270
		250...500	250...500	0 0	AF09-22-00-14	1SBL 137 501 R1400	0.310
30	30	24...60	20...60	0 0	AF16Z-22-00-21	1SBL 176 501 R2100	0.310
		48...130	48...130	0 0	AF16-22-00-12	1SBL 177 501 R1200	0.270
		100...250	100...250	0 0	AF16-22-00-13	1SBL 177 501 R1300	0.270
		250...500	250...500	0 0	AF16-22-00-14	1SBL 177 501 R1400	0.310
45	45	24...60	20...60	0 0	AF26Z-22-00-21	1SBL 236 501 R2100	0.400
		48...130	48...130	0 0	AF26-22-00-12	1SBL 237 501 R1200	0.360
		100...250	100...250	0 0	AF26-22-00-13	1SBL 237 501 R1300	0.360
		250...500	250...500	0 0	AF26-22-00-14	1SBL 237 501 R1400	0.400
55	55	24...60	20...60	0 0	AF38Z-22-00-21	1SBL 296 501 R2100	0.400
		48...130	48...130	0 0	AF38-22-00-12	1SBL 297 501 R1200	0.360
		100...250	100...250	0 0	AF38-22-00-13	1SBL 297 501 R1300	0.360
		250...500	250...500	0 0	AF38-22-00-14	1SBL 297 501 R1400	0.400

Main Dimensions mm, inches

AF09, AF16

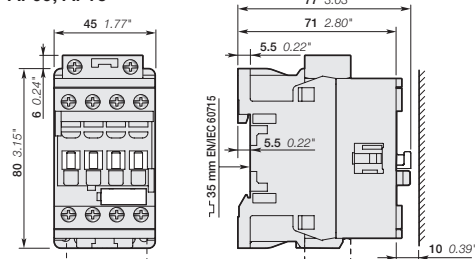

AF26, AF38

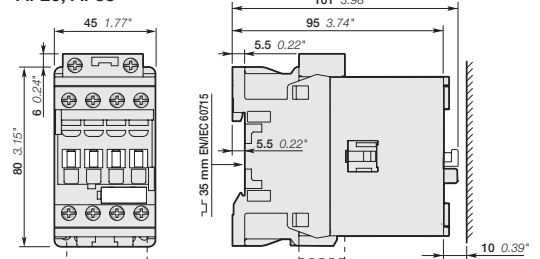

AF09 ... AF38 4-pole Contactors

AC / DC Operated - with Screw Terminals

Catalogue Page 1SBC 101 098 S0201



Main Technical Data

Contactor types		AF09	AF16	AF26	AF38	
Standards		IEC 60947-1 / 60947-4-1 and EN 60947-1 / 60947-4-1, UL 508, CSA C22.2 N°14				
Main poles	Rated operational voltage U_e max.	690 V				
	Rated frequency limits	25 ... 400 Hz				
IEC	I_e / AC-1 rated operational current U_e max. \leq 690 V, 50/60 Hz	$\theta \leq 40$ °C	25 A	30 A	45 A	55 A
		$\theta \leq 60$ °C	25 A	30 A	40 A	45 A
		$\theta \leq 70$ °C	22 A	26 A	32 A	37 A
	with conductor cross-sectional area	4 mm ²	6 mm ²	10 mm ²	16 mm ²	
UL/CSA	General use Amp rating	600 V AC 25 A	30 A	45 A	55 A	
	with conductor cross-sectional area	AWG 10	AWG 10	AWG 8	AWG 6	
Ambient air temperature	Operation in free air	-40 ... +70 °C				
	close to contactor	Storage -60 ... +80 °C				
Magnet system	Coil operating limits (acc. to IEC 60947-4-1)	AC supply	at $\theta \leq 60$ °C $0.85 \times U_c$ min ... $1.1 \times U_c$ max at $\theta \leq 70$ °C $0.85 \times U_c$ min ... U_c max			
		DC supply	at $\theta \leq 60$ °C $0.85 \times U_c$ min ... $1.1 \times U_c$ max at $\theta \leq 70$ °C (AF) $0.85 \times U_c$ min ... U_c max - (AF.Z) $0.85 \times U_c$ min ... $1.1 \times U_c$ max			
AC control voltage	Rated control circuit voltage U_c	24 ... 500 V AC				
50/60 Hz	Coil consumption	Average pull-in value	(AF) 50 VA - (AF.Z) 16 VA			
		Average holding value	(AF) 2.2 VA / 2 W - (AF.Z) 1.7 VA / 1.5 W			
DC control voltage	Rated control circuit voltage U_c	20 ... 500 V DC				
	PLC-output control	(AF.Z) \geq 500 mA 24 V DC				
	Coil consumption	Average pull-in value	(AF) 50 W - (AF.Z) 12 ... 16 W			
		Average holding value	(AF) 2 W - (AF.Z) 1.7 W			
Electromagnetic compatibility		Devices complying with IEC 60947-1 / EN 60947-1 - Environment A				
Connecting capacity	Main pole terminals	Rigid	1 or 2 x	1 ... 6 mm ²	1.5 ... 16 mm ²	
		Flexible with ferrule	1 or 2 x	0.75 ... 6 mm ²	1.5 ... 16 mm ²	
		Capacity acc. to UL/CSA	1 or 2 x	AWG 16 ... 10	AWG 16 ... 6	
		Tightening torque		1.5 Nm / 13 lb.in	2.5 Nm / 22 lb.in	
		Stripping length		10 mm	12 mm	
	Coil terminals	Rigid	1 or 2 x	1 ... 2.5 mm ²		
		Flexible with ferrule	1 or 2 x	0.75 ... 2.5 mm ²		
		Capacity acc. to UL/CSA	1 or 2 x	AWG 18 ... 14		
		Tightening torque		1.2 Nm / 11 lb.in		
		Stripping length		10 mm		
Degree of protection	acc. to IEC 60947-1 / EN 60947-1 and IEC 60529 / EN 60529	IP20				

Remark for 4-pole contactors fitted with 2 N.O. + 2 N.C. main poles

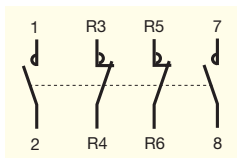

These contactors are suitable for controlling 2 separate circuits, i.e. 2 loads with 2 separate supplies, or 1 circuit comprising 2 separate loads with a single supply (see diagrams below). When the contactor operates there is no mechanical overlapping between the N.O. poles and the N.C. poles: BREAK before MAKE.



These contactors are not suitable for a reversing starter or for controlling a single load from 2 separate supplies.

Block diagrams

- Single supply and 2 separate loads

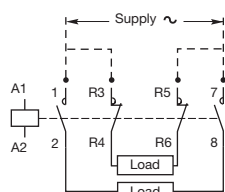

- 2 separate supplies and 2 separate loads

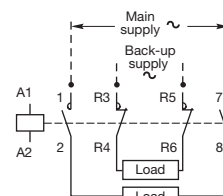

AF09 ... AF38 4-pole Contactors

Main Accessories



Accessory fitting details for a 4-pole contactor AF09 ... AF38

Many configurations of accessories are possible depending on whether these are front-mounted or side-mounted.

Contactor types	Main poles	Built-in auxiliary contacts	Front-mounted accessories				Electrical and mechanical interlock set (between 2 contactors)	Side-mounted accessories	
			Auxiliary contact blocks					Auxiliary contact blocks	
			1-pole CA4				Left side	Right side	
			1-pole CC4	2-pole CAT4-11	4-pole CA4	VEM4	2-pole CAL4-11		
Max. add-on N.C. auxiliary contacts: 4 N.C. max. on positions 1, 2, 3, 4 and 3 N.C. max. on positions 1 ±30°, 5									
AF09, AF16	4	0	0	4 max.	or 1	or 1	-	+ 1	-
				2 max.	or 1	-	-	+ 1	+ 1
				3 max.	-	-	+ 1	+ 1	or 1
Max. add-on N.C. auxiliary contacts: 3 N.C. max. on positions 1, 2, 3, 4 and 2 N.C. max. on positions 1 ±30°, 5									
AF26, AF38	4	0	0	4 max.	or 1	or 1	-	+ 1	-
				2 max.	or 1	-	-	+ 1	+ 1
				3 max.	-	-	+ 1	+ 1	or 1
AF09, AF16	2	2	0	4 max.	or 1	or 1	-	+ 1	-
AF26, AF38	2	2	0	2 max.	or 1	-	-	+ 1	+ 1

Mounting positions



Contactors and main accessories (other accessories available)

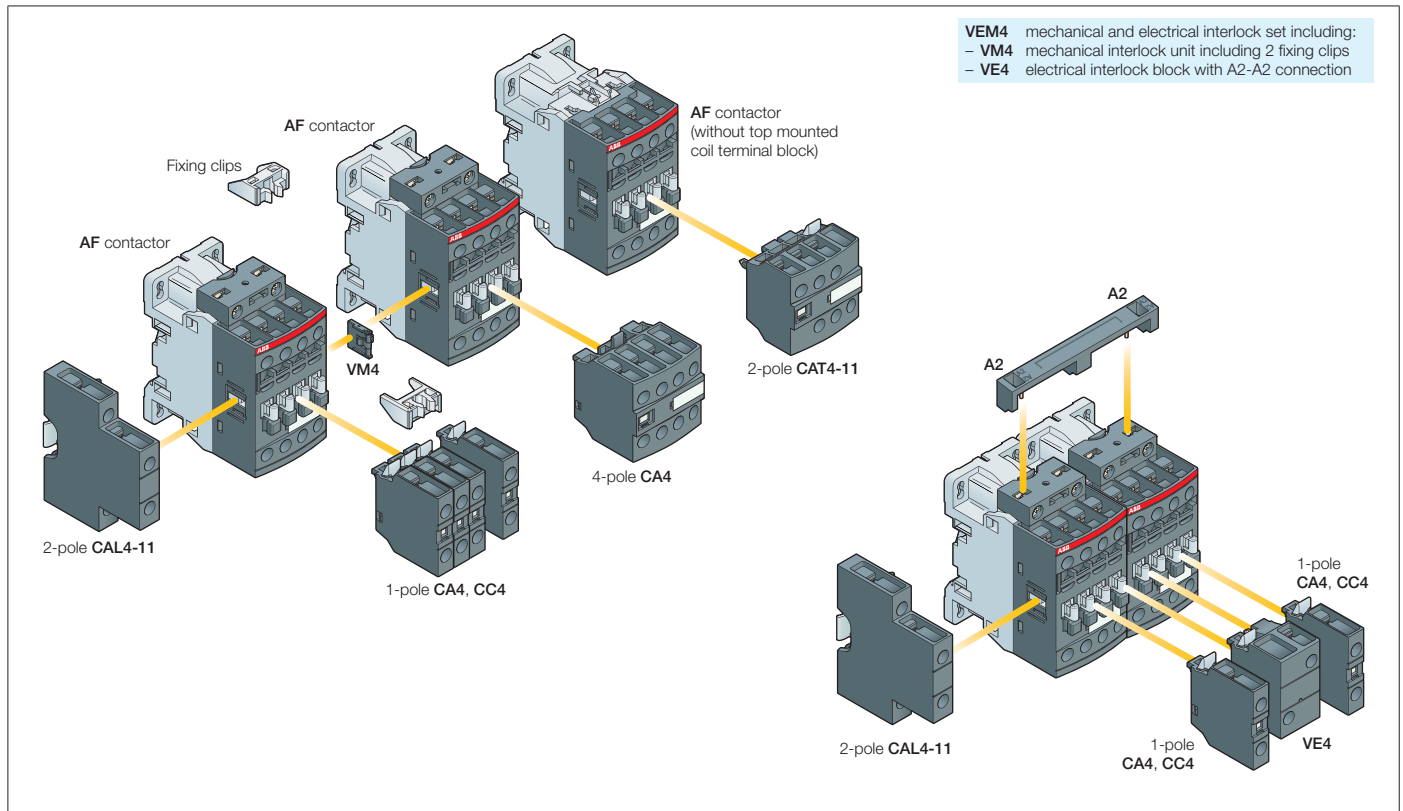

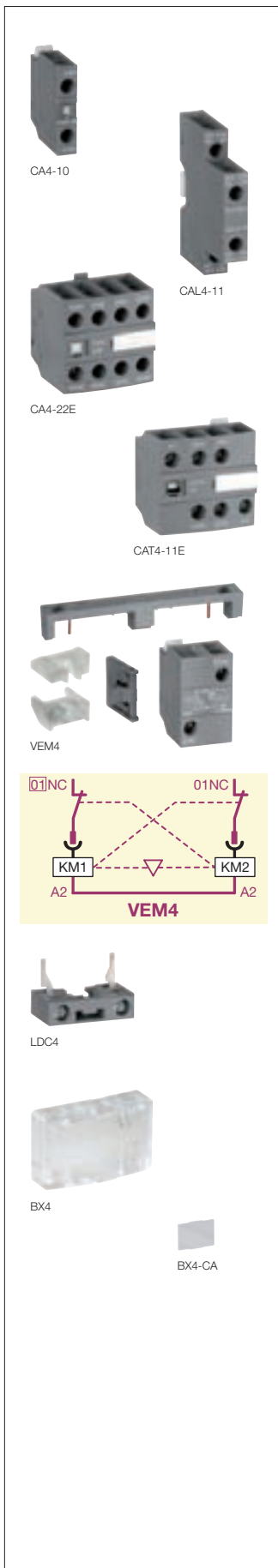

Ordering Details

For contactors	Auxiliary contacts	Type	Order code	Pack ^(ing) pieces	Weight kg (1 poe)

Additional auxiliary contact blocks

Front-mounted instantaneous auxiliary contact blocks

AF09 ... AF38...-40-00	1 0	- -	CA4-10	1SBN 010 110 R1010	1	0.014
AF09 ... AF38...-22-00	1 0	- -	CA4-10-T	1SBN 010 110 T1010	10	0.014
	0 1	- -	CA4-01	1SBN 010 110 R1001	1	0.014
	0 1	- -	CA4-01-T	1SBN 010 110 T1001	10	0.014
	2 2	- -	CA4-22E	1SBN 010 140 R1022	1	0.055
	3 1	- -	CA4-31E	1SBN 010 140 R1031	1	0.055
	4 0	- -	CA4-40E	1SBN 010 140 R1040	1	0.055
AF09 ... AF38...-40-00	0 4	- -	CA4-04E	1SBN 010 140 R1004	1	0.055

Front-mounted auxiliary contact blocks with N.O. leading contact and N.C. lagging contact

AF09 ... AF38...-40-00	- -	1 0	CC4-10	1SBN 010 111 R1010	1	0.014
AF09 ... AF38...-22-00	- -	0 1	CC4-01	1SBN 010 111 R1001	1	0.014

Side-mounted instantaneous auxiliary contact blocks

AF09 ... AF38...-40-00	1 1	- -	CAL4-11	1SBN 010 120 R1011	1	0.040
AF09 ... AF38...-22-00	1 1	- -	CAL4-11-T	1SBN 010 120 T1011	10	0.040

Front-mounted instantaneous auxiliary contact and A1/A2 coil terminal blocks

AF09 ... AF38...-40-00	1 1	- -	CAT4-11E	1SBN 010 151 R1011	1	0.040
AF09 ... AF38...-22-00						

Interlocks

Mechanical interlock unit

AF09 ... AF38...-40-00			VM4	1SBN 030 105 T1000	10	0.005
------------------------	--	--	-----	--------------------	----	-------

Note: VM4 includes 2 fixing clips (BB4) to maintain together both contactors.

Mechanical and electrical interlock set

AF09, AF16...-40-00						
AF26, AF38...-40-00	1 1	- -	VEM4	1SBN 030 111 R1000	1	0.035

Note: VEM4 includes a VM4 mechanical interlock unit with 2 fixing clips (BB4), a VE4 electrical interlock block. VE4 block must be used with A2-A2 connection to respect the electrical connection diagram.

Fixing clips

AF09 ... AF38...-40-00			BB4	1SBN 110 120 W1000	50	0.002
------------------------	--	--	-----	--------------------	----	-------

Additional coil terminal block

AF09 ... AF38			LDC4	1SBN 070 156 T1000	10	0.010
---------------	--	--	------	--------------------	----	-------

Protective covers

All 1-stack contactors			BX4	1SBN 110 108 T1000	10	0.006
For 4-pole CA4 and 2-pole CAT4 auxiliary contact blocks			BX4-CA	1SBN 110 109 W1000	50	0.001

AF09, AF16 4-pole Contactors

AC / DC Operated - with Screw Terminals



Dimensions mm, inches

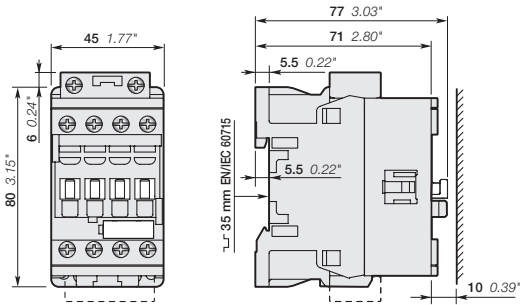

AF09, AF16

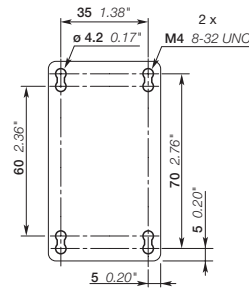

AF09, AF16

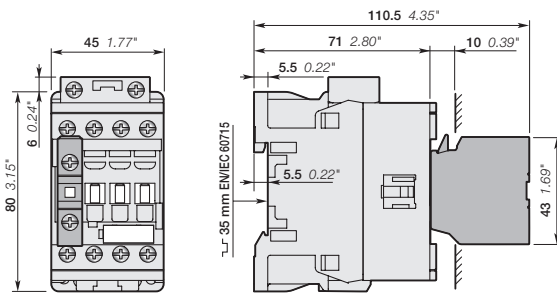

AF09, AF16
+ CA4, CC4 1-pole auxiliary contact block

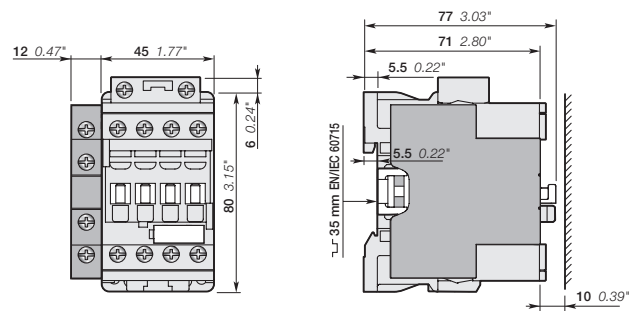

AF09, AF16
+ CAL4-11 2-pole auxiliary contact block

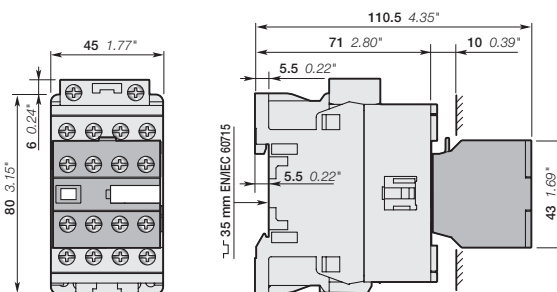

AF09, AF16
+ CA4 4-pole auxiliary contact block

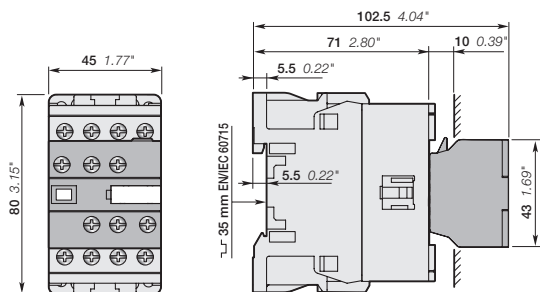

AF09, AF16
+ CAT4 2-pole auxiliary contact and coil terminal block

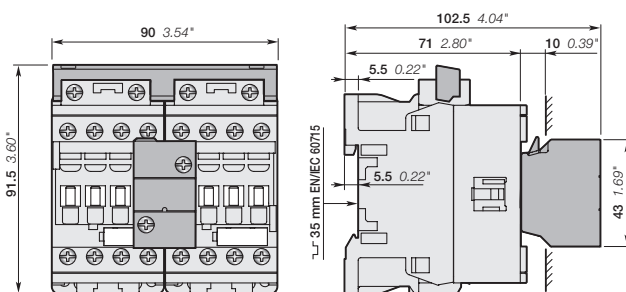

AF09..-40-00, AF16..-40-00
+ VEM4 mechanical and electrical interlock set

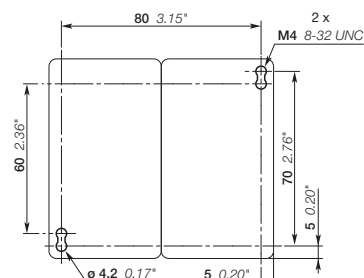

AF09..-40-00, AF16..-40-00
+ VEM4 mechanical and electrical interlock set

Note: contactor lateral distance to grounded component 2 mm 0.08" min.

AF26, AF38 4-pole Contactors

AC / DC Operated - with Screw Terminals



Dimensions mm, inches

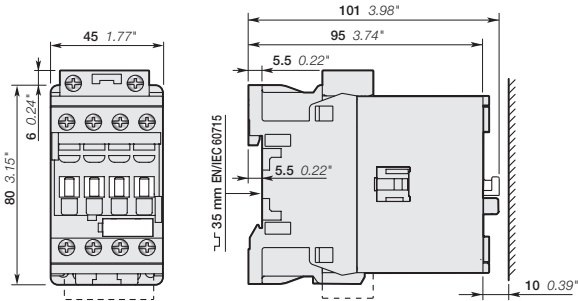

AF26, AF38

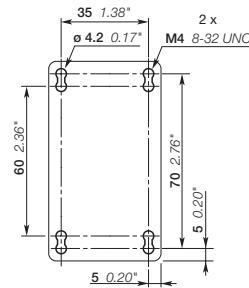

AF26, AF38

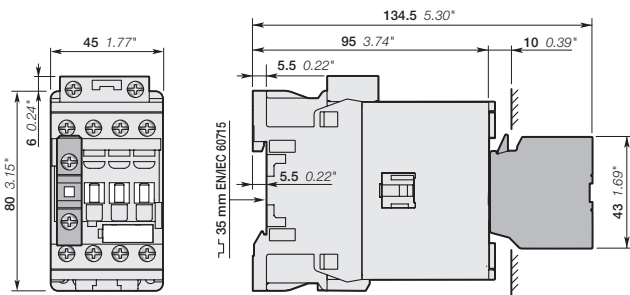

AF26, AF38
+ CA4, CC4 1-pole auxiliary contact block

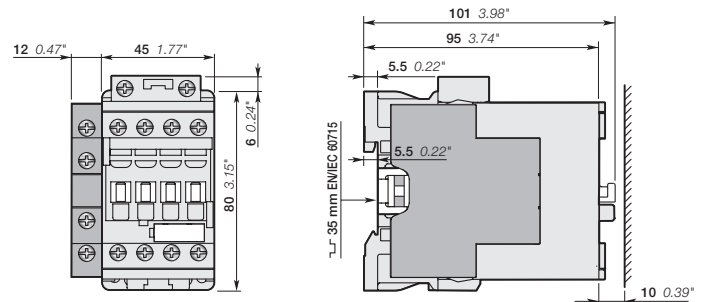

AF26, AF38
+ CAL4-11 2-pole auxiliary contact block

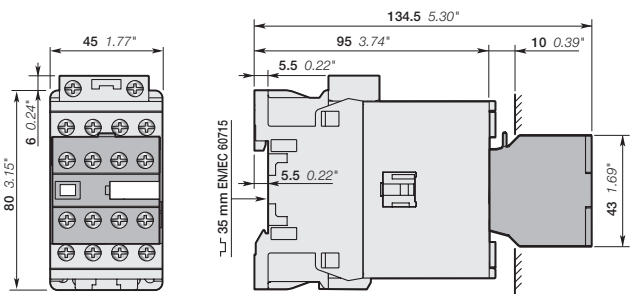

AF26, AF38
+ CA4 4-pole auxiliary contact block

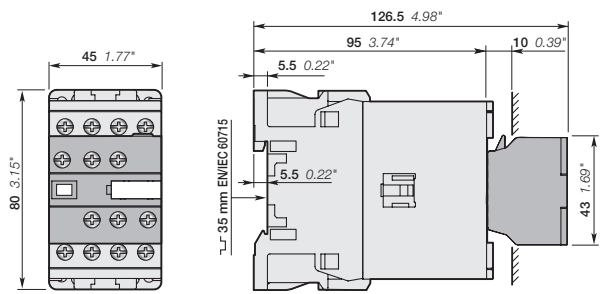

AF26, AF38
+ CAT4 2-pole auxiliary contact and coil terminal block

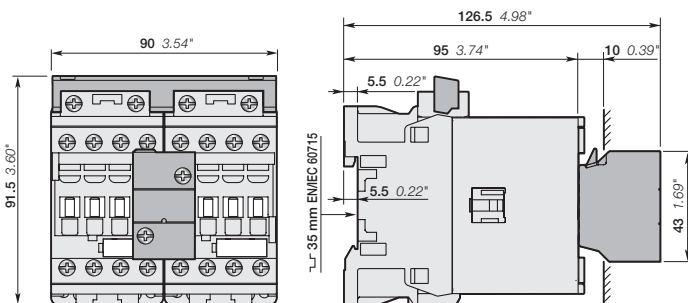

AF26..-40-00, AF38..-40-00
+ VEM4 mechanical and electrical interlock set

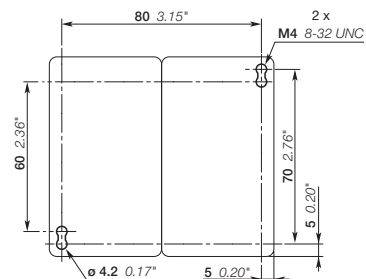

AF26..-40-00, AF38..-40-00
+ VEM4 mechanical and electrical interlock set

Note: contactor lateral distance to grounded component 2 mm 0.08" min.

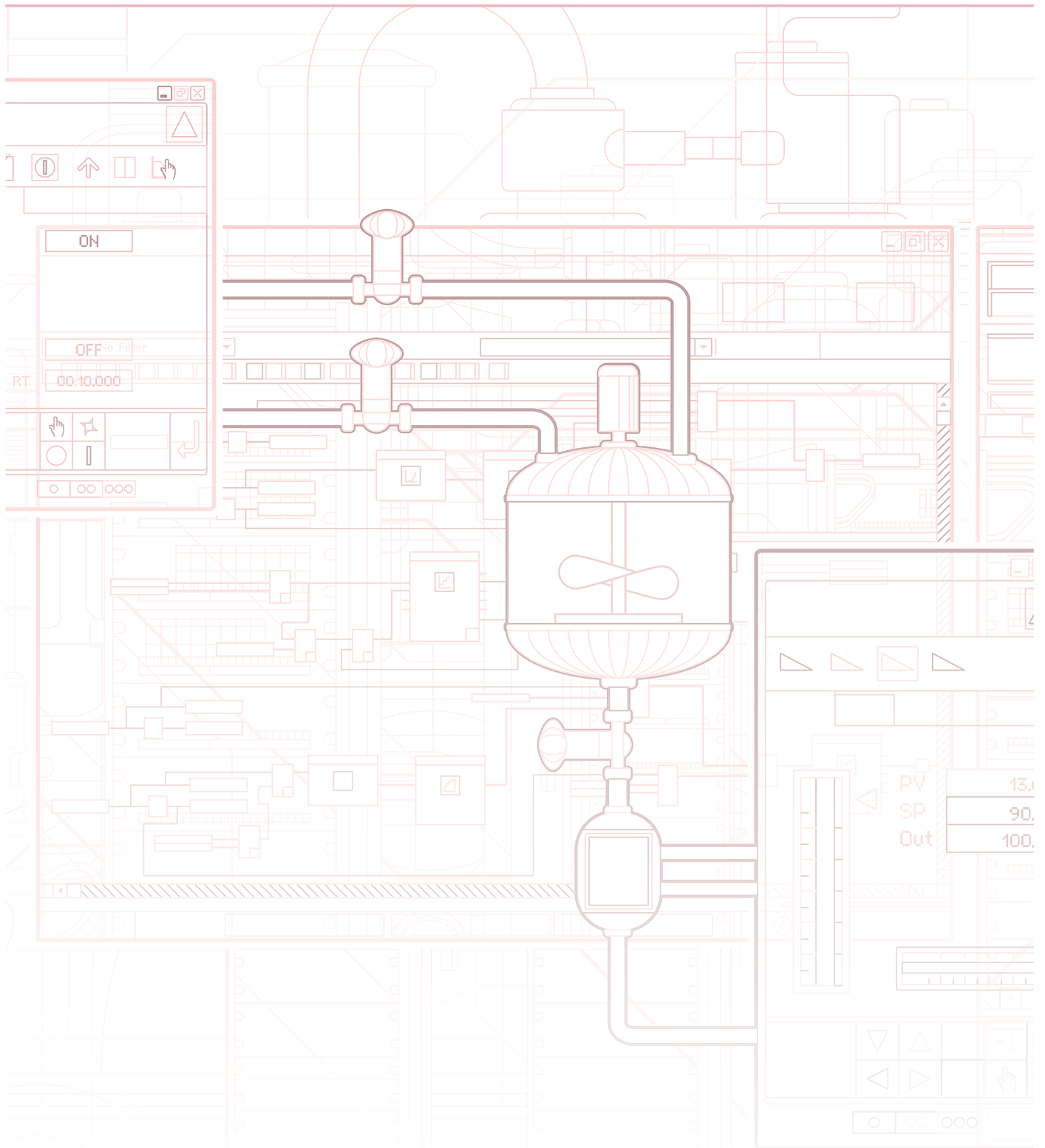

Contactor Relays



 AC / DC control voltage

NF22E	NF31E	NF40E
2 N.O. + 2 N.C.	3 N.O. + 1 N.C.	4 N.O.

Control Circuit Switching

Rated operational current			
IEC	AC-15	240 V	4 A
		400 V	3 A
		690 V	2 A
	DC-13	24 V	6 A / 144 W
		400 V	0.15 A / 60 W
UL/CSA	Pilot Duty		A600, Q600

Main Accessories

Auxiliary contact blocks	Front mounting	1-pole CA4-10 or CA4-01, CC4-10 or CC4-01
		4-pole CA4
	Side mounting	2-pole CAL4

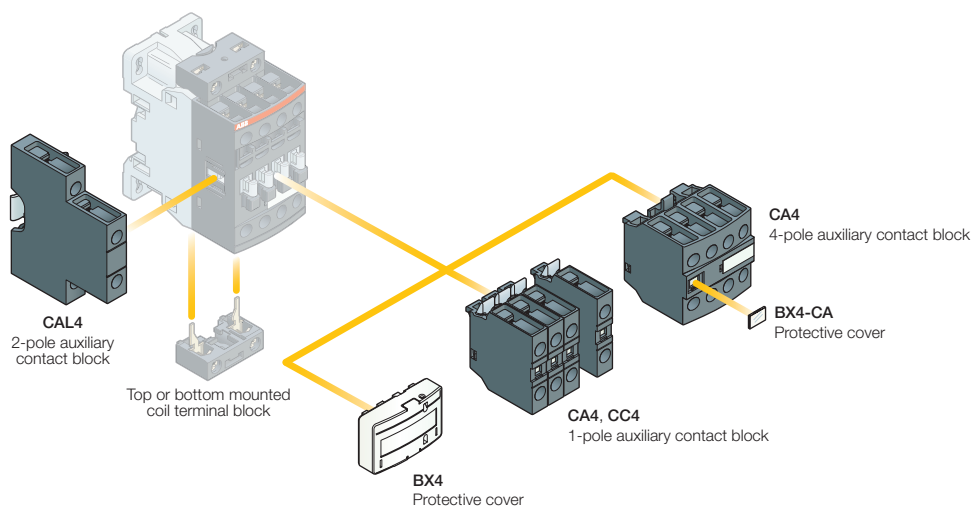

NF Contactor Relays

AC / DC Operated - with Screw Terminals



NF22E



Application

NF contactor relays are used for switching auxiliary and control circuits.

Description

- NF contactor relays include an electronic coil interface accepting a wide control voltage U_c min. ... U_c max. Only four coils cover control voltages between 24...500 V 50/60 Hz or 20...500 V DC
- NF contactor relays can manage large control voltage variations. One coil (e.g. 100...250 V 50/60 Hz - DC) can be used for different control voltages used worldwide without any coil change
- NFZ contactor relays equipped with a Z coil type allow direct control by 24 V DC 500 mA PLC-output and obtain a reduced holding coil consumption.
- NFZ contactor relays withstand short voltage dips and voltage sags (SEMI F47-0706 compliance)
- NF contactor relays have built-in surge protection and do not require additional surge suppressors
- The contactor relays have mechanically-linked auxiliary contacts compliant with Annex L of IEC 60947-5-1 and include the "Mechanically Linked" symbol on their side.

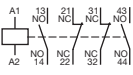
Ordering Details

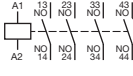
Number of contacts 1 st stack	Control voltage U_c min. ... U_c max.		Type	Order code	Weight Pack ^(ng) 1 piece kg
	V 50/60 Hz	V DC			
	24...60	20...60	NFZ22E-21	1SBH 136 001 R2122	0.310
	48...130	48...130	NF22E-12	1SBH 137 001 R1222	0.270
	100...250	100...250	NF22E-13	1SBH 137 001 R1322	0.270
	250...500	250...500	NF22E-14	1SBH 137 001 R1422	0.310
	24...60	20...60	NFZ31E-21	1SBH 136 001 R2131	0.310
	48...130	48...130	NF31E-12	1SBH 137 001 R1231	0.270
	100...250	100...250	NF31E-13	1SBH 137 001 R1331	0.270
	250...500	250...500	NF31E-14	1SBH 137 001 R1431	0.310
	24...60	20...60	NFZ40E-21	1SBH 136 001 R2140	0.310
	48...130	48...130	NF40E-12	1SBH 137 001 R1240	0.270
	100...250	100...250	NF40E-13	1SBH 137 001 R1340	0.270
	250...500	250...500	NF40E-14	1SBH 137 001 R1440	0.310

Main Dimensions mm, inches

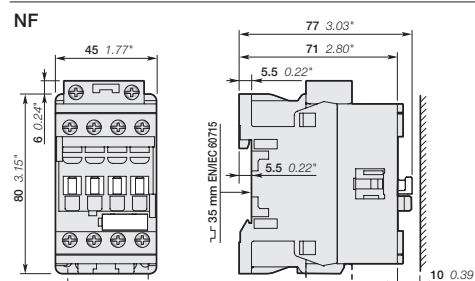

NF Contactor Relays

AC / DC Operated - with Screw Terminals



Main Technical Data

Contactor relay types		NF		
Standards		IEC 60947-5-1 and EN 60947-5-1, UL 508, CSA C22.2 N°14		
Main poles IEC	Rated operational voltage U_g max.	690 V		
	Rated frequency limits	25 ... 400 Hz		
	Conventional free-air thermal current I_{th} acc. to IEC 60947-5-1, open contactors, $\theta \leq 40$ °C	16 A		
	Rated operational current I_g / AC-15 acc. to IEC 60947-5-1	24-127 V 50/60 Hz	6 A	
		220-240 V 50/60 Hz	4 A	
		400-440 V 50/60 Hz	3 A	
		500 V 50/60 Hz	2 A	
		690 V 50/60 Hz	2 A	
	Rated operational current I_g / DC-13 acc. to IEC 60947-5-1	24 V DC	6 A / 144 W	
		48 V DC	2.8 A / 134 W	
72 V DC		1 A / 72 W		
110 V DC		0.55 A / 60 W		
125 V DC		0.55 A / 69 W		
220 V DC		0.27 A / 60 W		
250 V DC		0.27 A / 68 W		
400 V DC		0.15 A / 60 W		
500 V DC		0.13 A / 65 W		
600 V DC	0.1 A / 60 W			
UL/CSA	Max. rated voltage	600 V AC, 600 V DC		
	Pilot Duty	A600, Q600		
Short-circuit protection gG type fuse		10 A		
Ambient air temperature close to contactor relay	Operation in free air	-40 ... +70 °C		
	Storage	-60 ... +80 °C		
Magnet system (acc. to IEC 60947-5-1)	Coil operating limits	AC supply	at $\theta \leq 60$ °C $0.85 \times U_c$ min ... $1.1 \times U_c$ max at $\theta \leq 70$ °C $0.85 \times U_c$ min ... U_c max	
		DC supply	at $\theta \leq 60$ °C $0.85 \times U_c$ min ... $1.1 \times U_c$ max at $\theta \leq 70$ °C (NF) $0.85 \times U_c$ min ... U_c max - (NFZ) $0.85 \times U_c$ min ... $1.1 \times U_c$ max	
AC control voltage 50/60 Hz	Rated control circuit voltage U_c	24 ... 500 V AC		
	Coil consumption	Average pull-in value	(NF) 50 VA - (NFZ) 16 VA	
		Average holding value	(NF) 2.2 VA / 2 W - (NFZ) 1.7 VA / 1.5 W	
DC control voltage	Rated control circuit voltage U_c	20 ... 500 V DC		
	PLC-output control	(NFZ) ≥ 500 mA 24 V DC		
	Coil consumption	Average pull-in value	(NF) 50 W - (NFZ) 12 ... 16 W	
		Average holding value	(NF) 2 W - (NFZ) 1.7 W	
Electromagnetic compatibility		Devices complying with IEC 60947-1 / EN 60947-1 - Environment A		
Connecting capacity	Main pole terminals	Rigid	1 or 2 x 1 ... 2.5 mm ²	
		Flexible with ferrule	1 or 2 x 0.75 ... 2.5 mm ²	
		Capacity acc. to UL/CSA	1 or 2 x AWG 18 ... 14	
		Tightening torque	1.2 Nm / 11 lb.in	
		Stripping length	10 mm	
	Coil terminals	Rigid	1 or 2 x 1 ... 2.5 mm ²	
		Flexible with ferrule	1 or 2 x 0.75 ... 2.5 mm ²	
		Capacity acc. to UL/CSA	1 or 2 x AWG 18 ... 14	
		Tightening torque	1.2 Nm / 11 lb.in	
		Stripping length	10 mm	
Degree of protection	acc. to IEC 60947-1 / EN 60947-1 and IEC 60529 / EN 60529	IP 20		



Accessory fitting details for a NF contactor relay

Many configurations of accessories are possible depending on whether these are front-mounted or side-mounted.

Contactor relay types	Main poles	Front-mounted accessories		Side-mounted accessories	
		Auxiliary contact blocks		Auxiliary contact blocks	
		1-pole CA4 1-pole CC4	4-pole CA4	Left side 2-pole CAL4-11	Right side
Max. add-on N.C. auxiliary contacts: 3 N.C. max. on positions 1, 2, 3, 4 and 2 N.C. max. on positions 1 ±30°, 5					
NF..	2 2 E	4 max.	or 1	+ 1	-
NF..	3 1 E	2 max.	-	+ 1	+ 1
Max. add-on N.C. auxiliary contacts: 4 N.C. max. on positions 1, 2, 3, 4 and 3 N.C. max. on positions 1 ±30°, 5					
NF..	4 0 E	4 max.	or 1	+ 1	-
		2 max.	-	+ 1	+ 1

Mounting positions



Contactor relays and main accessories (other accessories available)

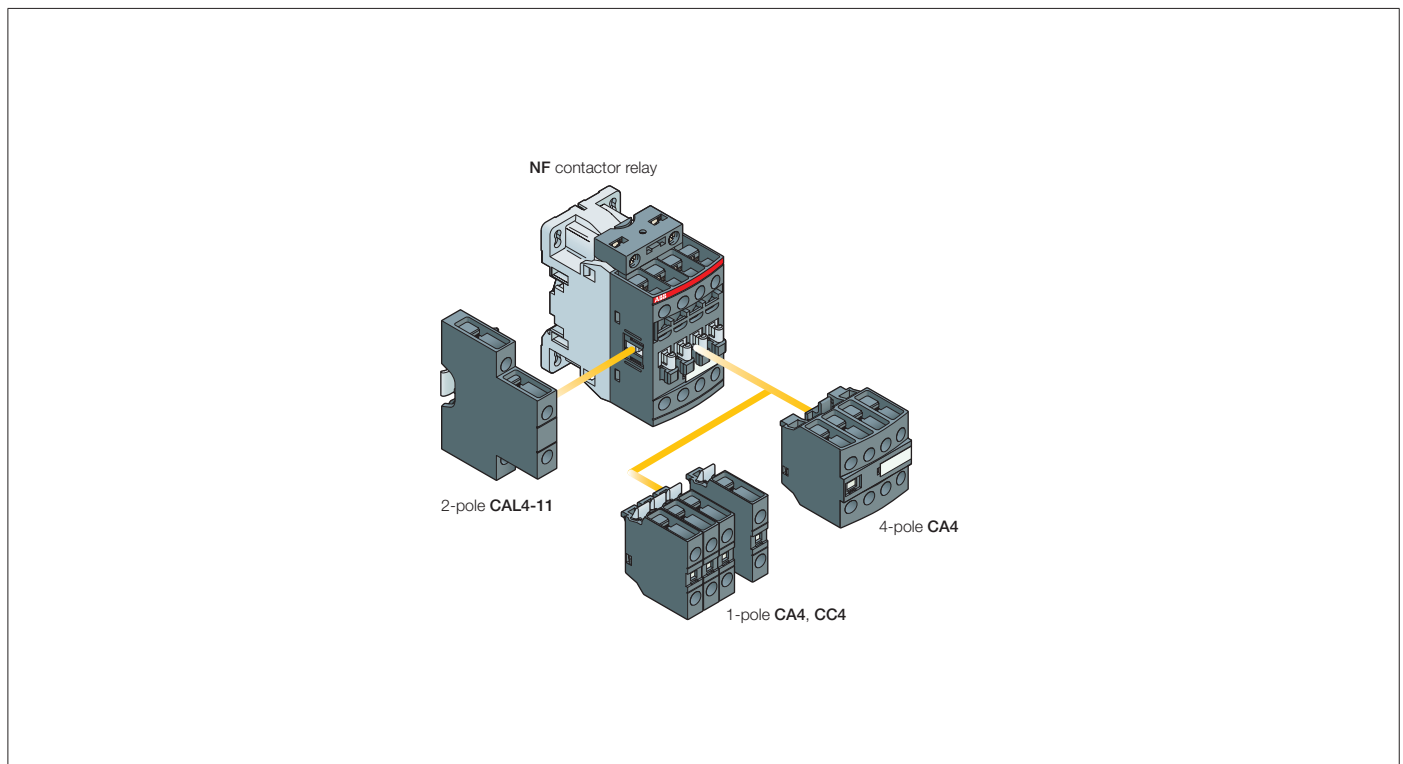

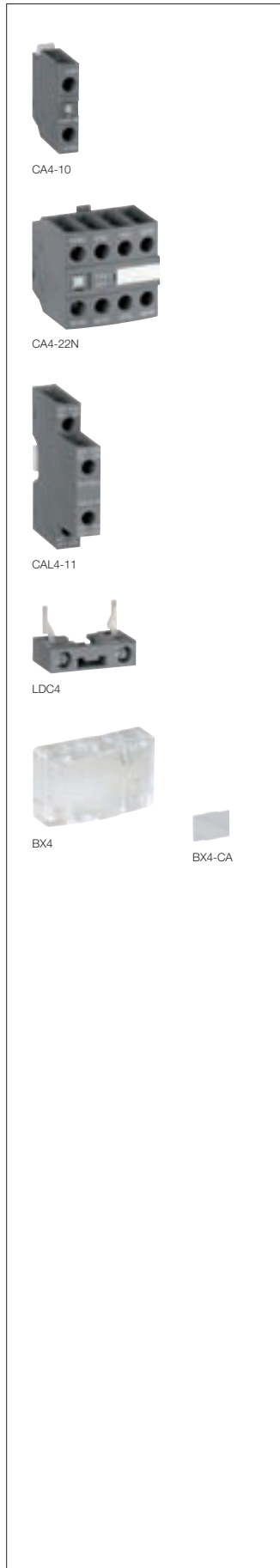

Ordering Details

For contactor relays	Auxiliary contacts	Type	Order code	Pack ^(ing) pieces	Weight kg (1 pce)

Additional auxiliary contact blocks

Front-mounted instantaneous auxiliary contact blocks

4-pole NF			Type	Order code	Pack ^(ing) pieces	Weight kg
	1 0	- -	CA4-10	1SBN 010 110 R1010	1	0.014
	1 0	- -	CA4-10-T	1SBN 010 110 T1010	10	0.014
	0 1	- -	CA4-01	1SBN 010 110 R1001	1	0.014
	0 1	- -	CA4-01-T	1SBN 010 110 T1001	10	0.014
	4 0	- -	CA4-40N	1SBN 010 140 R1240	1	0.055
	3 1	- -	CA4-31N	1SBN 010 140 R1231	1	0.055
	2 2	- -	CA4-22N	1SBN 010 140 R1222	1	0.055
	1 3	- -	CA4-13N	1SBN 010 140 R1213	1	0.055
NF.40E	0 4	- -	CA4-04N	1SBN 010 140 R1204	1	0.055

Front-mounted auxiliary contact blocks with N.O. leading contact and N.C. lagging contact

4-pole NF			Type	Order code	Pack ^(ing) pieces	Weight kg
	- -	1 0	CC4-10	1SBN 010 111 R1010	1	0.014
	- -	0 1	CC4-01	1SBN 010 111 R1001	1	0.014

Side-mounted instantaneous auxiliary contact blocks

NF			Type	Order code	Pack ^(ing) pieces	Weight kg
	1 1	- -	CAL4-11	1SBN 010 120 R1011	1	0.040
	1 1	- -	CAL4-11-T	1SBN 010 120 T1011	10	0.040

Additional coil terminal block

NF	Type	Order code	Pack ^(ing) pieces	Weight kg
	LDC4	1SBN 070 156 T1000	10	0.010

Protective covers

	Type	Order code	Pack ^(ing) pieces	Weight kg
All 1-stack contactor relays	BX4	1SBN 110 108 T1000	10	0.006
For 4-pole CA4 auxiliary contact blocks	BX4-CA	1SBN 110 109 W1000	50	0.001

NF Contactor Relays

AC / DC Operated - with Screw Terminals



Dimensions mm, inches

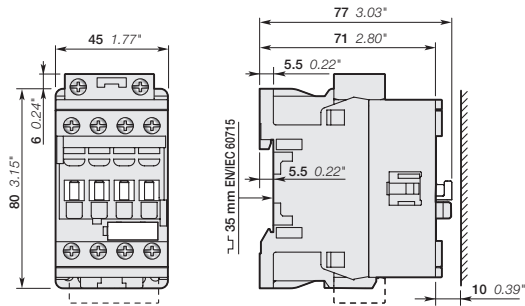

NF..22E, NF..31E, NF..40E

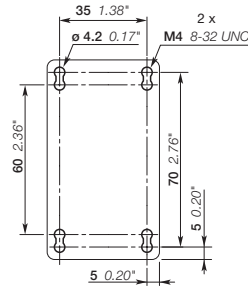

NF..22E, NF..31E, NF..40E

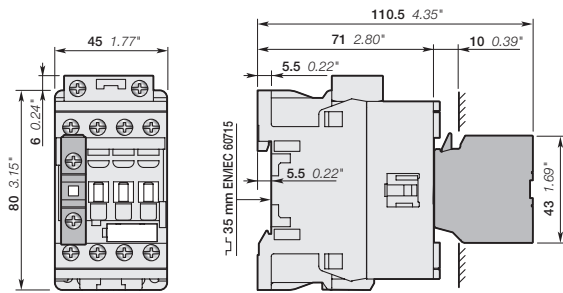

NF..22E, NF..31E, NF..40E
+ CA4, CC4 1-pole auxiliary contact block

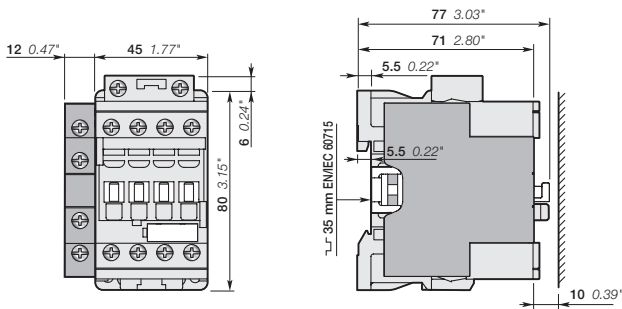

NF..22E, NF..31E, NF..40E
+ CAL4-11 2-pole auxiliary contact block

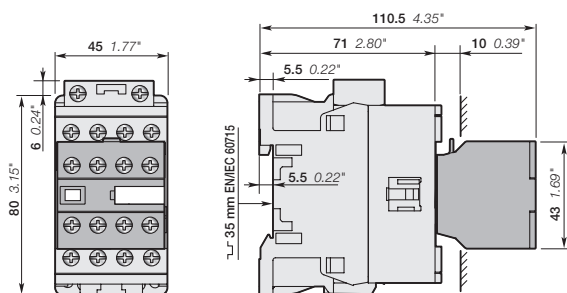

NF..22E, NF..31E, NF..40E
+ CA4 4-pole auxiliary contact block

Note: contactor relay lateral distance to grounded component 2 mm 0.08" min.

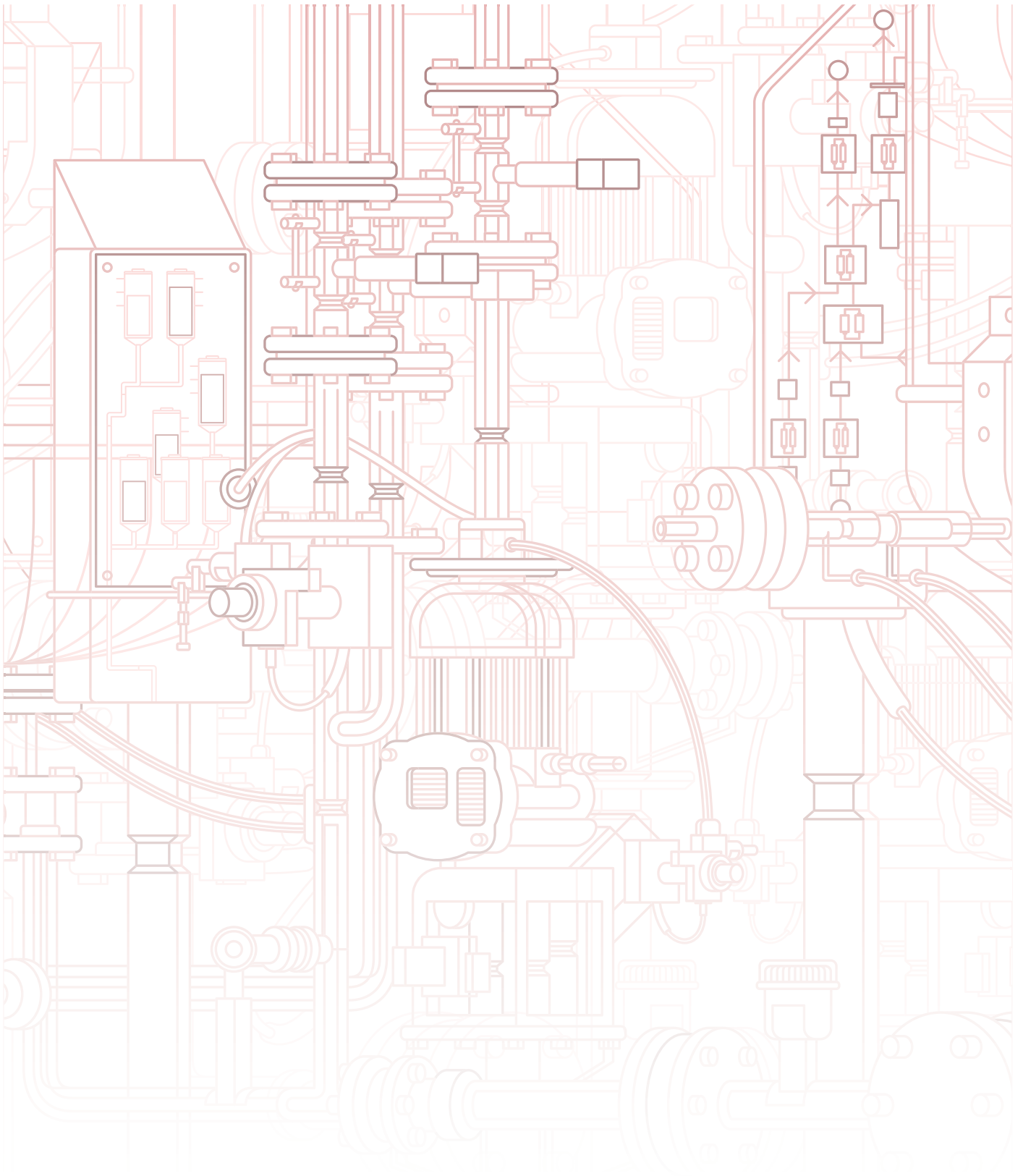

PSR3 ... PSR37 Softstarters

AC or DC Operated

		1.5 to 18.5 kW
		2 to 25 hp



PSR3 ... PSR16



PSR25 ... PSR30



PSR37

Application

Softstarters from **PSR3** up to **PSR37** are used for starting and stopping normal standard three phase motors. All applications benefit from soft starting as it reduces the starting current and limits the mechanical stresses when starting, giving the equipment a long life.

One of the most common applications is for the operation of pumps, where soft stopping can be used to avoid water hammering and damage to pipes.

Other common applications are for starting fans, compressors, conveyors, mixers and tooling machines.

Description

PSR softstarters reduce the main voltage during-start using electronically-controlled semiconductors. The **PSR** softstarters offer a very compact design thanks to the built-in by-pass contacts in the main circuit. Wide main voltage range from 208 to 600 V limits the need of variants as well as being very robust and insensitive for voltage variations. The range from 3 A up to 37 A is designed in three frame sizes. The compact design, clear marking and limited need for control wiring makes it easy to install.

Types

The **PSR** range offers types with 24 V DC as well as a 100...240 V AC supply voltage.

The complete range has a run signal contact, while sizes **PSR25 ... PSR37** also have a top of ramp signal (T.O.R.) indicating the end of the start run. Each size of the **PSR** softstarters can be combined with our manual motor starters (MMS) using the connection kits. This will result in a very compact starter combination.

Ordering Details

IEC Rated power 400 V AC-3 kW	UL/CSA 3-phase motor rating 480 V hp	Supply and control voltage		Auxiliary contacts		Type	Order code	Weight Pack ^(ng) 1 piece kg
		V AC 50/60 Hz	V DC	Run	T.O.R.			
1.5	2	100...240	-	1	-	PSR3-600-70	1SFA 896 103 R7000	0.450
		-	24	1	-	PSR3-600-81	1SFA 896 103 R8100	0.450
3	3	100...240	-	1	-	PSR6-600-70	1SFA 896 104 R7000	0.450
		-	24	1	-	PSR6-600-81	1SFA 896 104 R8100	0.450
4	5	100...240	-	1	-	PSR9-600-70	1SFA 896 105 R7000	0.450
		-	24	1	-	PSR9-600-81	1SFA 896 105 R8100	0.450
5.5	7.5	100...240	-	1	-	PSR12-600-70	1SFA 896 106 R7000	0.450
		-	24	1	-	PSR12-600-81	1SFA 896 106 R8100	0.450
7.5	10	100...240	-	1	-	PSR16-600-70	1SFA 896 107 R7000	0.450
		-	24	1	-	PSR16-600-81	1SFA 896 107 R8100	0.450
11	15	100...240	-	1	1	PSR25-600-70	1SFA 896 108 R7000	0.650
		-	24	1	1	PSR25-600-81	1SFA 896 108 R8100	0.650
15	20	100...240	-	1	1	PSR30-600-70	1SFA 896 109 R7000	0.650
		-	24	1	1	PSR30-600-81	1SFA 896 109 R8100	0.650
18.5	25	100...240	-	1	1	PSR37-600-70	1SFA 896 110 R7000	1.000
		-	24	1	1	PSR37-600-81	1SFA 896 110 R8100	1.000

Main Dimensions mm, inches

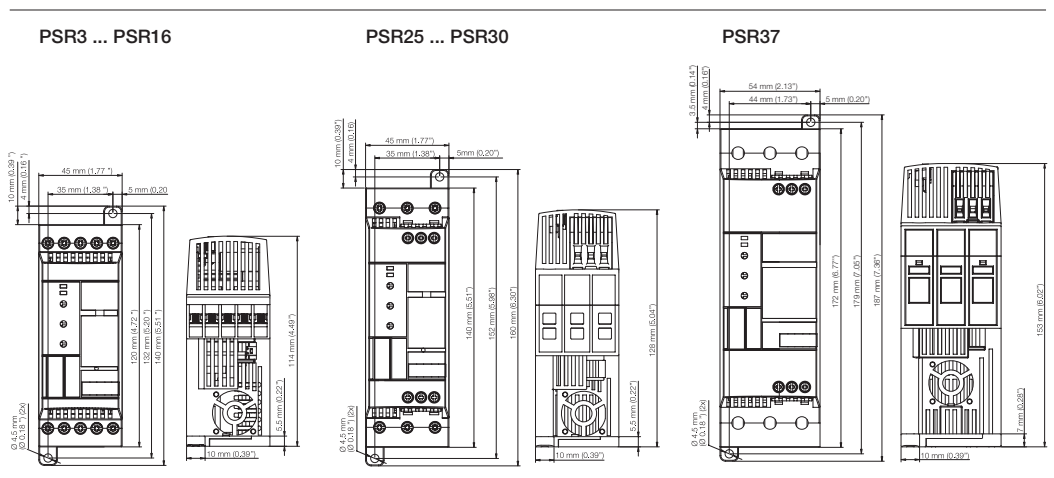

PSR3 ... PSR37 Softstarters

AC or DC Operated

Catalogue Page 1SBC 101 102 S0201



Main Technical Data

For complete technical data see 1SFC132005C0201

Softstarter types		PSR3	PSR6	PSR9	PSR12	PSR16	PSR25	PSR30	PSR37	
Standards		Devices complying with IEC 60947-1 / 60947-4-2 and EN 60947-1 / 60947-4-2								
Main poles	Rated operational voltage U_s max.	600 V								
	Rated frequency limits	AC 50 ... 60 Hz								
IEC	I_s max. rated operational current for ambient temperature of 40 °C ⁽¹⁾	3.6 A	6.5 A	8.5 A	11.5 A	15.5 A	22 A	29 A	35 A	
	AC-53a rated operational power	380-400 V	1.5 kW	3 kW	4 kW	5.5 kW	7.5 kW	11 kW	15 kW	18.5 kW
UL/CSA	3-phase motor power	440-480 V	2 hp	3 hp	5 hp	7.5 hp	10 hp	15 hp	20 hp	25 hp
	(for 1500 r.p.m., 50 Hz or 1800 r.p.m., 60 Hz)									
	FLA		3.4 A	6.1 A	9 A	11 A	15.2 A	24.2 A	28 A	34 A
Starting capacity at I_s		4 x I_s for 6 sec.								
Number of starts per hour										
	standard	10 ⁽¹⁾								
	with aux. fan	20 ⁽¹⁾								
Ambient air temperature	Operation	-25 ... +60 °C ⁽²⁾								
	Storage	-40 ... +70 °C								
Supply & control voltage	Operating limits	AC supply	0.85 x U_s min ... 1.1 x U_s max							
		DC supply	0.85 x U_s min ... 1.1 x U_s max							
AC supply 50/60 Hz	Rated control circuit voltage U_c	100 ... 240 V AC								
	Power consumption	12 VA								
DC supply	Rated control circuit voltage U_c	24 V DC								
	Power consumption	5 W								
Electromagnetic compatibility		Devices complying with IEC 60947-1 / EN 60947-1								
Built-in aux. contacts	Rated operational voltage U_s max.	240 V						250 V		
	IEC I_s / AC-15 rated operational current	0.5 A								
Connecting capacity	Main pole terminals	Rigid	1 x	0.75 ... 2.5 mm ²				2.5 ... 10 mm ²		6 ... 35 mm ²
			2 x	0.75 ... 2.5 mm ²				2.5 ... 10 mm ²		6 ... 16 mm ²
		Flexible with ferrule	1 x	0.75 ... 2.5 mm ²				2.5 ... 10 mm ²		6 ... 35 mm ²
			2 x	0.75 ... 2.5 mm ²				2.5 ... 10 mm ²		6 ... 16 mm ²
	Capacity acc. to UL/CSA		1 or 2 x	AWG 18 ... 10				AWG 10 ... 6		AWG 8 ... 4
	Supply terminals	Rigid	1 x	0.75 ... 2.5 mm ²				0.75 ... 2.5 mm ²		
			2 x	0.75 ... 2.5 mm ²				0.75 ... 1.5 mm ²		
		Flexible with ferrule	1 x	0.75 ... 1.5 mm ²				0.75 ... 2.5 mm ²		
2 x			0.75 ... 1.5 mm ²				0.75 ... 1.5 mm ²			
Capacity acc. to UL/CSA		1 or 2 x	AWG 18 ... 10				AWG 18 ... 12			
Degree of protection	acc. to IEC 60947-1 / EN 60947-1 and IEC 60529 / EN 60529		IP 20						IP 10	
LED	for ON/Ready		Green							
	for Run/Top Of Ramp		Green							
Settings	Ramp time during start		1-20 sec.							
	Ramp time during stop		0-20 sec.							
	Initial -and End Voltage		40-70%							

(1) Valid for 50% on the time and 50% off time. 4 x I_s for 6 sec., if other data is required, contact your sales office

(2) Above 40 °C up to max. 60 °C reduce the rated current with 0.8% per °C



Ordering Details

Description	Type	Order code	Pack ^(ing) pieces	Weight kg (1 pce)
Field bus Plug Connection Accessory The same accessory for all sizes	PS-FBPA	1SFA 896 312 R1002	1	0.060
Connection kit for PSR3-16 and MS116	PSR16-MS116	1SFA 896 211 R1001	1	0.030
Connection kit for PSR25-30 and MS132	PSR30-MS132	1SFA 896 212 R1001	1	0.030
Connection kit for PSR37-45 and MS450	PSR45-MS450	1SFA 896 213 R1001	1	0.030
Fan for PSR3...PSR37	PSR-FAN3-45	1SFA 896 311 R1001	1	0.010



PS-FBPA

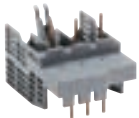

PSR16-MS116



PSR45-MS450



PSR-FAN3-45



Dimensions mm, inches

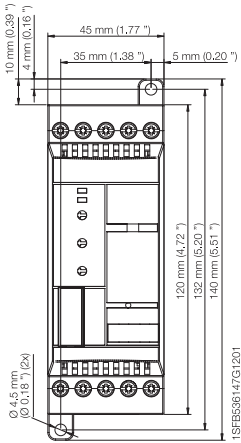

PSR3...PSR16

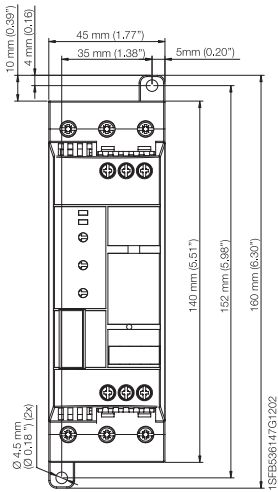
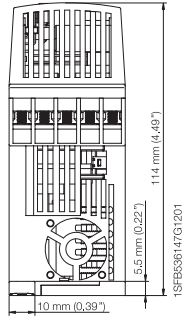

PSR25...PSR30

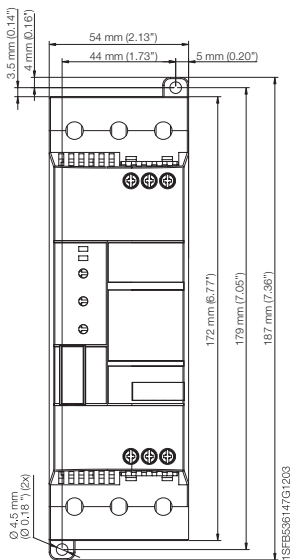
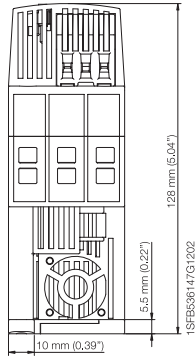

PSR37

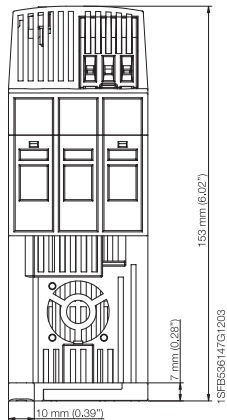

Contact us

ABB France

Low Voltage Products Division

10, rue Ampère Z.I. - B.P. 114
F-69685 Chassieu cedex / France

ABB STOTZ-KONTAKT GmbH

Eppelheimer Straße 82
D-69123 Heidelberg / Germany

ABB AB/ Cewe-Control

Motorgränd 20
S-721 61 Västerås / Sweden

You can find the address of your local sales organisation
on the ABB home page

<http://www.abb.com/contacts> -> Low Voltage products

Note

We reserve the right to make technical changes or modify the contents of this document without prior notice. With regard to purchase orders, the agreed particulars shall prevail. ABB does not accept any responsibility whatsoever for potential errors or possible lack of information in this document.

We reserve all rights in this document and in the subject matter and illustrations contained therein. Any reproduction, disclosure to third parties or utilization of its contents – in whole or in parts – is forbidden without prior written consent of ABB.

Copyright© 2011 ABB
All rights reserved